

ZAXIS-3 series

HITACHI

ZAXIS
130



HYDRAULIC EXCAVATOR

- **Model Code** : ZX130-3 / ZX130LCN-3
- **Engine Rated Power** : 69 kW (93 HP)
- **Operating Weight** : ZX130-3 : 12 500 - 13 600 kg
ZX130LCN-3 : 12 700 - 13 700 kg
- **Backhoe Bucket** : SAE, PCSA Heaped : 0.19 - 0.66 m³
CECE Heaped : 0.17 - 0.55 m³

The Power to Perform

The ZAXIS-3 series is a new generation of excavators designed to provide more efficient power, productivity and improved operator comfort. By listening carefully to the wishes of the end-user, HITACHI not only understands your business, but also provides the reliable solutions you've been looking for.

NEW AND IMPROVED

- **Performance:**
5% higher production
- **Comfort:**
Excellent visibility
Enhanced controllability
Lower noise level
- **New equipment:**
Standard satellite communication system
Standard rear view camera
Standard theft deterrent system
- **Reduced running costs:**
Lower fuel consumption per m³
Improved durability and reliability



Productivity

New E-mode
HIOS II hydraulic system
New electronic controlled diesel engine
Page 4-5

Operator comfort

High visibility inside cab
Short stroke levers
Wide foot space
Comfort designed seat
Improved controlability and operator comfort
Page 6-7

Multi function monitor

Maintenance support
Attachment support system
Rear view camera
Theft deterrent system
Fuel consumption monitoring
Page 8-9

Durability and reliability

Strengthened X beam
Improved idler brackets
Strengthened front attachment
Page 10-11

Maintenance

Conveniently located inspection points
Parallel arrangement of the cooling pack
Page 12-13

Safety measures

CRES II cab
Cab right protection bars
Pilot control shut-off lever
Engine shut-off switch
Page 14

Environment measures

Array of low noise mechanisms
Ecological design
Page 15

Parts & service

Page 16

e-Service Owner's site

Page 17

Specifications

Page 19-28

- **The new engine complies with the Emission Regulations EU Stage III A**
- **The advanced low noise design complies with the coming EU noise regulation 2000 / 14 / EC, STAGE II**



Notes : Some of the pictures in this catalog show an unmanned machine with attachments in an operating position. These were taken for demonstration purposes only and the actions shown are not recommended under normal operating conditions.



Boosted Productivity

New hydraulic system HIOS II and new DOHC 4-valve diesel engine were developed for ZAXIS-3. These advanced technologies are at work to yield bigger output with higher fuel efficiency.

More production, less fuel consumption

Increased Production

A combination of the hydraulic system (HIOS*II) and new DOHC 4-valve engine allows the efficient use of hydraulic pressure to increase speeds of actuators and boost production with higher fuel efficiency. The productivity is increased 5% in comparison to previous model ZAXIS-1.

**Human & Intelligent Operation System*

New E-mode

The new E mode, H/P mode and P mode can be selected to suit job needs. The new E mode can save fuel consumption by up to 8% compared to the previous model's P mode, while yielding similar production.

Sophisticated Travel Control

At climbing or steering, when the machine needs more traction force, the engine speed automatically increases which makes the machine faster.

Efficient hydraulic control - HIOS II

HIOS II Hydraulic System

The HIOS II hydraulic system elicits more user satisfaction than other models on the market due to its greater operator comfort and ease of operability. Our ZAXIS-3 model not only adopts this technology but also improves it, adding several enhancements over previous models. It offers a balance between the operability of the front attachment arm and its manoeuvring speed, resulting in an improved capacity to handle combined operations with maximum stability during excavation.

Development concept of new engine

DOHC* 4-Valve Engine

The new DOHC 4-valve diesel engine is developed and built to comply with the rigorous Emission Regulations enforced in 2008 in U.S and EU. This new engine contributes to environmental preservation. At the same time it realizes high durability and low fuel consumption by adapting the latest advanced engine technology.

**Double Overhead camshaft*

Common Rail Type Fuel Injection System

Electronic control common rail type fuel injection system drives an integrated fuel pump at an ultrahigh pressure to distribute fuel to each injector per cylinder through a common rail. This enables optimum combustion to generate big horsepower, and reduce PM* (diesel plume) and fuel consumption.

**Particulate Matter*

Cooled EGR* System

The cooled EGR system lets part of exhaust gasses mix with intake air for re-combustion to reduce oxygen concentration in the air in the combustion chamber. This design lowers combustion temperature in the cylinder, reducing fuel consumption and NOx while yielding more horsepower.

**Exhaust Gas Recirculation*

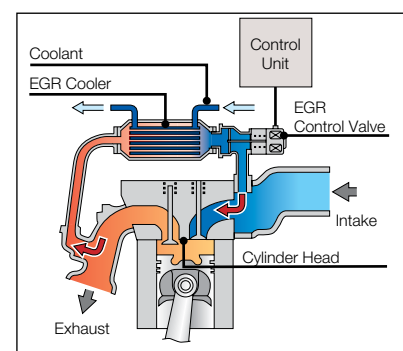
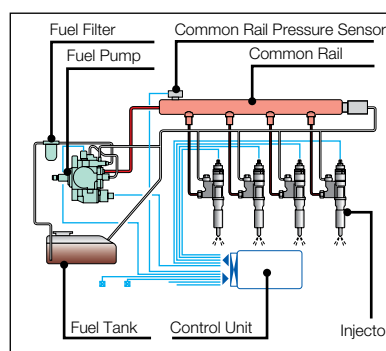

A New Standard in Operator Comfort

The operator's seat of the ZAXIS-3 series gives the operator an excellent view of the jobsite. On the widescreen colour LCD monitor the operator can see what is behind the machine. Ample legroom, short stroke levers and a large seat ensure optimum working conditions for the operator during long hours.



The photo shows an excavator with an optional blade(blade lever) installed.



The photo shows an excavator with an optional blade(blade lever) installed.

The ZAXIS-3 series cab has been redesigned to meet demands of customers. From the operator's seat the operator has an excellent view of the jobsite. On the widescreen color LCD monitor the operator can see machine conditions and with the rear view camera, what is behind the machine. Ample legroom, short stroke levers and a suspension seat with heating ensure optimum working conditions. The seat features horizontal, vertical adjustments and has a backrest contoured for comfort, with a HITACHI logo.



Wide adjustable armrests and a retractable seat belt are included. Short stroke levers allow for continuous operation with less fatigue. Three switches on the lever (optional) can be set to operate attachments other than buckets. The cab is pressurized to keep out dust. Noise and vibrations are kept to a minimum due to the elastic mounts, filled with silicone oil, the cab rests on.

Visibility is improved especially for the right downward view. Sliding windows on the front and side enable direct communication between operator and other workers. Foot space has increased and travel pedals have been redesigned for easier operation. A flat floor allows for easy cleaning. Ergonomic controls and switches, fully automatic air conditioner and a radio complete the package.

Embedded Information Technology

The ZAXIS-3 series is equipped with a widescreen color LCD monitor with adjustable contrast for day and night shifts. With the monitor the operator can check maintenance intervals, select work modes, monitor fuel consumption, and connect to the rear view camera. A theft deterrent system and multi-language selection is also available.

Multi function monitor



The color LCD monitor, located in the cab, indicates coolant temperature, fuel level, and maintenance data. It also allows one-touch adjustment of the attachment. The display can also be adjusted to day or night shift.

Attachment support system (work mode selector)



When replacing the attachment, oil flow adjustment can automatically be done by one touch on the work mode selection display on the LCD monitor. Minor adjustments of oil flow is possible if necessary.

Maintenance support

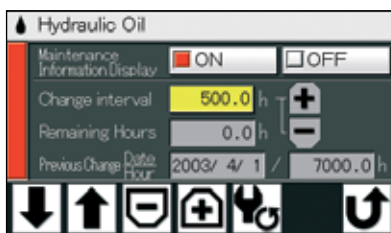
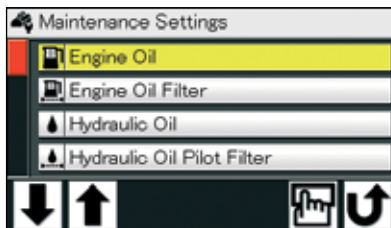

Replacement timing of hydraulic oil and fuel filters is alerted to the operator through the LCD monitor according to the schedule preset by the user each time when turning the key switch. The scheduled maintenance can prevent the failure of the machine.

Multi-language selection



The menu allows selection from 12 languages.





Rear view camera



The widescreen color LCD, in tandem with the rear view camera on the counterweight, provides a convenient view of the area behind the unit. The rear view camera automatically works when traveling backward, and can also be manually turned on with a select switch on the monitor.

Theft deterrent system



The electronic immobiliser requires the entry of an encryption code to the multifunctional monitor each time when starting the engine to prevent theft and vandalism.

Fuel consumption monitoring

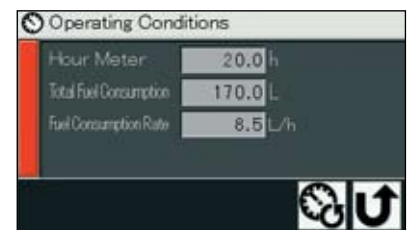

Fuel consumption per operating hour is computed, and the result is displayed on the LCD monitor. This information suggests refuelling timing, and guides energy-saving operation and efficient job management.

**The indicated values are examples and could differ from those in actual operation.*

A Solid Base for a Long Life

HITACHI's technology is built on a wealth of experience and know-how from a variety of demanding conditions around the world. The undercarriage of the ZAXIS 110 has become much stronger. Improved construction and enlarged box sections, a track undercover plate that protects the center joint and hydraulic hoses make this machine more durable.



Strengthened X beam and side frames

The X-beam is strengthened by the improved construction and enlarged box sections. Top and bottom plates of the X-beam use monolithic plates, instead of conventional welded four plates. This eliminates welding to strengthen the X-beam.

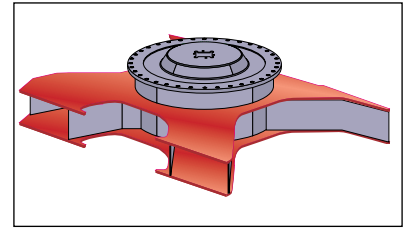

Strengthened idler brackets

The idler bracket is widened.
Reinforcing plate is also attached to prevent the opening of the idler bracket.

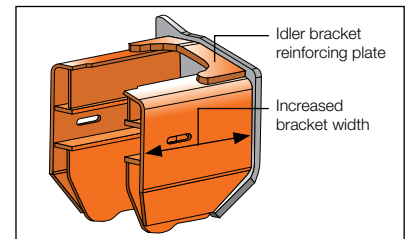

Strengthened front attachment

At arm-bucket joint, the arm top is hardened with WC thermal spraying (Tungsten-Carbide) for greater wear resistance at its contact surface with bucket, reducing jerking. Reinforced resin thrust plates designed to reduce noise and resist wear.

The new HN bushings, containing "solid molybdenum-based lubricant", are utilized at the boom-arm joint and arm cylinder mounting area for better lubrication and higher durability. (At other joints, conventional HN bushings are also utilized.)

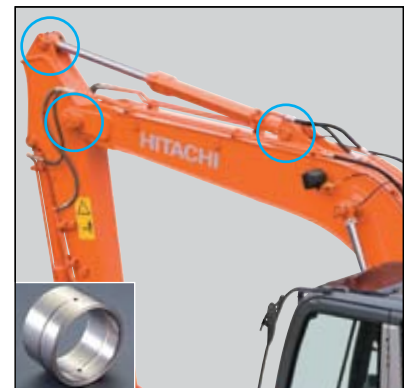

New HN bushing



WC Thermal spraying



Reinforced resin thrust plates

Simplified Maintenance

The ZAXIS-3 series meet customer demands for simplified maintenance. Regular maintenance is the key for keeping equipment in top condition, which can help to prevent costly downtime. In addition, a regular serviced machine has higher residual value. There are many service features to be found on the ZAXIS-3 series.



Conveniently located inspection points



Wide doors give access, from ground level, to the fuel filter, water separator and engine oil filter. A large handrail, steps and anti-skid plates lead to the engine cover. The engine oil pan is fitted with a drain coupler. When draining, an associated drain hose is connected to the drain coupler. The drain coupler is reliable, avoiding oil leakage and vandalism.

The fresh air filter for the air conditioner is relocated to cab door side from conventional location behind the operator seat. This allows easy cleaning and replacement of the fresh air filter, like the air circulation filter inside the cab.

Parallel arrangement of the cooling pack



The oil cooler, radiator and intercooler are laid out in a parallel arrangement, instead of the conventional in-line arrangement. This parallel arrangement is significantly easier to clean around the radiator.

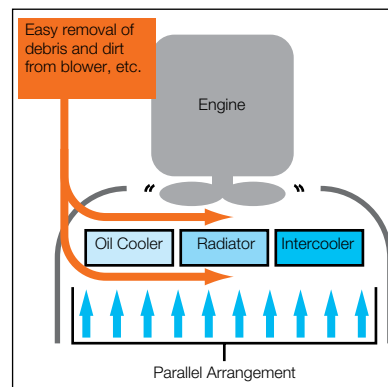

Extended oil and filter change intervals

Front Pin Lubricating Intervals and Consumables Replacement		
		New ZAXIS 130
Lubricant	Bucket	500 h
	Boom Foot	500 h
	Front	500 h
Consumables	Engine Oil	500 h
	Engine Oil Filter	500 h
	Hydraulic Oil	5 000 h
	Hydraulic Oil Filter	1 000 h
	Fuel Filter	500 h

The oil and filter change intervals have been extended considerably, reducing maintenance time and expenses. Engine oil consumption is lower. Hydraulic oil can be used up to 5 000 hours.

Safety Features

Ensuring the safety of the operator and other workers on the jobsite is an important concern for HITACHI. That is why the ZAXIS-3 series has a number of safety features including a new reinforced cab and shut-off mechanisms for engine and pilot controls.

CRES II cab

The CRES II cab is designed to help with “just in case” protection for the operator. Safety in case of tipping is improved. The cab top, for instance, can withstand about 2.5 times conventional load when side load is applied to the cab top until its deformation reaches 200 mm.



Withstanding load : 2.5-fold increase

Additional features

Cab right protection bars



Evacuation hammer



Engine shut-off switch



Pilot control shut-off lever

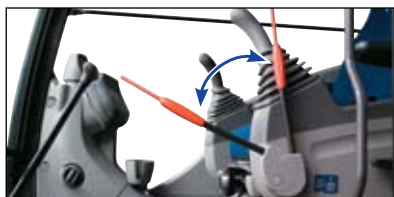

OPG Top Guard, Level II



(optional)

Retractable seat belt



Other features include a retractable seatbelt, evacuation hammer and emergency engine shut-off switch. A shut-off lever for pilot control helps to prevent unintentional movements. In addition an Operator Protective Guard (OPG top guard, Level II) is optionally available. For the cab windows there is a choice of laminated or tempered glass.

Environmental Features

HITACHI acts responsibly when it comes to the environment. Our production facilities have ISO 14001 certification. The HITACHI machine is lead free and has a low-noise design, therefore HITACHI customers get one of the most environmentally considerate hydraulic excavators available today.



A cleaner machine

The ZAXIS-3 series is equipped with a clean but powerful engine to comply with Tier 3, and Stage III A. An engine emission regulations effective in the U.S. EPA and European Union from 2008. Exhaust gas is partly re-combusted to reduce particulate matter (PM) output and lower nitrogen oxide (NOx) levels.



A quieter machine

A number of features make this machine quieter. First, isochronous control of the engine speed means a restriction of engine speed during no-load and light-duty operation to suppress sound. A fan with curved blades reduces air resistance and air flow noise. Third, a time-tested muffler suppresses engine noise significantly.



A recyclable machine

All resin parts are marked to facilitate recycling. The machine is completely lead-free. The radiator and oil cooler are made from aluminium and all wires are lead-less. In addition, biodegradable hydraulic oil is available for jobsites where special environmental care is required.



Parts & Service

Over the years, we have gained experience in one of the most competitive service markets in the world - Japan. Using our know-how in dealing directly with customers, we have created a worldwide support system that is highly capable.

Parts

HITACHI only offers genuine high quality parts. We guarantee that these parts have high performance and long life. We manage around 1 000 000 types of parts all around the world. They are designed and built to be the best match for your HITACHI equipment. HITACHI has a global parts distribution network that makes sure you get what you need

as quickly as possible. We have more than 150 dealers worldwide who provide the closest support for your needs. In most cases, your dealer will have the replacement part that you require. If a dealer does not have a certain part, he can order it from four fully stocked parts depots located across the world. These distribution centres are all con-

nected by an on-line system that gives them access to shared information on stocks, such as the number and type of available parts. The depots, which in turn are stocked by a parts center in Japan, minimize delivery time and enable you to get your parts as efficiently and quickly as possible.

Service

Our goal is to “keep customer equipment at a maximum performance level”. To fulfil this goal, we have set more than 150 dealers all over the world. They have highly trained technicians, and provide a number of support programs. HITACHI provides a unique extended warranty program called HITACHI Extended Life Program, or HELP.

To minimize downtime during troubleshooting, we developed a PDA based diagnostic system called “Dr.ZX”. To keep our customers’ equipment in top running shape, good service is indispensable. We believe personnel training is the key to providing the best service.

If you would like more information regarding parts and/or service, please ask your nearest HITACHI dealer. Not all programs and/or services are available in every market or region.

Remote fleet management with e-Service Owner's Site

OWNER'S

e-Service Owner's Site

Reduce maintenance effort and costs for your machine fleet with e-Service Owner's Site; latest machine information of each of your machines available on-line, in your office.

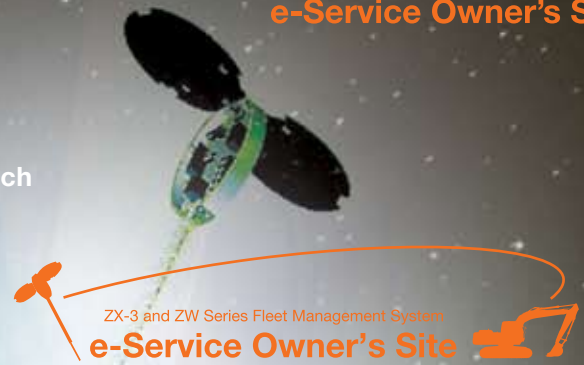

e-Service Owner's Site features

Operation

Remote access to all relevant machine operation information such as daily operating hours and machine fuel level as well as historically cumulated temperatures and pressures.

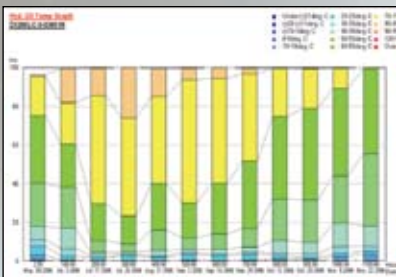

Maintenance

For each machine, maintenance history as well as recommended maintenance due is displayed in one view, allowing for accurate and efficient fleet maintenance management.



Location

In addition to any general GPS function, GIS (Geographical Information System) will not only show the geographical position of each machine with immediate serial number identification, it will also allow for dedicated multiple machine searches using specific operational information as search criteria.



Check and monitor each of your machines from your office

Enhanced service support from your local dealer

Actual geographical location of each of your machines

e-Service Owner's Site is an on-line fleet management tool offered by HCME to each of its customers. It will present all operational information and location of your machines on a PC in your office, giving you an up to date overview of your machines, allowing for full fleet control. Each machine will regularly send its operational data to a satellite and from there, via a ground station to a Hitachi server. The data collected in the server will then be processed and directed to each customer around the world. Your machine information will be available through a secure internet connection for you and your dealer. This communication chain is operational 24h a day, each day of the year. It will support your job planning, help you maintain your machine and allow for enhanced service and trouble shooting support by your local dealer, all directly contributing to reduce downtime and increase the cost performance of your fleet.

All new ZAXIS-3 and ZW machines supplied by HCME will have a satellite communication unit installed as standard*, meaning each owner can directly enjoy the benefits of e-Service Owner's Site. Your local dealer will be able to give you access to e-Service Owner's Site.

- Optimizing fleet management
- Accurate maintenance planning
- Job planning support tool
- Swift trouble shooting

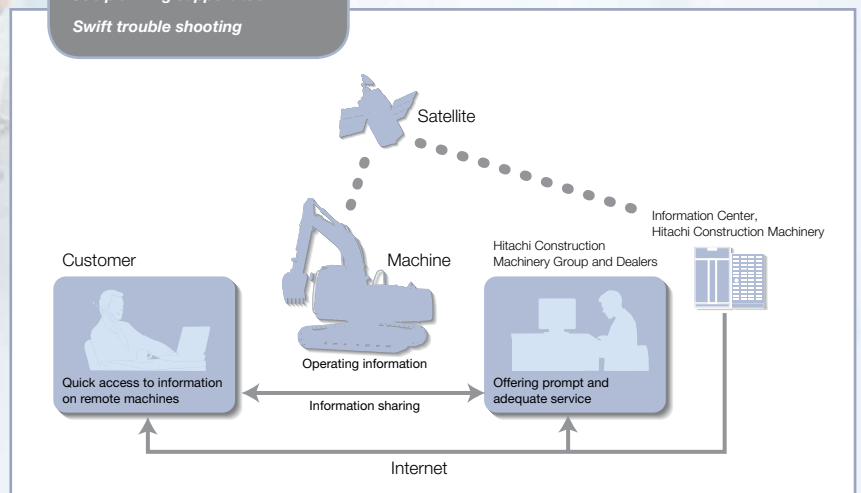

* (1) Satellite communication may be forbidden by the local regulatory standards (including safety standards) and legal requirements of the particular country where you wish to use it. Please contact HITACHI dealer for details.
 (2) Satellite communication basically allows for worldwide coverage. Please contact HITACHI dealer for the latest situation on actual satellite communication availability for your country or specific jobsite.
 (3) If transmission of the satellite signal is hindered in any way, satellite communication may not be possible.

SPECIFICATIONS

ENGINE

Model	Isuzu AJ-4JJ1X
Type	4-cycle water-cooled, direct injection
Aspiration	Turbocharged, intercooled
No. of cylinders	4
Rated power	
ISO 9249, net	69.0 kW (93.0 HP) at 2 000 min ⁻¹ (rpm)
EEC 80/1269, net ..	69.0 kW (93.0 HP) at 2 000 min ⁻¹ (rpm)
SAE J1349, net	69.0 kW (93.0 HP) at 2 000 min ⁻¹ (rpm)
Maximum torque	372 N·m (38 kgf·m) at 1 600 min ⁻¹ (rpm)
Piston displacement ..	2.999 L
Bore and stroke	95.4 mm x 104.9 mm
Batteries	2 x 12 V / 55 Ah

HYDRAULIC SYSTEM

- Work mode selector
Digging mode / Attachment mode
 - Engine speed sensing system
- | | |
|---------------------|--|
| Main pumps | 2 variable displacement axial piston pumps |
| Maximum oil flow .. | 2 x 117 L/min |
| Pilot pump | 1 gear pump |
| Maximum oil flow .. | 33.6 L/min |

Hydraulic Motors

Travel	2 variable displacement axial piston motors
Swing	1 axial piston motor

Relief Valve Settings

Implement circuit	34.3 MPa (350 kgf/cm ²)
Swing circuit	32.3 MPa (329 kgf/cm ²)
Travel circuit	34.3 MPa (350 kgf/cm ²)
Pilot circuit	3.9 MPa (40 kgf/cm ²)

Hydraulic Cylinders

High-strength piston rods and tubes. Cylinder cushion mechanisms provided in boom and arm cylinders to absorb shock at stroke ends.

Dimensions

	Quantity	Bore	Rod diameter
Boom	2	105 mm	70 mm
Arm	1	115 mm	80 mm
Bucket	1	100 mm	70 mm
Positioning	1	140 mm	95 mm

Hydraulic Filters

Hydraulic circuits use high-quality hydraulic filters. A suction filter is incorporated in the suction line, and full-flow filters in the return line and swing/travel motor drain lines.

CONTROLS

Pilot controls. Hitachi's original shockless valve.

Implement levers	2
Travel levers with pedals	2

UPPERSTRUCTURE

Revolving Frame

Welded sturdy box construction, using heavy-gauge steel plates for ruggedness. D-section frame for resistance to deformation.

Swing Device

Axial piston motor with planetary reduction gear is bathed in oil. Swing circle is single-row, shear-type ball bearing with induction-hardened internal gear. Internal gear and pinion gear are immersed in lubricant. Swing parking brake is spring-set/hydraulic-released disc type.

Swing speed	13.7 min ⁻¹ (rpm)
Swing torque	34.0 kN·m (3 470 kgf·m)

Operator's Cab

Independent spacious cab, 1 005 mm wide by 1 675 mm high, conforming to ISO* Standards. Reinforced glass windows on 4 sides for visibility. Front windows (upper and lower) can be opened. Reclining seat with armrests; adjustable with or without control levers.

* International Standardization Organization

UNDERCARRIAGE

Tracks

Tractor-type undercarriage. Welded track frame using selected materials. Side frame welded to track frame. Lubricated track rollers, idlers, and sprockets with floating seals.

Track shoes with triple grousers made of induction-hardened rolled alloy. Heat-treated connecting pins with dirt seals. Hydraulic (grease) track adjusters with shock-absorbing recoil springs.

Numbers of Rollers and Shoes on Each Side

Upper rollers	1 : ZX130-3
	2 : ZX130LCN-3
Lower rollers	7
Track shoes	44 : ZX130-3
	46 : ZX130LCN-3
Track guard	1

Travel Device

Each track driven by 2-speed axial piston motor through planetary reduction gear for counterrotation of the tracks. Sprockets are replaceable.

Parking brake is spring-set/hydraulic-released disc type. Travel shockless relief valve built in travel motor absorbs shocks when stopping travel.

Automatic transmission system: High-Low.

Travel speeds	High : 0 to 5.5 km/h
	Low : 0 to 3.4 km/h

Maximum traction force ..	95 kN (9 690 kgf)
---------------------------	-------------------

Gradeability	35° (70%) continuous
--------------------	----------------------

WEIGHTS AND GROUND PRESSURE

ZX130-3 with Monoblock Boom:

Equipped with 4.60 m monoblock boom, 2.52 m arm and 0.50 m³ (SAE, PCSA heaped) bucket.

Shoe type	Shoe width	Operating weight	Ground pressure
Triple grouser	500 mm	12 500 kg	39 kPa (0.40 kgf/cm ²)
	600 mm	12 700 kg	33 kPa (0.34 kgf/cm ²)
	700 mm	12 900 kg	28 kPa (0.29 kgf/cm ²)
	800 mm	13 200 kg	25 kPa (0.26 kgf/cm ²)
Pad	500 mm	12 400 kg	38 kPa (0.39 kgf/cm ²)

ZX130LCN-3 with Monoblock Boom:

Equipped with 4.60 m monoblock boom, 2.52 m arm and 0.50 m³ (SAE, PCSA heaped) bucket.

Shoe type	Shoe width	Operating weight	Ground pressure
Triple grouser	500 mm	12 700 kg	38 kPa (0.39 kgf/cm ²)
	600 mm	12 900 kg	32 kPa (0.33 kgf/cm ²)
	700 mm	13 100 kg	27 kPa (0.28 kgf/cm ²)
	800 mm	13 300 kg	25 kPa (0.25 kgf/cm ²)
Pad	500 mm	12 500 kg	37 kPa (0.38 kgf/cm ²)

ZX130-3 with Monoblock Boom with Blade (Optional):

Equipped with 4.60 m monoblock boom, 2.52 m arm and 0.50 m³ (SAE, PCSA heaped) bucket.

Shoe type	Shoe width	Operating weight	Ground pressure
Triple grouser	500 mm	13 600 kg	43 kPa (0.44 kgf/cm ²)

ZX130-3 with 2-Piece Boom:

Equipped with 2.10 m arm and 0.50 m³(SAE, PCSA heaped) bucket.

Shoe type	Shoe width	Operating weight	Ground pressure
Triple grouser	500 mm	12 900 kg	40 kPa (0.41 kgf/cm ²)
	600 mm	13 100 kg	34 kPa (0.35 kgf/cm ²)
	700 mm	13 300 kg	29 kPa (0.30 kgf/cm ²)
	800 mm	13 600 kg	26 kPa (0.27 kgf/cm ²)
Pad	500 mm	12 800 kg	40 kPa (0.41 kgf/cm ²)

ZX130LCN-3 with 2-Piece Boom:

Equipped with 2.10 m arm and 0.50 m³(SAE, PCSA heaped) bucket.

Shoe type	Shoe width	Operating weight	Ground pressure
Triple grouser	500 mm	13 100 kg	39 kPa (0.40 kgf/cm ²)
	600 mm	13 300 kg	33 kPa (0.34 kgf/cm ²)
	700 mm	13 500 kg	25 kPa (0.26 kgf/cm ²)
	800 mm	13 700 kg	25 kPa (0.26 kgf/cm ²)
Pad	500 mm	12 900 kg	38 kPa (0.39 kgf/cm ²)

ZX130-3 with 2-Piece Boom: with Blade (Optional):

Equipped with 2.10 m arm and 0.50 m³ (SAE, PCSA heaped) bucket.

Shoe type	Shoe width	Operating weight	Ground pressure
Triple grouser	500 mm	14 000 kg	44 kPa (0.45 kgf/cm ²)

Weights of the basic machines [including 2 700 kg counterweight and triple grouser shoes, excluding front-end attachment, fuel,hydraulic oil,engine oil and coolant etc.] are :

without Blade

ZX130-3 9 900 kg with 500 mm shoes
 ZX130LCN-3 10 000 kg with 500 mm shoes

with Blade

ZX130-3 10 900 kg with 500 mm shoes

SERVICE REFILL CAPACITIES

Fuel tank	250.0 L
Engine coolant	16.0 L
Engine oil	17.0 L
Swing device	3.2 L
Travel device	4.0 L
(each side)	
Hydraulic system	170.0 L
Hydraulic oil tank	70.0 L

SOUND LEVEL RESULTS (2000/14/EC)

LwA : sound-power level of airborne noise

LpA : sound level at operator's station

unit : dB(A)

	LwA	LpA
ZX130-3 / ZX130LCN-3	99	69

BACKHOE ATTACHMENTS

Boom and arms are of welded, box-section design. 4.60 m monoblock boom, 2-piece boom and 2.10 m, 2.52 m and 3.01 m arms are available.

BUCKETS

Capacity SAE, PCSA heaped	Width without side cutters	Weight
0.19 m ³	450 mm	260 kg
0.30 m ³	580 mm	313 kg
0.40 m ³	720 mm	361 kg
0.45 m ³	800 mm	390 kg
0.50 m ³	890 mm	414 kg
0.59 m ³	950 mm	430 kg
0.66 m ³	1 030 mm	429 kg

SPECIFICATIONS

DIMENSIONS : MONOBLOCK BOOM

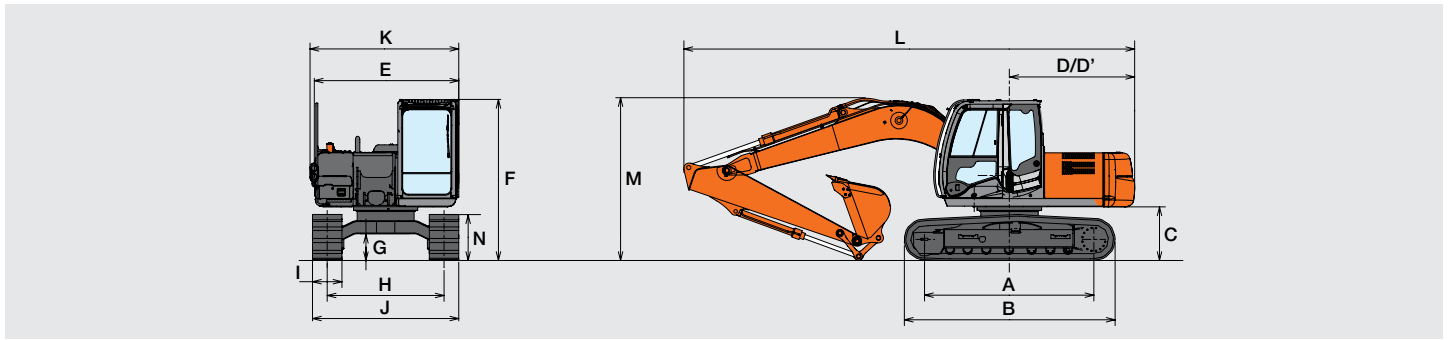

Unit: mm

	ZX130-3	ZX130LCN-3
A Distance between tumblers	2 880	3 050
B Undercarriage length	3 580	3 750
* C Counterweight clearance	890	890
D Rear-end swing radius	2 130	2 130
D' Rear-end length	2 130	2 130
E Overall width of upperstructure	2 460	2 460
F Overall height of cab	2 740	2 740
* G Min. ground clearance	440	440
H Track gauge	1 990	1 990
I Track shoe width	G 500	G 500
J Undercarriage width	2 490	2 490
K Overall width	2 490	2 490
L Overall length		
With 2.10 m arm	7 660	7 660
With 2.52 m arm	7 660	7 660
With 3.01 m arm	7 670	7 670
M Overall height of boom		
With 2.10 m arm	2 740	2 740
With 2.52 m arm	2 740	2 740
With 3.01 m arm	** 2 740	** 2 740
N Track height with triple grouser shoes	800	800

* Excluding track shoe lug ** The dimensions is shown in transportation of the arm. G: Triple grouser shoe

WORKING RANGES : MONOBLOCK BOOM

Unit: mm

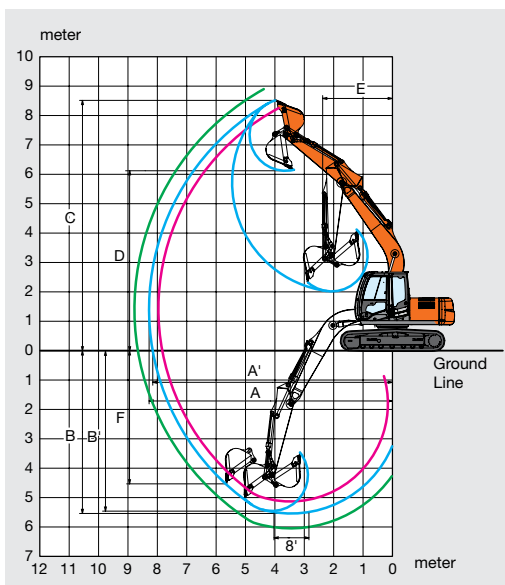

	ZX130-3 / ZX130LCN-3		
	4.60 m Monoblock boom		
Arm length	2.10 m	2.52 m	3.01 m
A Max. digging reach	7 960	8 320	8 790
A' Max. digging reach (on ground)	7 830	8 200	8 670
B Max. digging depth	5 150	5 570	6 060
B' Max. digging depth (8' level)	4 910	5 350	5 880
C Max. cutting height	8 370	8 570	8 900
D Max. dumping height	5 960	6 160	6 490
E Min. swing radius	2 370	2 390	2 640
F Max. vertical wall	4 270	4 550	5 020
Bucket digging force ISO	99 kN (10 100 kgf)		
Bucket digging force SAE : PCSA	86 kN (8 800 kgf)		
Arm crowd force ISO	73 kN (7 500 kgf)	65 kN (6 600 kgf)	58 kN (5 900 kgf)
Arm crowd force SAE : PCSA	71 kN (7 200 kgf)	63 kN (6 400 kgf)	57 kN (5 800 kgf)

Excluding track shoe lug

DIMENSIONS : 2-PIECE BOOM

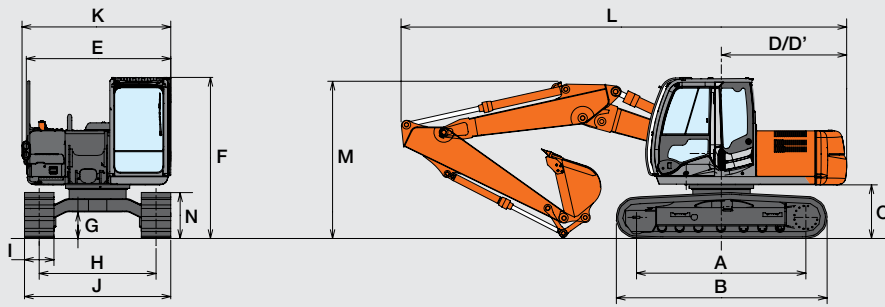

Unit: mm

	ZX130-3	ZX130LCN-3
A Distance between tumblers	2 880	3 050
B Undercarriage length	3 580	3 750
* C Counterweight clearance	890	890
D Rear-end swing radius	2 130	2 130
D' Rear-end length	2 130	2 130
E Overall width of upperstructure	2 460	2 460
F Overall height of cab	2 740	2 740
* G Min. ground clearance	440	440
H Track gauge	1 990	1 990
I Track shoe width	G 500	G 500
J Undercarriage width	2 490	2 490
K Overall width	2 490	2 490
L Overall length		
With 2.10 m arm	7 610	7 610
With 2.52 m arm	7 590	7 590
With 3.01 m arm	7 590	7 590
M Overall height of boom		
With 2.10 m arm	2 500	2 500
With 2.52 m arm	2 660	2 660
With 3.01 m arm	** 2 740	** 2 740
N Track height with triple grouser shoes	800	800

* Excluding track shoe lug

** The dimensions is shown in transportation of the arm.

G: Triple grouser shoe

WORKING RANGES : 2-PIECE BOOM

Unit: mm

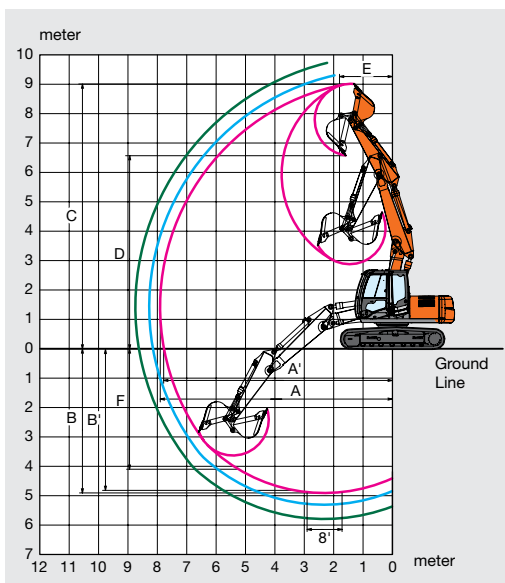

	ZX130-3 / ZX130LCN-3		
	2-Piece boom		
Arm length	2.10 m	2.52 m	3.01 m
A Max. digging reach	7 950	8 320	8 800
A' Max. digging reach (on ground)	7 820	8 200	8 680
B Max. digging depth	4 940	5 340	5 830
B' Max. digging depth (8' level)	4 810	5 220	5 720
C Max. cutting height	9 070	9 390	9 820
D Max. dumping height	6 610	6 930	7 360
E Min. swing radius	1 750	1 820	2 000
F Max. vertical wall	4 160	4 530	5 000
Bucket digging force ISO	99 kN (10 100 kgf)		
Bucket digging force SAE : PCSA	86 kN (8 800 kgf)		
Arm crowd force ISO	73 kN (7 500 kgf)	65 kN (6 600 kgf)	58 kN (5 900 kgf)
Arm crowd force SAE : PCSA	71 kN (7 200 kgf)	63 kN (6 400 kgf)	57 kN (5 800 kgf)

Excluding track shoe lug

SPECIFICATIONS

ZX130-3 with Blade (Optional)

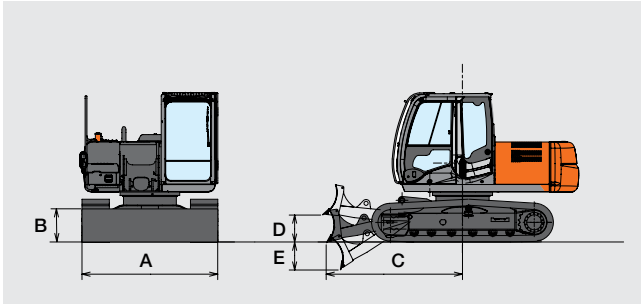

A Overall width of blade	2 490 mm
B Overall height of blade	610 mm
C Blade distance.....	2 480 mm
D Max. raising height above ground.....	480 mm
E Max. lowering depth from ground.....	500 mm

LIFTING CAPACITIES

Metric measure

- Notes: 1. Ratings are based on ISO 10567.
 2. Lifting capacity of the ZAXIS Series does not exceed 75% of tipping load with the machine on firm, level ground or 87% full hydraulic capacity.
 3. The load point is the centre-line of the bucket pivot mounting pin on the arm.
 4. *Indicates load limited by hydraulic capacity.
 5. 0 m = Ground.

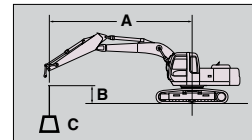

A: Load radius
 B: Load point height
 C: Lifting capacity

ZX130-3 Monoblock Boom

Rating over-front Rating over-side or 360 degrees Unit : kg

Conditions	Load Point Height	Load Radius										At max. reach			
		1.5 m		3.0 m		4.5 m		6.0 m		7.5 m		meter			
Arm 2.10 m	6.0 m														
Counterweight 2 700 kg	4.5 m					*3 730	3 500					*2 790	2 210	5.96	
Shoe 500 m	3.0 m			*6 340	6 180	*4 440	3 320	3 100	2 150			2 700	1 870	6.54	
	1.5 m					4 640	3 110	3 010	2 070			2 540	1 750	6.73	
	0 (Ground)			5 410	5 370	4 480	2 970	2 940	2 010			2 590	1 780	6.57	
	-1.5 m	*4 760	*4 760	*8 390	5 380	4 440	2 940	2 940	2 000			2 910	1 990	6.04	
	-3.0 m			*6 880	5 510	4 520	3 010					3 880	2 620	5.00	
	-4.5 m														

Conditions	Load Point Height	Load Radius										At max. reach			
		1.5 m		3.0 m		4.5 m		6.0 m		7.5 m		meter			
Arm 2.52 m	6.0 m														
Counterweight 2 700 kg	4.5 m					*3 350	*3 350	3 180	2 220			*2 310	2 000	6.37	
Shoe 500 m	3.0 m			*5 540	*5 540	*4 100	3 360	3 110	2 160			*2 300	1 720	6.91	
	1.5 m			*7 960	5 650	4 660	3 130	3 010	2 070			2 340	1 610	7.09	
	0 (Ground)			*6 330	5 350	4 480	2 970	2 930	1 990			2 380	1 630	6.94	
	-1.5 m	*4 560	*4 560	*8 680	5 320	4 400	2 900	2 890	1 960			2 630	1 790	6.44	
	-3.0 m	*8 410	*8 410	*7 460	5 410	4 440	2 940					3 340	2 260	5.48	
	-4.5 m														

Conditions	Load Point Height	Load Radius										At max. reach			
		1.5 m		3.0 m		4.5 m		6.0 m		7.5 m		meter			
Arm 3.01 m	6.0 m											*2 140	*2 140	5.97	
Counterweight 2 700 kg	4.5 m					*2 900	*2 900	2 950	2 250			*2 000	1 760	6.89	
Shoe 500 m	3.0 m			*4 570	*4 570	*3 660	3 410	3 130	2 170			*1 990	1 530	7.39	
	1.5 m			*7 250	5 790	*4 660	3 160	3 010	2 060	2 130	1 460	*2 080	1 440	7.56	
	0 (Ground)			*6 970	5 340	4 460	2 950	2 900	1 970			2 130	1 450	7.42	
	-1.5 m	*4 030	*4 030	*8 710	5 220	4 350	2 850	2 850	1 910			2 320	1 570	6.95	
	-3.0 m	*7 050	*7 050	*7 960	5 270	4 360	2 850	2 870	1 940			2 820	1 910	6.08	
	-4.5 m			*5 810	5 480	*3 620	3 000					*3 510	2 940	4.57	

LIFTING CAPACITIES

Metric measure

- Notes: 1. Ratings are based on ISO 10567.
 2. Lifting capacity of the ZAXIS Series does not exceed 75% of tipping load with the machine on firm, level ground or 87% full hydraulic capacity.
 3. The load point is the centre-line of the bucket pivot mounting pin on the arm.
 4. *Indicates load limited by hydraulic capacity.
 5. 0 m = Ground.

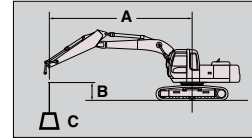

A: Load radius
 B: Load point height
 C: Lifting capacity

ZX130-3 Blade (Down) Monoblock Boom

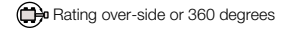
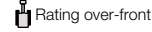

Unit : kg

Conditions	Load Point Height	Load Radius										At max. reach				
		1.5 m		3.0 m		4.5 m		6.0 m		7.5 m		meter				
Arm 2.10 m Counterweight 2 700 kg Shoe 500 m	6.0 m															
	4.5 m					*3 730	*3 730							*2 790	2 430	5.96
	3.0 m			*6 340	*6340	*4 440	3 630	*3 770	2 370					*2 750	2 070	6.54
	1.5 m					*5 300	3 420	*4 090	2 290					*2 890	1 940	6.73
	0 (Ground)			*5 410	*5410	*5 800	3 280	*4 280	2 220					*3 240	1 970	6.57
	-1.5 m	*4 760	*4 760	*8 390	5 930	*5 690	3 250	*4 010	2 220					*3 960	2 200	6.04
	-3.0 m			*6 880	6 060	*4 680	3 310							*3 940	2 890	5.00
	-4.5 m															

Conditions	Load Point Height	Load Radius										At max. reach				
		1.5 m		3.0 m		4.5 m		6.0 m		7.5 m		meter				
Arm 2.52 m Counterweight 2 700 kg Shoe 500 m	6.0 m															
	4.5 m					*3 350	*3 350	*3 310	2 440					*2 310	2 200	6.37
	3.0 m			*5 540	*5 540	*4 100	*3 670	*3 540	2 380					*2 300	1 900	6.91
	1.5 m			*7 960	6 200	*5 040	3 440	*3 920	2 290					*2 430	1 790	7.09
	0 (Ground)			*6 330	5 900	*5 680	3 280	*4 210	2 210					*2 710	1 810	6.94
	-1.5 m	*4 560	*4 560	*8 680	5 870	*5 750	3 210	*4 150	2 180					*3 290	1 990	6.44
	-3.0 m	*8 410	*8 410	*7 460	5 960	*5 070	3 250							*3 830	2 500	5.44
	-4.5 m															

Conditions	Load Point Height	Load Radius										At max. reach				
		1.5 m		3.0 m		4.5 m		6.0 m		7.5 m		meter				
Arm 3.01 m Counterweight 2 700 kg Shoe 500 m	6.0 m													*2 140	*2 140	5.97
	4.5 m					*2 900	*2 900	*2 950	2 470					*2 000	1 940	6.89
	3.0 m			*4 570	*4 570	*3 660	*3 660	*3 240	2 390					*1 990	1 700	7.39
	1.5 m			*7 250	6 330	*4 660	3 460	*3 690	2 280	*2 330	1 620			*2 080	1 600	7.56
	0 (Ground)			*6 970	5 890	*5 450	3 260	*4 060	2 180					*2 290	1 610	7.42
	-1.5 m	*4 030	*4 030	*8 710	5 770	*5 720	3 160	*4 170	2 130					*2 710	1 750	6.95
	-3.0 m	*7 050	*7 050	*7 960	5 820	*5 330	3 160	*3 660	2 150					*3 560	2 120	6.08
	-4.5 m			*5 810	*5 810	*3 620	3 310							*3 510	3 240	4.57

LIFTING CAPACITIES

Metric measure

- Notes: 1. Ratings are based on ISO 10567.
 2. Lifting capacity of the ZAXIS Series does not exceed 75% of tipping load with the machine on firm, level ground or 87% full hydraulic capacity.
 3. The load point is the centre-line of the bucket pivot mounting pin on the arm.
 4. *Indicates load limited by hydraulic capacity.
 5. 0 m = Ground.

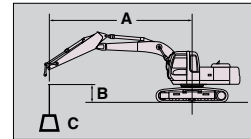

A: Load radius
 B: Load point height
 C: Lifting capacity

ZX130-3 2-Piece Boom

Rating over-front

Rating over-side or 360 degrees

Unit : kg

Conditions	Load Point Height	Load Radius										At max. reach		
		1.5 m		3.0 m		4.5 m		6.0 m		7.5 m				meter
2-Piece Boom Arm 2.10 m Counterweight 2 700 kg Shoe 500 m	7.5 m											*4 620	*4 620	2.59
	6.0 m			*4 810	*4 810	*4 230	3 580					*3 140	3 100	4.86
	4.5 m			*5 050	*5 050	*4 340	3 680					*2 800	2 200	6.00
	3.0 m	*10 750	*10 750	*7 800	6 500	*4 860	3 590	3 160	2 180			2 700	1 850	6.53
	1.5 m	*8 690	*8 690	*8 730	6 270	4 870	3 480	3 090	2 120			2 530	1 720	6.72
	0 (Ground)	*8 870	*8 870	*9 000	5 980	4 830	3 250	2 990	2 020			2 580	1 750	6.57
	-1.5 m	*13 320	*13 320	*9 140	5 680	4 600	3 040	2 940	1 980			2 920	1 970	6.03
	-3.0 m	*16 530	*16 530	*7 660	5 580	*3 690	3 000					*2 980	2 790	4.74
-4.5 m														











Conditions	Load Point Height	Load Radius										At max. reach		
		1.5 m		3.0 m		4.5 m		6.0 m		7.5 m				meter
2-Piece Boom Arm 2.52 m Counterweight 2 700 kg Shoe 500 m	7.5 m			*4 180	*4 180							*3 360	*3 360	3.46
	6.0 m			*3 870	*3 870	*3 870	3 670					*2 560	*2 560	5.36
	4.5 m			*3 900	*3 900	*4 090	3 670	3 210	2 250			*2 330	1 980	6.37
	3.0 m			*7 070	6 540	*4 560	3 610	3 210	2 240			*2 300	1 690	6.91
	1.5 m	*10 590	*10 590	*8 750	6 320	4 870	3 550	3 130	2 160			2 330	1 580	7.10
	0 (Ground)	*9 120	*9 120	*8 940	6 090	4 880	3 290	3 010	2 050			2 370	1 600	6.95
	-1.5 m	*11 930	*11 930	*9 030	5 700	4 630	3 070	2 920	1 960			2 630	1 770	6.44
	-3.0 m	*15 200	*15 200	*8 520	5 560	4 500	2 950					*2 530	2 280	5.42
-4.5 m														











Conditions	Load Point Height	Load Radius										At max. reach		
		1.5 m		3.0 m		4.5 m		6.0 m		7.5 m				meter
2-Piece Boom Arm 3.01 m Counterweight 2 700 kg Shoe 500 m	7.5 m											*2 680		4.37
	6.0 m					*3 330	*3 330					*2 180	*2 180	5.98
	4.5 m					*3 470	*3 470	*3 130	2 320			*2 010	1 740	6.90
	3.0 m			*4 480	*4 480	*4 230	3 620	3 220	2 310			*1 980	1 510	7.40
	1.5 m	*11 090	*11 090	*8 360	*6 320	4 860	3 480	3 150	2 220	2 130	1 440	*2 060	1 410	7.57
	0 (Ground)	*9 920	*9 920	*8 840	6 230	4 740	3 340	3 050	2 080			2 120	1 420	7.43
	-1.5 m	*10 990	*10 990	*8 890	5 720	4 680	3 110	2 910	1 950			2 310	1 540	6.96
	-3.0 m	*14 010	*14 010	*8 990	5 540	4 480	2 920	*2 590	1 920			*2 310	1 880	6.10
-4.5 m	*11 510	*11 510	*5 220	5 220							*4 390	*4 390	3.34	











ZX130-3 Blade (Down) 2-Piece Boom
 Rating over-front

 Rating over-side or 360 degrees

Unit : kg

Conditions	Load Point Height	Load Radius										At max. reach		
		1.5 m		3.0 m		4.5 m		6.0 m		7.5 m		meter		
														
2-Piece Boom Arm 2.10 m Counterweight 2 700 kg Shoe 500 m	7.5 m											*4 620	*4 620	2.59
	6.0 m			*4 810	*4 810	*4 230	3 880					*3 140	*3 140	4.86
	4.5 m			*5 050	*5 050	*4 340	3 950					*2 800	2 410	5.96
	3.0 m	*10 750	*10 750	*7 800	6 950	*4 860	3 860	*3 690	2 390			*2 740	2 040	6.54
	1.5 m	*8 690	*8 690	*8 730	6 760	*5 740	3 790	*3 970	2 330			*2 840	1 910	6.73
	0 (Ground)	*8 870	*8 870	*9 000	6 530	*5 790	3 560	*4 220	2 240			*3 150	1 940	6.57
	-1.5 m	*13 320	*13 320	*9 140	6 230	*5 820	3 350	*3 080	2 190			*2 990	2 180	6.03
	-3.0 m	*16 530	*16 530	*7 660	6 130	*3 690	3 310					*2 980	*2 980	4.74
-4.5 m														

Conditions	Load Point Height	Load Radius										At max. reach		
		1.5 m		3.0 m		4.5 m		6.0 m		7.5 m		meter		
														
2-Piece Boom Arm 2.52 m Counterweight 2 700 kg Shoe 500 m	7.5 m			*4 180	*4 180							*3 360	*3 360	3.46
	6.0 m			*3 870	*3 870	*3 870	*3 870					*2 560	*2 560	5.36
	4.5 m			*3 900	*3 900	*4 090	3 970					*2 330	2 180	6.37
	3.0 m			*7 070	7 000	*4 560	3 890	*3 270	2 460			*2 300	1 880	6.91
	1.5 m	*10 590	*10 590	*8 750	6 790	*5 420	*3 770	*3 490	2 460			*2 390	1 760	7.09
	0 (Ground)	*9 120	*9 120	*8 940	6 640	*5 750	3 600	*3 790	2 380			*2 640	1 780	6.95
	-1.5 m	*11 930	*11 930	*9 030	6 240	*5 810	3 380	*4 170	2 260			*2 950	1 960	6.44
	-3.0 m	*15 200	*15 200	*8 520	6 110	*4 760	3 260	*3 850	2 170			*2 530	2 520	5.42
-4.5 m														

Conditions	Load Point Height	Load Radius										At max. reach		
		1.5 m		3.0 m		4.5 m		6.0 m		7.5 m		meter		
														
2-Piece Boom Arm 3.01 m Counterweight 2 700 kg Shoe 500 m	7.5 m											*2 680	*2 680	4.37
	6.0 m					*3 330	*3 330					*2 180	*2 180	5.98
	4.5 m					*3 470	*3 470	*3 130	2 530			*2 010	1 920	6.90
	3.0 m			*4 480	*4 480	*4 230	3 890	*3 270	2 520			*1 980	1 670	7.40
	1.5 m	*11 090	*11 090	*8 360	6 760	*5 060	3 750	*3 570	2 430	*2 360	1 600	*2 060	1 570	7.57
	0 (Ground)	*9 920	*9 920	*8 840	6 570	*5 690	3 650	*3 960	2 300			*2 240	1 580	7.43
	-1.5 m	*10 990	*10 990	*8 890	6 270	*5 700	3 420	*4 120	2 170			*2 610	1 720	6.96
	-3.0 m	*14 010	*14 010	*8 990	6 090	*5 440	3 230	*2 590	2 130			*2 310	2 100	6.09
-4.5 m	*11 510	*11 510	*5 220	*5 220							4 390	*4 390	3.34	

LIFTING CAPACITIES

Metric measure

- Notes: 1. Ratings are based on ISO 10567.
 2. Lifting capacity of the ZAXIS Series does not exceed 75% of tipping load with the machine on firm, level ground or 87% full hydraulic capacity.
 3. The load point is the centre-line of the bucket pivot mounting pin on the arm.
 4. *Indicates load limited by hydraulic capacity.
 5. 0 m = Ground.

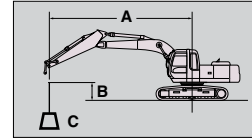

A: Load radius
 B: Load point height
 C: Lifting capacity

ZX130LCN-3 Monoblock Boom

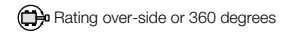
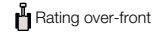

Unit : kg

Conditions	Load Point Height	Load Radius										At max. reach				
		1.5 m		3.0 m		4.5 m		6.0 m		7.5 m		meter				
Arm 2.10 m Counterweight 2 700 kg Shoe 500 m	6.0 m															
	4.5 m					*3 730	3 580					*2 790	2 270	5.96		
	3.0 m			*6 340	6 330	*4 440	3 410	3 420	2 210			*2 750	1 930	6.54		
	1.5 m					5 170	3 200	3 340	2 130			2 810	1 800	6.73		
	0 (Ground)			*5 410	*5 410	5 010	3 060	3 270	2 070			2 870	1 830	6.57		
	-1.5 m	*4 760	*4 760	*8 390	5 530	4 970	3 020	3 260	2 060			3 240	2 050	6.04		
	-3.0 m			*6 880	5 660	*4 680	3 090					*3 940	2 690	5.00		
-4.5 m																











Conditions	Load Point Height	Load Radius										At max. reach				
		1.5 m		3.0 m		4.5 m		6.0 m		7.5 m		meter				
Arm 2.52 m Counterweight 2 700 kg Shoe 500 m	6.0 m															
	4.5 m					*3 350	*3 350	*3 310	2 290			*2 310	2 070	6.37		
	3.0 m			*5 540	*5 540	*4 100	3 460	3 440	2 230			*2 300	1 780	6.91		
	1.5 m			*7 960	5 830	*5 040	3 230	3 340	2 140			*2 430	1 670	7.09		
	0 (Ground)			*6 330	5 530	5 010	3 070	3 250	2 060			2 630	1 680	6.94		
	-1.5 m	*4 560	*4 560	*8 680	5 500	4 930	3 000	3 220	2 030			2 920	1 860	6.44		
	-3.0 m	*8 410	*8 410	*7 460	5 590	4 980	3 040					3 720	2 340	5.48		
-4.5 m																











Conditions	Load Point Height	Load Radius										At max. reach				
		1.5 m		3.0 m		4.5 m		6.0 m		7.5 m		meter				
Arm 3.01 m Counterweight 2 700 kg Shoe 500 m	6.0 m											*2 140	*2 140	5.97		
	4.5 m					*2 900	*2 900	*2 950	2 310			*2 000	1 810	6.89		
	3.0 m			*4 570	*4 570	*3 660	3 490	*3 240	2 230			*1 990	1 580	7.39		
	1.5 m			*7 250	5 930	*4 660	3 240	3 340	2 120	*2 330	1 500	*2 080	1 480	7.56		
	0 (Ground)			*6 970	5 490	5 000	3 030	3 230	2 020			*2 290	1 490	7.42		
	-1.5 m	*4 030	*4 030	*8 710	5 370	4 880	2 930	3 170	1 970			2 580	1 620	6.95		
	-3.0 m	*7 050	*7 050	*7 960	5 420	4 890	2 940	3 200	2 000			3 140	1 960	6.08		
-4.5 m			*5 810	5 630	*3 620	3 080					*3 510	3 020	4.57			











ZX130LCN-3 2-Piece Boom
 Rating over-front

 Rating over-side or 360 degrees

Unit : kg

Conditions	Load Point Height	Load Radius										At max. reach			
		1.5 m		3.0 m		4.5 m		6.0 m		7.5 m		meter			
															
Arm 2.10 m Counterweight 2 700 kg Shoe 500 m	7.5 m												*4 620	*4 620	2.59
	6.0 m			*4 810	*4 810	*4 230	3 680						*3 140	*3 140	4.86
	4.5 m			*5 050	*5 050	*4 340	3 370						*2 800	2 270	5.96
	3.0 m	*10 750	*10 750	*7 800	6 650	*4 860	3 680	3 490	2 250				*2 740	1 910	6.54
	1.5 m	*8 690	*8 690	*8 730	6 440	5 340	3 590	3 420	2 190				2 810	1 780	6.73
	0 (Ground)	*8 870	*8 870	*9 000	6 160	*5 380	3 350	3 320	2 090				2 870	1 810	6.57
	-1.5 m	*13 320	*13 320	*9 140	5 860	5 140	3 140	*3 080	2 050				*2 990	2 040	6.03
	-3.0 m	*16 530	*16 530	*7 660	5 760	*3 690	3 100						*2 980	2 880	4.74
-4.5 m															

Conditions	Load Point Height	Load Radius										At max. reach			
		1.5 m		3.0 m		4.5 m		6.0 m		7.5 m		meter			
															
Arm 2.52 m Counterweight 2 700 kg Shoe 500 m	7.5 m			*4 180	*4 180								*3 360	*3 360	3.46
	6.0 m			*3 870	*3 870	*3 870	3 760						*2 560	*2 560	5.36
	4.5 m			*3 900	*3 900	*4 090	3 780	*3 270	2 320				*2 330	2 050	6.37
	3.0 m			*7 070	6 700	*4 560	3 700	*3 490	2 310				*2 300	1 750	6.91
	1.5 m	*10 590	*10 590	*8 750	6 470	5 320	3 650	3 450	2 230				*2 390	1 640	7.09
	0 (Ground)	*9 120	*9 120	*8 940	6 270	5 250	3 390	3 340	2 120				2 630	1 660	6.95
	-1.5 m	*11 930	*11 930	*9 030	5 880	5 180	3 170	3 250	2 030				2 920	1 830	6.44
	-3.0 m	*15 200	*15 200	*8 520	5 740	*4 760	3 050						*2 530	2 360	5.42
-4.5 m															

Conditions	Load Point Height	Load Radius										At max. reach			
		1.5 m		3.0 m		4.5 m		6.0 m		7.5 m		meter			
															
Arm 3.01 m Counterweight 2 700 kg Shoe 500 m	7.5 m												*2 670	*2 670	4.38
	6.0 m					*3 320	*3 320						*2 180	*2 180	5.98
	4.5 m					*3 470	*3 470	*3 130	2 390				*2 010	1 800	6.90
	3.0 m			*4 470	*4 470	*4 230	3 710	*3 270	2 380				*1 980	1 560	7.40
	1.5 m	*11 090	*11 090	*8 360	*6 470	*5 060	3 570	3 440	2 290	2 360	1 490		*2 050	1 460	7.57
	0 (Ground)	*9 930	*9 930	*8 840	6 410	5 220	3 440	3 370	2 150				*2 240	1 470	7.43
	-1.5 m	*10 990	*10 990	*8 890	5 900	5 230	3 210	3 250	2 020				2 580	1 600	6.96
	-3.0 m	*14 010	*14 010	*8 990	5 720	5 020	3 030	*2 590	1 990				*2 310	1 950	6.09
-4.5 m	*11 510	*11 510	*5 220	*5 220								*4 390	*4 390	3.34	

STANDARD EQUIPMENT

Standard equipment may vary by country, so please consult your Hitachi dealer for details.

ENGINE

- H/P mode control
- E mode control
- 50 A alternator
- Dry-type air filter with evacuator valve (with air filter restriction indicator)
- Cartridge-type engine oil filter
- Cartridge-type fuel double filters
- Air cleaner double filters
- Radiator, oil cooler and intercooler with dust protective net
- Radiator reserve tank
- Fan guard
- Isolation-mounted engine
- Auto idle system
- Fuel cooler
- Electrical fuel feed pump
- Engine oil drain coupler

HYDRAULIC SYSTEM

- Work mode selector
- Control valve with main relief valve
- Extra port for control valve
- Suction filter
- Full-flow filter
- Pilot filter

CAB

- CRES II (Center pillar reinforced structure) cab
- OPG top guard fitted Level I (ISO10262) compliant cab
- All-weather sound suppressed steel cab
- Equipped with reinforced, tinted (green color) glass windows
- 4 fluid-filled elastic mounts
- Front windows on upper, lower and left side can be opened
- Intermittent windshield wipers
- Front window washer
- Adjustable reclining seat with adjustable armrests
- Footrest
- Electric double horn
- AM-FM radio with digital clock
- Seat belt
- Drink holder
- Cigarette lighter
- Ashtray
- Storage box
- Glove compartment
- Fire extinguisher bracket
- Floor mat
- Short wrist control levers
- Pilot control shut-off lever
- Engine shut-off switch
- Auto control air conditioner
- Transparent roof with slide curtain
- Mechanical suspension seat with heater

MONITOR SYSTEM

- Display of meters: water temperature, hour, fuel rate, clock
- Other displays: work mode, auto-idle, glow, rearview monitor, operating conditions, etc
- Alarms: overheat, engine warning, engine oil pressure, alternator, minimum fuel level, hydraulic filter restriction, air filter restriction, work mode, overload, etc
- Alarm buzzers: overheat, engine oil pressure, overload

LIGHTS

- 2 working lights

UPPER STRUCTURE

- Undercover
- 2 700 kg counterweight
- Fuel level float
- Electric fuel refilling pump with auto stop
- Rear view camera
- 55 Ah batteries
- Hydraulic oil level gauge
- Tool box
- Rear view mirror (right & left side)
- Swing parking brake

UNDERCARRIAGE

- Travel parking brake
- Travel motor covers
- Hydraulic track adjuster
- Bolt-on sprocket
- Upper and lower rollers
- Reinforced track links with pin seals
- 4 tie down hooks
- Track guard (each side)

FRONT ATTACHMENTS

- HN bushing
- WC (tungsten-carbide) thermal spraying
- Reinforced resin thrust plate
- Flanged pin
- Centralized lubrication system
- Dirt seal on all bucket pins

MISCELLANEOUS

- Standard tool kit
- Lockable machine covers
- Lockable fuel refilling cap
- Skid-resistant tapes, plates and handrails
- Travel direction mark on track frame
- Onboard information controller

OPTIONAL EQUIPMENT

Optional equipment may vary by country, so please consult your Hitachi dealer for details.

CAB

- Laminated round glass window
- OPG top guard, Level II
- Air suspension seat with heater
- Rain guard
- Sun visor
- 12 V power source

LIGHTS

- Additional cab roof front lights
- Additional cab roof rear lights
- Rotating lamp
- Additional boom light with cover

UNDERCARRIAGE

- Track undercover

ATTACHMENTS

- Hammer and crusher piping
- Parts for hammer and crusher
- 2 pump combined flow
- Additional pump (30 L/min)
- Pilot accumulator
- High mesh full flow filter with restriction indicator
- Welded bucket link A with welded hook

OTHERS

- Hose rupture valve
- Overload warning device
- Pre-cleaner
- Biodegradable oil

Prior to operating this machine, including satellite communication system, in a country other than a country of its intended use, it may be necessary to make modifications to it so that it complies with the local regulatory standards (including safety standards) and legal requirements of that particular country. Please do not export or operate this machine outside the country of its intended use until such compliance has been confirmed. Please contact your Hitachi dealer in case of questions about compliance.

These specifications are subject to change without notice.

Illustrations and photos show the standard models, and may or may not include optional equipment, accessories, and all standard equipment with some differences in colour and features. Before use, read and understand the Operator's Manual for proper operation.