

M318C

Wheel Excavator

The CAT logo, consisting of the letters 'CAT' in a bold, white, sans-serif font, with a yellow triangle pointing upwards from the letter 'A'. The logo is set against a black background.

Cat® 3056E ATAAC diesel engine

Gross power	119 kW/159 hp
Net power	113 kW/151 hp
Operating Weight	17 800 to 19 700 kg
Bucket Capacities	0.35 to 1.09 m ³
Maximum Reach at Ground Level	9600 mm
Maximum Digging Depth	6360 mm
Travel Speed	34 km/h

M318C Wheel Excavator

The C Series incorporates innovations for improved performance and versatility.

Engine

- ✓ The new Cat 3056E ATAAC electronically controlled engine provides increased horsepower to serve the advanced hydraulic system. Performance, reliability, durability, excellent fuel economy, and low sound levels help maximize working efficiency. The innovative cooling system is easy to clean and features increased cooling capacity through a temperature sensing on-demand fan. **pg. 4**

Hydraulics

The hydraulic system, featuring a separate swing pump and load-sensing system, provides maximum power and exceptional controllability leading to high performance in all applications. The technologically advanced Tool Control option adds work tool flexibility to the hydraulic system. Using the monitor panel in the cab, the operator can quickly select pre-programmed hydraulic settings to optimize performance of up to five different work tools. **pg. 5**

A Step Ahead in Environmental Considerations

Helping to protect our environment, the engine has low operator and spectator sound levels. In addition the hydraulic system can be operated with biodegradable oil. Longer filter change intervals and more fuel efficiency also help reduce impact on our environment. **pg. 6**

Ease of Operation

- ✓ On the new WEX Multipro monitor panel, a variety of easy-to-read, language-based data is displayed. At all times, the operator can check the machine status allowing for continuous production optimization. **pg. 7**



Increased lifting capacity, improved cycle times, and ease of operation lead to increased productivity and cost effective solutions.

- ✓ *New features*

Operator Comfort

- ✓ The new operator station design maximizes operator comfort and visibility. A new comfort seat with air suspension (optional), ergonomic joysticks, a new soft switch panel and the WEX Multipro monitor are some of the features that help allow the operator to work free of fatigue and so remain attentive to the job in hand. The operator station also offers more space to the side and the front and features automatic climate control. **pg. 8**

Undercarriage

Pin-On design of outriggers and dozer blade allows for interchangeability and helps maximize flexibility to match the application requirements. Heavy-duty cylinder protection and box section design help provide excellent durability. A sealed and lockable toolbox is mounted between the steps. **pg. 10**

Booms and Sticks

The box section design of all front-end structures, together with the optimum balance of durability and weight provide the strength needed for even the toughest application. Multiple boom and stick options allow you to pick the best match for your job. **pg. 11**

Buckets and Teeth

- ✓ A wide variety of bucket types are available for the M300 C-Series. These aggressive bucket designs are matched to fit the high C-Series digging forces to improve productivity. **pg. 12**

Work Tools

- ✓ Buckets, grapples, hammers, and quick couplers provide a total solution package to the end-user. Built for performance and durability these tools deliver high productivity, long service life and excellent value. **pg. 13**

Maintenance and Reliability

All daily maintenance points, such as oil level or greasing ports, are accessible from ground level. A centralized greasing port located in the engine compartment provides protection, and allows the operator to grease the front linkage and swing bearing without climbing onto the machine. **pg. 14**

Complete Customer Service

Your Cat dealer offers a wide range of services that can be set up under a customer support agreement when you purchase your equipment. The dealer will help you choose a plan that can cover everything from machine and attachment selection to replacement. **pg. 17**



Cat 3056E ATAAC Engine

The six-cylinder, turbocharged, air-to-air aftercooled and electronically controlled engine is built for power, reliability, low maintenance, excellent fuel economy and low emissions.

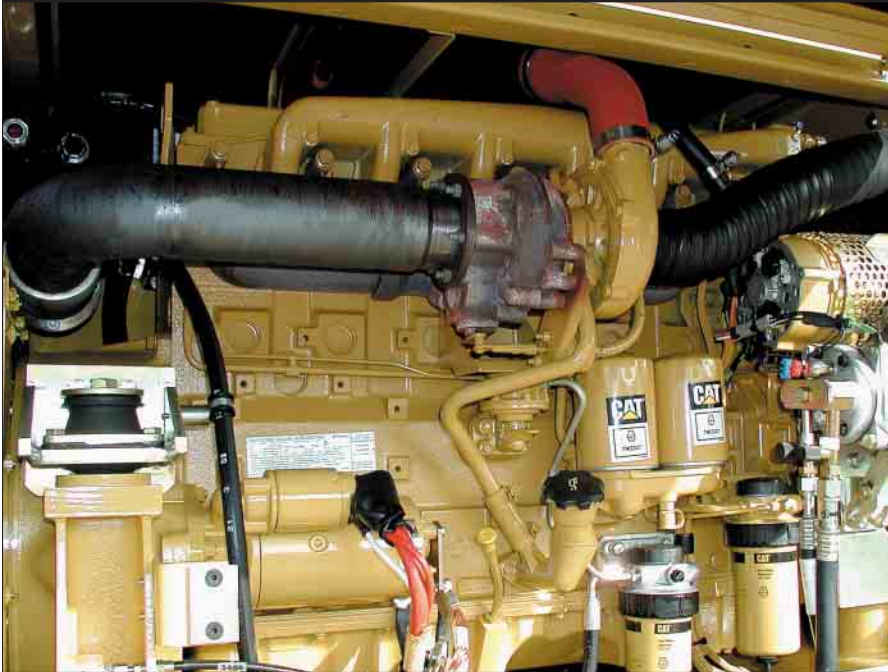

Powerful Performance. The 3056E ATAAC engine delivers a net power of 113 kW (151 hp) at the rated speed of 2000 rpm, and meets all current worldwide emission standards.

Turbocharged and Air-to-Air Aftercooled. The turbocharger packs more dense air into the cylinders for more complete combustion and lower emission improving performance and engine efficiency. These benefits are especially useful at high altitudes. The air-to-air aftercooler reduces smoke and emissions by providing a cooler inlet air for more efficient combustion. This also extends the life of the piston rings and engine bore.

Cooling System. Features an electronically controlled variable speed on-demand fan. The fan is driven by a hydraulic motor and its speed is determined by engine coolant and hydraulic oil. Cooler operating conditions allow lower average fan speeds resulting in reduced fuel consumption and lower noise levels. The electronic engine control continuously compensates for this varying fan load, providing consistent net horsepower, regardless of operating conditions. The fan and air conditioner condenser are both hinged for easier cleaning of the cores.

Engine Oil. Caterpillar engine oil is formulated to optimize engine life and performance and is strongly recommended for use in Cat diesel engines. The engine oil change interval is increased to 500 hours.

Low Sound, Low Vibration. The 3056E design improves operator comfort by reducing sound and vibration. The M318C has been awarded the German Blue Angel for low operator and spectator sound levels.

- Operator sound level, L_{PA} , 72 db(A)
- Spectator sound level, L_{WA} 102 db(A)

Factory Remanufactured Parts. A large choice of factory remanufactured parts and dealer proposed repair options increase machine availability and reduce total repair costs.

Bosch Fuel Injection Pump. The new Bosch injection pump is electronically controlled and helps to reduce fuel consumption.

Service. The engine is longitudinally mounted on the right side to make it easier to access the oil filter, oil filler, oil drain valve, fuel filter, V-belt tightener, and the oil dipstick. All are accessible from ground level.

Hydraulics

Fast cycle times, increased lift capacity, and high bucket and stick forces combine to maximize your productivity in any job.

Automatic Engine Control.

Automatic Engine Control (AEC) reduces engine rpm if no operation is performed, maximizing fuel efficiency and reducing sound levels.

A Dedicated Swing Pump. A separate dedicated variable displacement piston pump and fixed displacement piston motor power the swing mechanism. This closed hydraulic circuit helps to provide maximum swing performance without reducing power to the main hydraulic functions.

Caterpillar's XT-6 ES Hoses.

To meet the critical flexibility and strength demands of wheel excavator applications, XT-6 ES hoses are installed in the high pressure hydraulic system. XT-6 ES hoses are made of four overlapping insulated wire spiral wraps bonded together for high abrasion resistance, excellent flexibility and easy installation. Hose routings are designed to protect from damage in this way reducing hose failure downtime. O-ring face seal couplings provide positive sealing for reliable and leak-free connections.

Auxiliary Hydraulic Valves.

The versatility of the hydraulic system can be expanded with multiple valve options.

Multifunction Valve. The multifunction valve is the core of the innovative Tool Control system. This valve can be electronically programmed for flow direction (one or two ways), pressure and flow rate. The valve also features priority flow to maximize control of the work tool. This on-board electro-hydraulic functionality eliminates the need for manual readjustments to the auxiliary hydraulics each time a different tool is used.

Hammer. The dedicated hammer valve is the best option for machines which will only require a hammer tool and do not need the flexibility provided by the multifunction valve.

Medium Pressure. A medium pressure valve is available for use with standard medium pressure tools.

Hydraulic Cylinder Snubbers.

The hydraulic cylinder snubbers at the rod end of boom cylinders, both ends of stick cylinders, and bucket cylinder rod end cushion shocks reduce sound and increase cylinder life, keeping the machine working longer.

Caterpillar® Hydraulic Oil.

Maximum protection against mechanical and corrosive wear in all hydraulic systems. Its high zinc content reduces wear, and extends pump life. Provided certain requirements are met (e.g. S•O•Ssm analysis every 500 hours), the hydraulic oil change interval is extended from 2000 hours to 4000 hours.

Controllability. The hydraulic system offers precise control of the M318C, reducing operator fatigue, improving operator effectiveness and efficiency, which ultimately results in enhanced performance.

Stick Regeneration Circuit.

Stick regeneration circuits increase efficiency and help increase controllability for higher productivity and lower operating costs.



Environmentally Responsible Design

Caterpillar machines not only help you build a better world, they help maintain and preserve the fragile environment.



More Performance. The M318C is designed to provide more performance yet uses less fuel than ever before. This means more work done in a day, less fuel consumed and minimal impact on our environment.

Low Exhaust Emissions. The Cat 3056E used in the M318C is a low emission engine designed to meet EU Stage II Off-Highway and US EPA Tier II emission regulations.

Quiet Operation. Not only is the cab quiet, but spectators outside hear less noise too. As a result of the new variable speed fan and remote cooling system all machines meet the German Blue Angel award for low sound operation.

Ozone Protection. To help protect the earth's ozone layer, the M318C's air conditioning unit uses only R-134a refrigerant which does not contain harmful chlorofluorocarbons (CFC's).

Biodegradable Hydraulic Oil. Available as an option, Caterpillar Biodegradable Hydraulic Oil (HEES™) is formulated from a fully saturated Hydraulic Environmental with Ester Synthetic base stock and selected additives. It has excellent high-pressure and high-temperature characteristics and is fully compatible with our hydraulic components and allows operation over a broad temperature range. Cat's HEES is fully decomposed by soil or water microorganisms, providing a more environmentally-sound alternative to mineral-based oils. This is available as an attachment.

Fewer Leaks and Spills. Lubricant fillers and drains are designed to minimize spills. Cat O-Ring Face Seals, XT Hose and hydraulic cylinders are all designed to help prevent fluid leaks that can reduce the machine performance and cause harm to the environment.

Longer Service Intervals. 500-hour engine service intervals and Cat Extended Life Coolant/Antifreeze mean that fluid renewal and disposal are less frequent.

Rebuildable Components. Many of the major components used in the M318C are designed for remanufacturing. This means you have high-quality, certified rebuilt replacement parts available at a fraction of the cost of new parts. There is less scrap for disposal.

Ease of Operation

Designed for simple, easy operation, the M318C allows the operator to focus on production.



WEX Multipro. New, compact Multipro enhances viewing while displaying a variety of easy-to-read and understandable information in various languages.

Pre-start WEX Multipro System.

The Pre-start Multipro system alerts the operator of low coolant, engine oil or hydraulic oil levels, before starting the engine. When the engine key remains in the “ON” position for more than 2 seconds, a warning indicator and message are displayed if actual fluid levels are lower than required.

Filter and Oil Change Warnings.

The filter and oil change warnings are displayed when the number of hours used reaches the maintenance interval.

Power Modes. There are three power mode settings. The operator can choose the best power setting for both engine and hydraulic power versus fuel efficiency.

Economy Mode. The economy mode is often used for lifting, pipe setting, grading, slope finishing and precise work. This mode helps ensure minimum fuel consumption.

Power Mode. This mode is used for normal truck loading and digging applications, trenching or hammer use.

Travel Mode. The travel mode is automatically set when the travel pedal is actuated. It provides maximum speed and drawbar pull.

Integrated Tool Control System.

The integrated Tool Control system allows the operator to quickly select a tool out of five pre-set combinations, eliminating the need to re-set these hydraulic parameters each time a tool is changed. Specific flow and pressure can be programmed easily as well as one-way/two-way hydraulic functions. Each of the five programmed tools can even be given a specific name.

Languages. 14 different languages are available on the M318C.

All-day operator comfort

The M318C interior layout maximizes operator space, provides exceptional comfort, and reduces operator fatigue.





Interior Operator Station. The M318C operator work station is quiet, controls have been placed conveniently for easy adjustment and ease of operation. The seat design is ergonomic and ventilation is highly effective.

Seat. The new wheel excavator seat with two-tone color design offers adjustable back rest, lumbar support, cushion length and cushion angle. Independently adjustable armrests and pilot controls allow tailored ergonomics to suit operator preference. Optional Comfort seat provides air suspension, seat heating, horizontal suspension and automatic adjustment for the operator's weight to help maximize comfort.

Consoles. Designed for simplicity and functionality, the left side console is tiltable for excellent access to the cab. Dozer blade and/or outrigger controls as well as the radio-off switch are located on the left console.

Automatic Climate Control. Fully automatic climate control adjusts temperature and air flow.

Greater Control Convenience. Each of the controls is positioned within easy reach of the operator. Joysticks control all implements and swing functions. Via the soft switch panel, the operator controls the oscillating axle, power modes, parking brake, automatic engine speed control, and other hydraulic functions are in an easy-to-read environment.

Cab Mounts. The cab shell is attached to the frame with resilient mounts, reducing vibration and sound.



Skylight. A unique large polycarbonate skylight provides excellent upward visibility.

Viewing Area. There is excellent viewing area through wide windows. The lower of the two-piece window can be opened separately for better air ventilation or be slid into the upper window to completely open the front bay. An optional one-piece window is available.

Wipers. Designed to maximize visibility in poor weather conditions. The parallel wiper system covers almost the complete front window without leaving unwiped areas in the immediate line of sight of the operator.

Large Storage Compartment. Located behind the seat, provides sufficient room for a cooling box. An optional cover is available to close off the storage space if preferred.

Easy Access. Conveniently located grab irons and large steps mounted to the undercarriage, together with the tiltable steering column and the tiltable left side console, provide easy access to the cab.

Undercarriage

Undercarriage and axle design provides maximum strength, flexibility and mobility on wheels.



A Strong Undercarriage. The welded frame provides excellent rigidity and long life. Efficient hydraulic lines routing, transmission protection and heavy-duty axles make the undercarriage perfect for wheel excavator applications. Both outriggers and dozer blade are pin-on for maximum flexibility.

Heavy Duty Axles. The front axles offer great oscillating and steering angles. The transmission is mounted directly on the rear axle for protection and optimum ground clearance.

Outriggers. Recommended for maximum operating stability when digging and lifting, the outriggers can be individually controlled to level the machine on slopes. Featuring pin-on design, heavy-duty cylinder guards, and optimized kinematics, the outriggers can be mounted on the front, rear or on both ends of the machine.

Dozer Blade. A useful addition for leveling and clean-up work, it can also be used to stabilize the machine during digging applications. The large dozer floor and the parallel design provide minimal ground pressure reducing impact to the work surface. Featuring a pin-on design, heavy-duty cylinder guards, and optimized kinematics, the dozer blade can be mounted either on the front or the rear end.

Tool Box. A large sealed and lockable toolbox is mounted on the undercarriage between the steps on the machines left side. A second optional toolbox is available for the right side.



Booms and Sticks

Improved strength and kinematics help bring higher production and efficiency to all jobs.

Booms and Sticks. Built for performance and long service life, Caterpillar booms and sticks are large, welded, box-section structures with thick, multi-plate fabrications in high-stress areas.

Flexibility. The choice of two booms and three different sticks means that the M318C offers the right combination of reach and digging forces for all applications.

One-piece Boom. The one-piece boom (5400 mm) fits best for all standard applications such as truck loading and digging. A unique straight section in the curve of the side plate reduces stress flow and helps increase boom life.

Hydraulically Adjustable Boom (VA). The VA boom (5260 mm) offers improved visibility and machine roading balance. When working in tight quarters or lifting heavy loads, the VA boom offers the best flexibility.

Sticks. Three different stick lengths are offered to match different applications.

- **Short stick** (2200 mm) for maximum breakout force and lifting capability
- **Medium stick** (2500 mm) as standard for most applications
- **Long stick** (2800 mm) to match reach and depth requirements

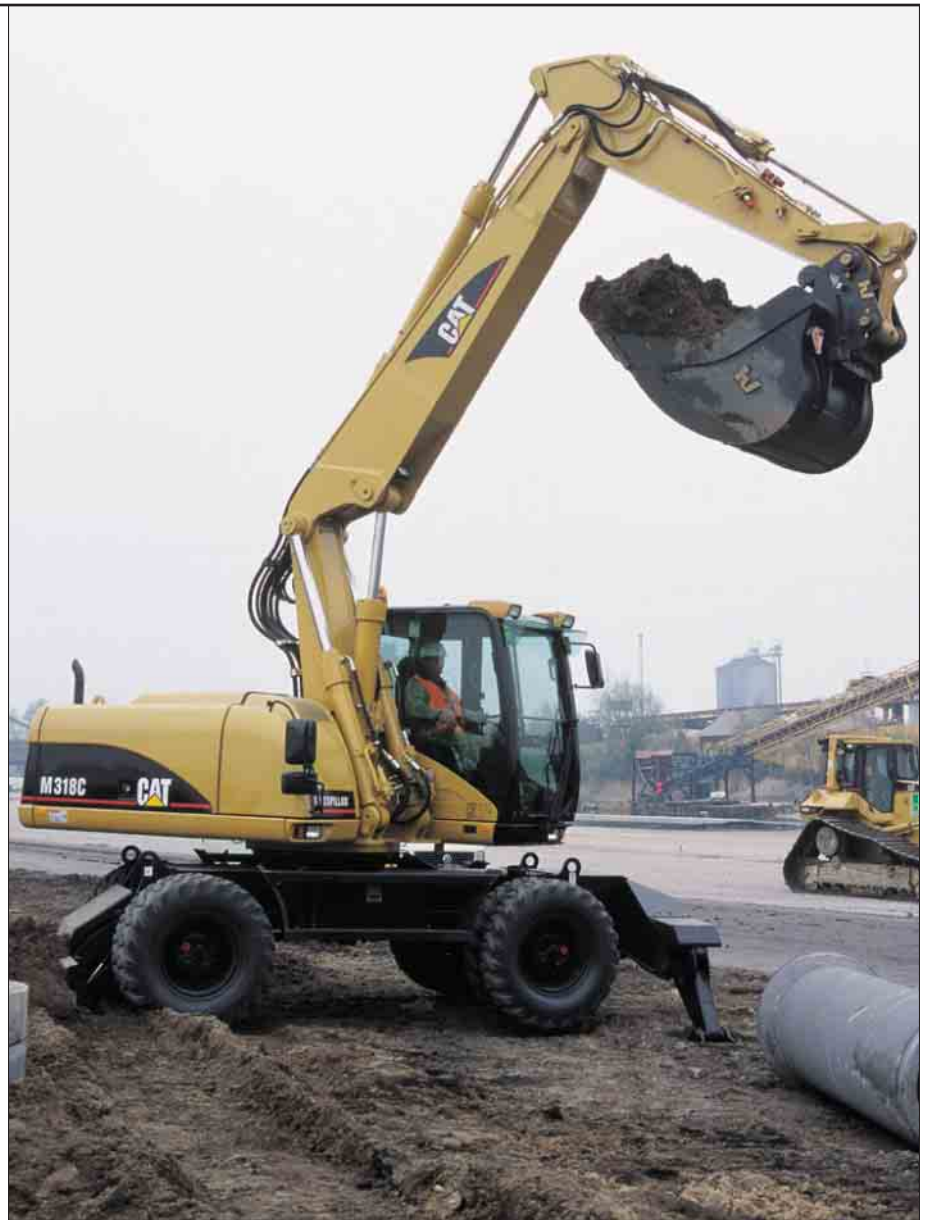

Buckets and Teeth

A wide variety of buckets help optimize machine performance. Purpose designed and built to Caterpillar's high durability standards.

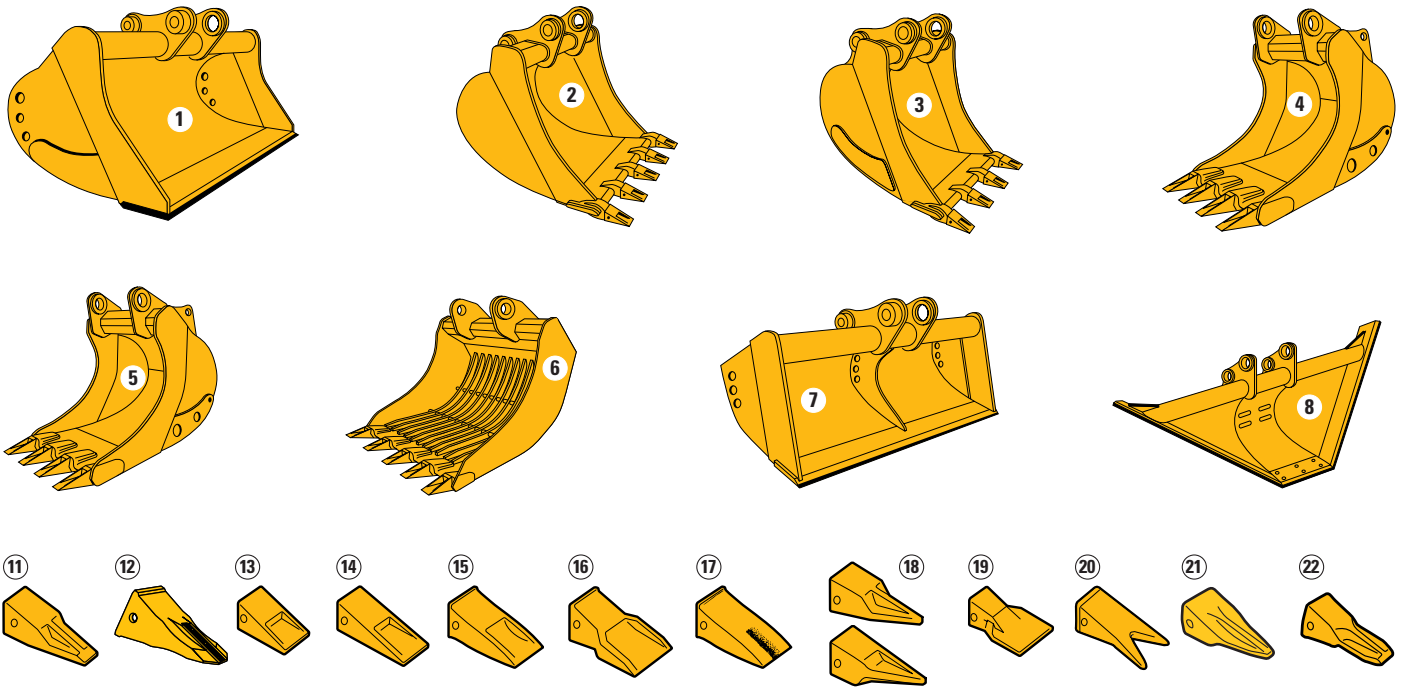

1 Utility Light (LU). Low cost earth working bucket for floor, bank and ditch finishing.

Utility Standard (SU). Demolition and construction bucket handles bricks and broken concrete, as well as trench filling, floor leveling and bank finishing.

2 Excavation/Trenching (X). Digs and loads soft to medium materials such as clay and earth. Features weld on tip adapters, hardened cutting edge and side bars.

3 Extreme Excavation/Trenching (EX). Digs and loads compact/abrasive materials like earth/rock, sand/clay, sand/gravel, coal, chalk and low abrasion ores. Features bigger ground engaging tools, plus abrasion resistant steel for all wear parts.

4 Rock Loading (RL). Loads large blocks of rock and other abrasive materials. Features longer floor plate and increased side bar curvature for better stability under load.

5 Block Handling (BH). Handles pre-shaped blocks of quarry marble and granite. Features increased tip radius, deep-cut side bars for long-floor platform.

6 Skeleton Light (SL). For soft and moist soils and for applications where separation of materials, e.g., branches, peatmoss, is required.

Skeleton Heavy Duty (SH). As S.L., but for more demanding separation work such as sorting rock from sand or gravel on demolition sites.

7 Ditch Cleaning (DC). Wide, light bucket used mainly with long-reach configurations to clean water beds and banks.

8 Trapezoidal (T). To prepare and maintain small irrigation ditches. Features angled sides to shape ditch banks in one operation.

All Cat buckets can be fitted for Caterpillar Quick Coupler.

Tip selection

- 11** Penetration
- 12** Penetration Long Life
- 13** Short
- 14** Long
- 15** Heavy-duty Long
- 16** Heavy-duty Abrasion
- 17** Heavy-duty Long Life
- 18** Sharp / Corner Sharp
- 19** Wide
- 20** Twin Sharp
- 21** Long Sharp
- 22** Penetration Plus

Tool Control System, Quick Couplers and Work Tools

User-friendly, integrated electro-hydraulics make changing tools easy and quick and allow the operator to focus on efficient work.

Tool Controller. Five hydraulic pump flow and pressure settings can be preset on the WEX Multipro, eliminating the need to adjust the hydraulics each time a tool is changed. Selecting the proper setting from the WEX Multipro's menu instantly provides the operator with the optimal hydraulic settings for the specified tool.

Quick Coupler. Caterpillar Quick Couplers provide quick tool exchange time while maintaining top machine performance.

- The universal Quick Coupler hydraulic circuit avoids difficult and costly retrofitting of Quick Coupler hydraulics and allows use of the most frequently used Quick Coupler systems. Ask your Cat dealer for more specific information.
- The hydraulic version is available in the standard and narrow version and makes it easy for the operator to switch tools without leaving the cab.
- The spindle version is a userfriendly mechanical version that can later be converted into the hydraulic version if required. The spindle version is also available in the narrow and standard version.
- A lifting hook can be added to the Quick Coupler for maximum lift capacity.
- The new Cat CW-Series Quick Couplers make it possible for the operator to simply release one work tool and pick up the next, making your wheel excavator highly versatile. The Cat CW-Series Quick Couplers maximize machine efficiency in a cost-effective way.



Hammer. Cat hammers with a wide variety of tools provide the perfect match of maximum life, efficiency and productivity.

Demolition and Sorting Grapple. The demolition and sorting grapple with unlimited left and right rotation is the ideal tool for stripping, sorting, handling and loading.

Clamshell. For some trenching applications or jobs being performed on inner city roads, a clamshell provides an ideal solution. The free-swinging tool makes it possible to dig small sized holes easily.

Maximum Uptime – Service and Maintenance

Extended service intervals and easy access reduce operating costs.



Extended Service Intervals. M318C service and maintenance intervals have been extended to reduce machine service time, increase machine availability and reduce operating costs. Using S•O•S hydraulic oil change intervals can be extended from 2000 hours to 4000 hours. Engine coolant change intervals are up to 6000 hours when Cat Extended Life Coolant/Anti-Freeze is used.

Easy, Wide Open Access. Gull-wing doors with pneumatically assisted lift cylinders lift up effortlessly for excellent access to the engine and all service points.

Easy to Clean Coolers. Flat fins on all coolers reduce clogging and make it easier to remove debris.

Ground Level Service. The design and layout of the M318C was made with the service technician in mind. The fuel water separator, engine oil filter, battery, radiator fluid level, fuel filter, engine oil gauge, hydraulic oil level, air cleaner and pilot system filter are all easily accessible at ground level allowing critical maintenance to be done quickly and efficiently.

Front Compartment. The front service compartment provides ground level access to the batteries, ATAAC, AC condenser and the air filter.

Swing-Up AC Condenser. Without using tools, the AC condenser swings up vertically to allow cleaning on both sides as well as clear access to the ATAAC.



Fuel Tank Drain. Located at the bottom of the upper frame, the fuel tank drain with a hose connection allows simple, spill free fluid draining.

Air Filter. Caterpillar Radial Seal air filters do not require tools to service them, thus reducing maintenance time. The air filter features a double-element construction and built-in precleaner for superior cleaning efficiency. When the air cleaner plugs, a warning is displayed on the monitor screen inside the cab.

Capsule Filter. The hydraulic return filter, a capsule filter, is situated inside the hydraulic tank. This filter prevents contaminants from entering the system when hydraulic oil is changed and keeps the operation clean.

Engine Inspection. The engine can be accessed from both ground level and from the upper structure. The longitudinal layout ensures that all daily inspection items can be accessed from ground level. The engine and pump compartment are separated by a steel wall.

Water Separator. The water separator removes water from fuel even when under pressure and is located in the engine compartment.

Remote Greasing Block. A greasing block located in the engine compartment with two grease points for the swing bearing and one for the front end attachment delivers grease to hard-to-reach locations.

Hydraulic Tank Drain. The hydraulic tank drain enables simple, spill-free fluid changes.

Handrails and Steps. Well-sized handrails and steps assist the operator in climbing on and off of the machine.

Diagnostics and Monitoring. The M318C is equipped with S•O•S sampling ports for the hydraulic system and engine oil. A connection for the Electronic Technician (ET) is conveniently located in the cab.

Anti-Skid "Punched-Star" Plate. An anti-skid punched-star plate covers the top of the steps and the upper structure to prevent slipping during maintenance.

Electronic Technician (ET).

The electronic engine and machine controllers provide detailed diagnostic possibility for service technicians. The ability to store both active and intermittent indicators simplifies problem diagnosis and reduces total repair time, resulting in improved machine availability and lower operating cost. ET can be used to...

- access data stored in the engine and transmission controls via the Cat Data Link System
- display the status of parameters such as engine speed, gear engaged, control switch position, etc.
- view active and non-active diagnostic codes and clear them after repair
- perform diagnostic tests and calibrations of electro-hydraulic components
- view current configuration and change parameter settings
- flash new Caterpillar software into the Electronic Control Modules

A customer version of ET is also available for your fleet of Caterpillar equipment. Contact your Caterpillar dealer

Caterpillar Product Link System

Attachment. Product Link includes a transceiver module (on-board the machine), office application PC software, and a satellite communications network to track machine hours, location, and warnings. Product Link simplifies maintenance scheduling, fleet management, unauthorized machine usage or movement, and product problem event tracking and diagnosis (PL-201). Available in two versions, there is a Product Link system for most customers needs. See your Caterpillar dealer.

Scheduled Oil Sampling (S•O•S)

Analysis. Caterpillar has specially developed S•O•S to help ensure better performance, longer life and increased customer satisfaction. It is a thorough and reliable early warning system which detects traces of metals, dirt and other contaminants in your engine, axle and hydraulic oil. It can predict potential trouble early, thus avoiding costly failures. Your Caterpillar dealer can give you results and specific recommendations shortly after receiving your sample. Each S•O•S test can provide specific types of diagnosis:

- **Oil condition analysis** identifies loss of lubricating properties by quantifying combustion products such as soot, sulfur, oxidation and nitrates.
- **Wear analysis** monitors component wear by detecting, identifying and assessing the amount and type of metal wear elements found in the oil.
- **Chemical and physical test** detect the physical presence of unwanted fluids (water, fuel, antifreeze).

Lower Operating Costs

Improvements in operating costs provide a long-term investment.



Fuel Consumption. The new EU Stage II (US EPA Tier II), electronically controlled engine, new Bosch fuel injection system and new ATAAC combine to provide outstanding fuel consumption during both production and traveling. The Automatic Engine Speed Control reduces idle speed when the implements are not active to further improve fuel consumption.

Filter Change Intervals. 2000 hours hydraulic oil and 500 hours engine oil filter change intervals save time and money.

Hydraulic Oil Change Intervals.

With the aid of S•O•S sampling hydraulic oil change intervals can be extended from 2000 hours to an average of 4000 hours.

Your Caterpillar dealer can provide you with detailed calculations and simulations of how our low operating costs can benefit your particular application.

Maximum uptime – Reliability

Caterpillar standard features help to increase machine uptime.

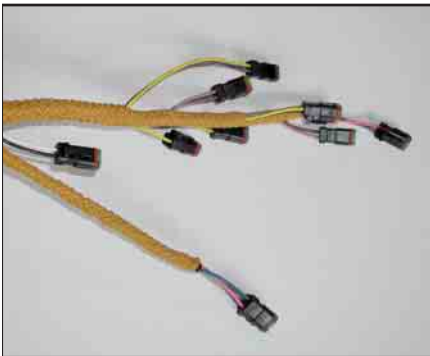

Caterpillar Braided Harnesses.

Designed and manufactured to resist the most severe conditions. Harnesses are made of large section, colored and number-coded wires, with the complete harness being protected by an abrasion resistant braiding. Harnesses are properly routed and securely clamped to ensure their reliability and life.

XT-6 ES Hoses. Premium quality rubber, precision 4-ply wire reinforcement and exclusive reusable couplings are all unique features of Cat hoses which deliver top performance and long life. O-Ring face seals provide positive sealing for reliable and leak-free connections.

Caterpillar Batteries. Caterpillar maintenance-free, high output batteries are designed for high cranking power and maximum protection against vibration.

Fuel Filters. Cat high efficiency fuel filters with a Stay-Clean Valve™ feature cellulose/synthetic blend media that remove more than 98 percent of particles that are two microns or larger, increasing fuel injector life.

Complete Customer Support

Cat dealer services help you operate longer with lower costs.

Services. Customer Service is critical today in every business. That's why so many people buy Cat equipment. They know they are getting quality reliability and performance backed-up with the best Customer Service. Your Caterpillar dealer offers a wide range of services that can be set up under a Customer Support Agreement. The dealer will help you choose a plan that can cover the whole machine including work tools, to help you to get the best out of your investment.

Product Support. You will find a solution for your parts requirements at your dealer. Cat dealers utilize a worldwide network to find in-stock parts to minimize downtime. In addition your dealer can offer alternative solutions like Reman, Classic Parts and quality used parts to save money on original Caterpillar components.

Service Capability. Whether in the dealer's fully equipped shop or in the field, you will get highly trained service technicians using the latest technology and tools.

Maintenance. More and more equipment buyers are planning for effective maintenance before buying equipment. Choose from your dealer's wide range of maintenance services at the time you purchase your machine. Repair option programs guarantee the cost of repairs up front. Diagnostic programs such as S•O•S Fluid Analysis and Technical Analysis help you avoid unscheduled repairs.



Selection. Make detailed comparisons of the machines you are considering before you buy. How long do components last? What is the cost of preventive maintenance? Your Cat dealer can give you precise answers to these questions to make sure you operate your machines at the lowest cost.

Purchase. Consider the financing options available as well as day-to-day operating costs. This is also the time to look at dealer services that can be included in the cost of the machine to yield lower equipment and owning and operating costs over the long run.

Operation. Improving operating techniques can boost your profits. Your Cat dealer has training material and ideas to help you increase productivity.

Replacement. Repair, rebuild or replace? Your Cat dealer can help you evaluate the cost involved so you can make the right choice.

Engine

Cat 3056E ATAAC diesel engine	
Ratings	2000 rpm
Gross power	119 kW/159 hp
Net power	
ISO 9249	113 kW/151 hp
EEC 80/1269	113 kW/151 hp
Bore	100 mm
Stroke	127 mm
Displacement	6.0 liters
Cylinders	6
Maximum torque at 1400 rpm	675 Nm

- The 3056E engine meets EU directive 97/68/EC Stage II emission requirements.
- Net power advertised is the power available at the flywheel when the engine is equipped with fan, air cleaner, muffler, and alternator.
- No engine derating is required below 3000 m altitude.

Swing Mechanism

Swing speed	10.5 rpm
Swing torque	45.7 kNm
Maximum flow	112 l/min
Maximum pressure	310 bar

Tires

- Standard
- Dual pneumatic 10.00-20
- Optional
- 10.00-20 (dual solid rubber)
 - 18R 19.5 XF (single)
 - 600/40-22.5 (single)

Hydraulic System

Tank capacity	170 liters
System	255 liters
Maximum pressure	
Implements	350 bar
Travel	350 bar
Maximum flow	288 and 112 l/min
Pilot system	
Maximum pressure	31 bar

Transmission

1st gear, forward/reverse	9 km/h
2nd gear, forward/reverse	20/25/30/34 km/h
Creeper speed (first gear)	4 km/h
Creeper speed (second gear)	13 km/h
Drawbar pull	96.6 kN
Maximum Gradeability	61.5%

Service Refill Capacities

	Liter
Fuel tank capacity	385
Cooling	39
Engine crankcase	18
Rear axle housing (differential)	11
Front steering axle (differential)	8
Final drive	
Disk brakes	2
Drum brake	1.2
Powershift transmission	3

Cab

Cab/FOGS meets ISO 10262.

Sound

Low sound, low vibration. The 3056E design improves operator comfort by reducing sound and vibration. The M318C was awarded the German Blue Angel for low spectator sound levels.

Operator Sound

- The operator sound level measured according to the procedures specified in ISO 6396:1992 is L_{PA} 72 dB(A), for cab offered by Caterpillar, when properly installed and maintained and tested with the doors and windows closed.
- Hearing protection may be needed when operating with an open cab for extended periods or in a noisy environment.

Exterior Sound

- The labeled spectator sound power level measured according to the test procedures and conditions specified in 2000/14/EC is L_{WA} 102 dB(A).

Weights

Average operating weights include a general purpose bucket, 100% fuel and an operator.

VA boom	kg
rear dozer only	18 300
rear dozer, front outriggers	19 350
front and rear outriggers	19 650
One-piece boom	
rear dozer only	17 800
rear dozer, front outriggers	18 850
front and rear outriggers	19 150
Dozer blade	760
Outriggers	1020
Counterweight	4000

Dimensions

All dimensions are approximate – measured in mm

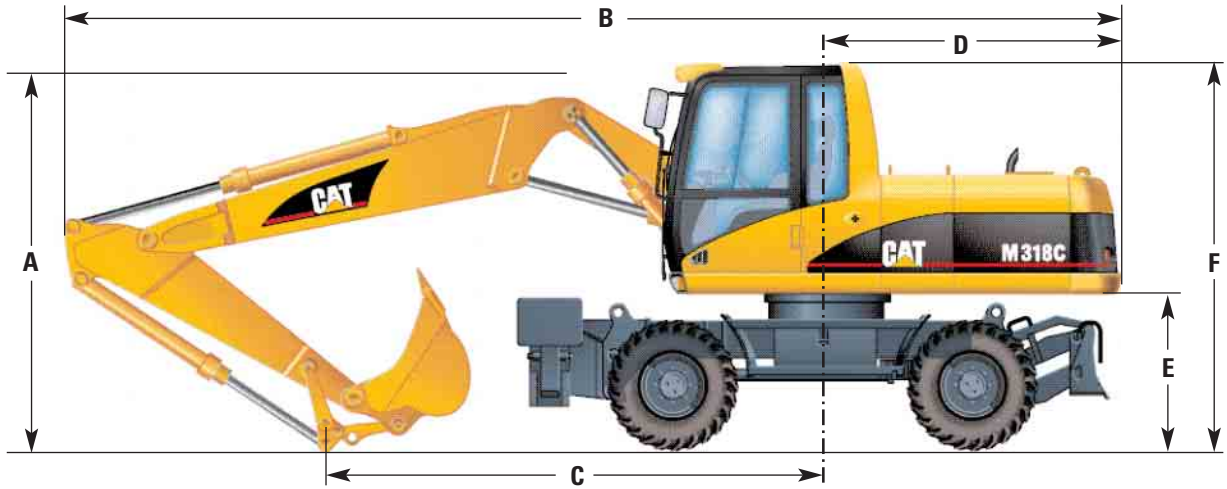

	VA boom mm	One-piece boom mm
A Shipping height		
2200 mm stick	cab height	3190
2500 mm stick	cab height	3210
2800 mm stick	3300	3330
B Shipping length		
2200 mm stick	8870	8870
2500 mm stick	8850	8960
2800 mm stick	8820	8950
C Support Point		
2200 mm stick	3920	3810
2500 mm stick	3650	3490
2800 mm stick	3510	3310
D Tail swing radius	2500	2500
E Counterweight clearance	1275	1275
F Cab height	3170	3170

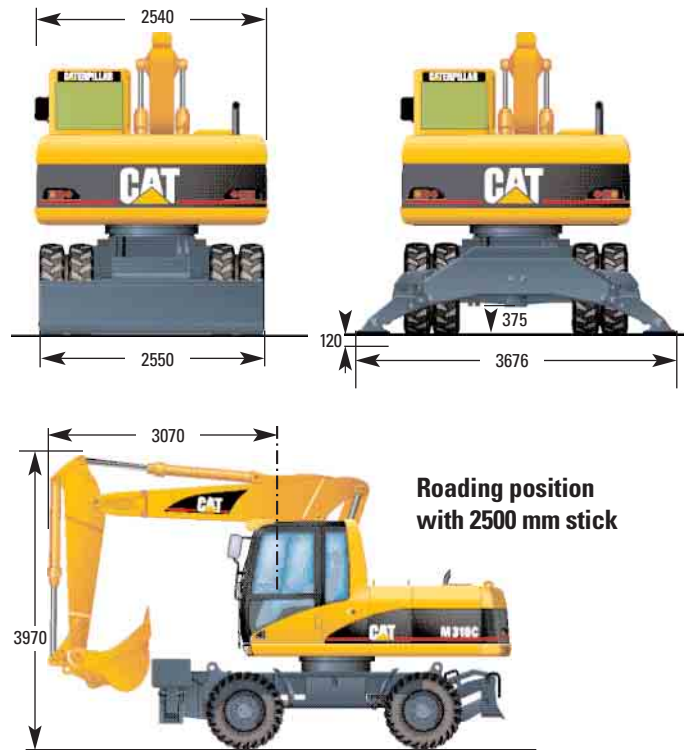

Undercarriage with dozer only

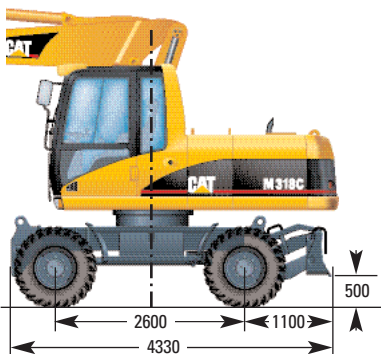

Undercarriage with 2 sets of outriggers

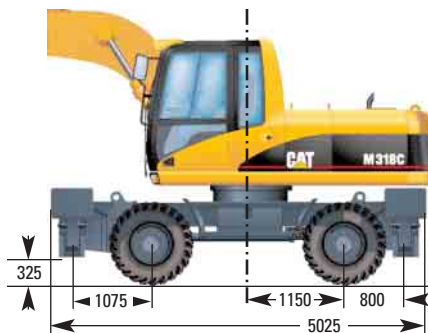

Undercarriage with 1 set of outriggers and dozer

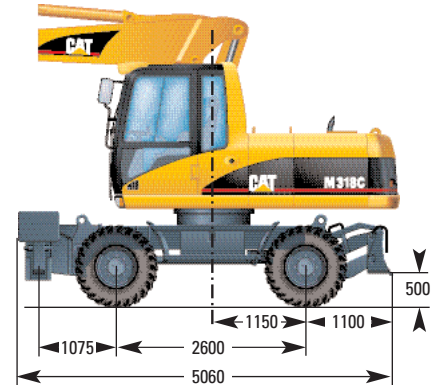

Bucket Specifications

Contact your Caterpillar dealer for special bucket requirements.
Buckets are available to fit the Cat quick coupler.

Buckets without Quick Coupler

Bucket type/stick length	Width	Weight	Capacity (SAE)	5260 mm Variable adjustable boom			5350 mm One-piece boom		
	mm	kg	m ³	2200 mm	2500 mm	2800 mm	2200 mm	2500 mm	2800 mm
Excavation	600	450	0.36						
	750	473	0.48						
	900	520	0.61						
	1000	552	0.70						
	1100	600	0.82			×			×
	1200	633	0.91			×			×
	1300	664	0.99		×	×		×	×
	1400	702	1.09		×	N		×	N
Extreme Excavation	1200	667	0.91			×			×
	1300	700	0.99		×	×		×	×
Ditch Cleaning, tiltable	1800	735	0.47						
	2000	770	0.53						

Buckets and Quick Coupler

Bucket type/stick length	Width	Weight	Capacity (SAE)	5260 mm Variable adjustable boom			5350 mm One-piece boom		
	mm	kg	m ³	2200 mm	2500 mm	2800 mm	2200 mm	2500 mm	2800 mm
Excavation	600	427	0.35						
	750	471	0.48						
	900	485	0.61						
	1000	516	0.70						
	1100	566	0.82			×			×
	1200	606	0.91		×	×		×	×
	1300	637	0.99	×	×	N	×	×	×
	1400	675	1.09	×	N	N	×	N	N
Extreme Excavation	1200	641	0.91		×	×		×	×
	1300	673	0.99	×	×	N	×	×	N
Ditch Cleaning	1800	488	0.63						
	2000	557	0.83						
Ditch Cleaning, tiltable	1800	867	0.76			×			×
	2000	911	0.84		×	N		×	N

















 Max. Material density
1800 kg/m³

 Not recommended for dozer down
stabilization only















 Not recommended for free on
wheels operation

Lift capacities

















with 5260 mm Variable adjustable boom and Quick Coupler CW. All weights are in kg.

Stick 2200 mm		Undercarriage configuration	3.0 m			4.5 m			6.0 m			7.5 m						m
																		
6.0 m	Rear dozer up				*5800			5000	4900									
	Rear dozer down				*5800	*5800		5700		*5300								
	Rear stab down				*5800	*5800			*5300	4200								
	2 sets stab down Dozer and stab down				*5800	*5800		*5800	*5300									
4.5 m	Rear dozer up	*8700		*8700	*6700			4900	4900									
	Rear dozer down		*8700	*8700	*6700	*6700		5500		*5600								
	Rear stab down		*8700	*8700	*6700	*6700		6600		*5600								
	2 sets stab down Dozer and stab down	*8700	*8700	*8700	*6700	*6700		*6700	*5600									
3.0 m	Rear dozer up	*8800		8600	7400			4700	4900									
	Rear dozer down		*8800	*8800		*8100		5400		*6200								
	Rear stab down		*8800	*8800		*8100		6400		*6200								
	2 sets stab down Dozer and stab down	*8800	*8800	*8800	*8100	*8100		*8100	*6200									
1.5 m	Rear dozer up	*11 400		8300	7300			4700	4900									
	Rear dozer down		*11 400	*9600		*9200		5300		*6600								
	Rear stab down		*11 400	*11 400		*9200		*6300		*6400								
	2 sets stab down Dozer and stab down	*11 400	*11 400	*11 400	*9200	*9200		8800	*6600									
Ground	Rear dozer up	*13 900		8100	*7300			4500	4700									
	Rear dozer down		*13 900	9500		*9400		5200		*6800								
	Rear stab down		*13 900	11 900		*9400		6300		6500								
	2 sets stab down Dozer and stab down	*13 900	*13 900	*13 900	*9400	*9400		*8900	*6800									
-1.5 m	Rear dozer up	14 500		7800	7300			4300	4400									
	Rear dozer down		*15 200	9200		*9500		5000		*6900								
	Rear stab down		*15 200	11 700		*9500		6100		6400								
	2 sets stab down Dozer and stab down	*15 200	*15 200	15 200	*9500	*9500		9200	*6900									
-3.0 m	Rear dozer up	14 700		7800	7000			4100	4300									
	Rear dozer down		*15 700	9200		*9300		4700		*4600								
	Rear stab down		*15 700	11 700		*9300		5800		*4600								
	2 sets stab down Dozer and stab down	*15 700	*15 700	*15 700	*9300	*9300		8900	*4600									

Stick 2500 mm

Stick 2500 mm		Undercarriage configuration	3.0 m			4.5 m			6.0 m			7.5 m						m
																		
6.0 m	Rear dozer up									*4800								
	Rear dozer down										*4800							
	Rear stab down									*4800								
	2 sets stab down Dozer and stab down									*4800								
4.5 m	Rear dozer up				*6200			4900	4900									
	Rear dozer down					*6200		5500		*5400								
	Rear stab down					*6200		6200		*5400								
	2 sets stab down Dozer and stab down				*6200	*6200		*6200	*5400									
3.0 m	Rear dozer up	*9500		8500	7400			4700	4800									
	Rear dozer down		*9500	*9500		*7800		5400		*6000								
	Rear stab down		*9500	*9500		*7800		6400		*6000								
	2 sets stab down Dozer and stab down	*9500	*9500	*9500	*7800	*7800		*7800	*6000									
1.5 m	Rear dozer up	*11 200		8300	7300			4600	4800									
	Rear dozer down		*11 200	9500		*9000		5300		*6500								
	Rear stab down		*11 200	*11 200		*9000		*6300		6400								
	2 sets stab down Dozer and stab down	*11 200	*11 200	*11 200	*9000	*9000		8800	*6500									
Ground	Rear dozer up	*13 300		8200	7300			4500	4700									
	Rear dozer down		*13 300	9600		*9300		5200		*6700								
	Rear stab down		*13 300	11 800		*9300		6300		6400								
	2 sets stab down Dozer and stab down	*13 300	*13 300	*13 300	*9300	*9300		*8800	*6700									
-1.5 m	Rear dozer up	14 300		7800	7300			4300	*4500									
	Rear dozer down		*15 100	9200		*9400		5000		*6900								
	Rear stab down		*15 100	11 700		*9400		6100		6400								
	2 sets stab down Dozer and stab down	*15 100	*15 100	15 100	*9400	*9400		9000	*6900									
-3.0 m	Rear dozer up	14 600		7800	7000			4100	4300									
	Rear dozer down		*15 600	9100		*9700		4800		*5700								
	Rear stab down		*15 600	11 600		*9700		5900		*5700								
	2 sets stab down Dozer and stab down	*15 600	*15 600	*15 600	*9700	*9700		9000	*5700									
-4.5 m	Rear dozer up	*11 400		7600														
	Rear dozer down		*11 400	9000														
	Rear stab down		*11 400	*11 400														
	2 sets stab down Dozer and stab down	*11 400	*11 400	*11 400														

Stick
2800 mm























		Undercarriage configuration	3.0 m			4.5 m			6.0 m			7.5 m						m
																		
6.0 m		Rear dozer up Rear dozer down Rear stab down 2 sets stab down Dozer and stab down							*4400		3200							
										*4400	3700							
										*4400	4300							
											*4400							
											*4400							
											*4400							
4.5 m		Rear dozer up Rear dozer down Rear stab down 2 sets stab down Dozer and stab down				*5300		4900	*4900		3200	3400		2100				
							*5300	*5300		*5100	3600		*3800	2400				
								*5300		*5100	4300		*3800	2900				
						*5300		*5300	*5100		*5100	*3800		*3800				
						*5300		*5300	*5100		*5100	*3800		*3800				
3.0 m		Rear dozer up Rear dozer down Rear stab down 2 sets stab down Dozer and stab down	*9300		8600	*7400		4800	4800		3100	3400		2100	*1900		1500	8.80
				*9300	*9300		*7400	5400		*5800	3500		2400		*1900	1700		
				*9300	*9300		*7400	6400		*5800	4200	*4900	2900		*1900	*1900		
				*9300	*9300	*7400		*7400	*5800		*5800	4100		*1900	*1900	*1900		
				*9300	*9300	*7400		*7400	*5800		5000	*4900	3500	*1900	*1900	*1900		
1.5 m		Rear dozer up Rear dozer down Rear stab down 2 sets stab down Dozer and stab down	*11 700		8300	7200		4600	4800		3100	3300		2000	*2000		1400	8.89
				*11 700	9500		*8700	5300		*6400	3500		2300		*2000	1700		
				*11 700	11 700		*8700	6200		*6400	4200	5000	2800		*2000	*2000		
				*11 700	*11 700	*8700		*8700	*6400		5800	*5100	4100	*2000	*2000	*2000		
				*11 700	*11 700	*8700		7400	*6400		4900	*5100	3400	*2000	*2000	*2000		
Ground		Rear dozer up Rear dozer down Rear stab down 2 sets stab down Dozer and stab down	*13 200		8300	7200		4600	*4800		3000	3200		1900	*2200		1400	8.69
				*13 200	9500		*9300	5200		*6700	3400		2200		*2200	1700		
				*13 200	11 700		*9300	6300		*6400	4100	5000	2700		*2200	2100		
				*13 200	*13 200	*9300		*8800	*6700		5800	*5200	4000	*2200	*2200	*2200		
				*13 200	*13 200	*9300		7500	*6700		4900	*5200	3300	*2200	*2200	*2200		
-1.5 m		Rear dozer up Rear dozer down Rear stab down 2 sets stab down Dozer and stab down	14 200		7800	7300		4300	4500		2700	3100		1800	*2500		1600	8.17
				*14 900	9200		*9400	5000		*6800	3200		2100		*2500	1800		
				*14 900	11 700		*9400	6100		6500	3900	*4700	2600		*2500	2300		
				*14 900	*14 900	*9400		8900	*6800		5700	*4700	3900	*2500	*2500	*2500		
				*14 900	14 500	*9400		7500	*6800		4700	*4700	3200	*2500	*2500	*2500		
-3.0 m		Rear dozer up Rear dozer down Rear stab down 2 sets stab down Dozer and stab down	14 500		7700	7100		4200	4300		2600				*3100		1900	7.27
				*15 400	9100		*9700	4800		*6300	3000				*3100	2200		
				*15 400	11 600		*9700	6000		6300	3700				*3100	2800		
				*15 400	*15 400	*9700		9000	*6300		5500				*3100	*3100		
				*15 400	15 000	*9700		7400	*6300		4500				*3100	*3100		
-4.5 m		Rear dozer up Rear dozer down Rear stab down 2 sets stab down Dozer and stab down	*13 200		7600	*6500		4000										
				*13 200	9000		*6500	4600										
				*13 200	11 500		*6500	5700										
				*13 200	*13 200	*6500		*6500										
				*13 200	*13 200	*6500		*6500										

























* Limited by hydraulic rather than tipping load.
The above loads are in compliance with hydraulic excavator lift capacity ratings standard ISO 10567, they do not exceed 87% of hydraulic lifting capacity or 75% of tipping capacity. Weight of all tools and lifting accessories must be deducted from the above lifting capacities.

Lift capacities

with 5350 mm One-piece boom and Quick Coupler CW. All weights are in kg.

Stick 2200 mm		Undercarriage configuration	3.0 m			4.5 m			6.0 m			7.5 m						m
																		
6.0 m		Rear dozer up							4900		3100							
		Rear dozer down								*5200	3500							
4.5 m		Rear dozer up				*6500		4700	4800		3000							
		Rear dozer down					*6500	5400			*5500	3400						
3.0 m		Rear dozer up				7200		4300	4600		2800	3200	2000	2900		1700	8.22	
		Rear dozer down					*8000	5000			*6100	3200	2300	2800		2000		
1.5 m		Rear dozer up				6800		4000	4400		2700	3200	1900	2700		1700	8.31	
		Rear dozer down					*9200	4600			*6600	3100	2200	2700		1900		
Ground		Rear dozer up				6600		3800	4300		2600	3100	1900	2800		1700	8.09	
		Rear dozer down					*9400	4400			*6800	3000	2200	2800		1900		
-1.5 m		Rear dozer up				6500		3800	4200		2500			3100		1900	7.53	
		Rear dozer down					*8800	4400			*6500	2900	2200	2700		2200		
-3.0 m		Rear dozer up	*9800		7100	6600		3800	4300		2600			3900		2300	6.53	
		Rear dozer down		*9800	8400		*7300	4400			*5100	3000	2200	2700		2200		

Stick 2500 mm

Stick 2500 mm		Undercarriage configuration	3.0 m			4.5 m			6.0 m			7.5 m						m
																		
6.0 m		Rear dozer up								*4800	3100							
		Rear dozer down									*4800	3500						
4.5 m		Rear dozer up							4800		3000	3300	2000					
		Rear dozer down									*5200	3400	2300					
3.0 m		Rear dozer up				7300		4400	4600		2900	3200	2000	*2300		1600	8.53	
		Rear dozer down					*7700	5000			*5900	3300	2200	2300		1900		
1.5 m		Rear dozer up				6800		4000	4400		2700	3200	1900	*2500		1500	8.62	
		Rear dozer down					*9000	4600			*6500	3100	2200	2700		1800		
Ground		Rear dozer up				6600		3800	4300		2500	3100	1800	2600		1600	8.41	
		Rear dozer down					*9400	4400			*6800	2900	2100	2700		1800		
-1.5 m		Rear dozer up	*8100		6800	6500		3700	4200		2500			2900		1700	7.88	
		Rear dozer down		*8100	8100		*9000	4300			*6600	2900	2200	2700		2200		
-3.0 m		Rear dozer up				7000		3800	4200		2500			3500		2100	6.93	
		Rear dozer down		*10 600	8300		*7700	4400			*5500	2900	2200	2700		2400		
-4.5 m		Rear dozer up				*4800		4000										
		Rear dozer down					*4800	4600										

VA Boom Working Ranges

5260 mm Variable adjustable boom, quick coupler and bucket

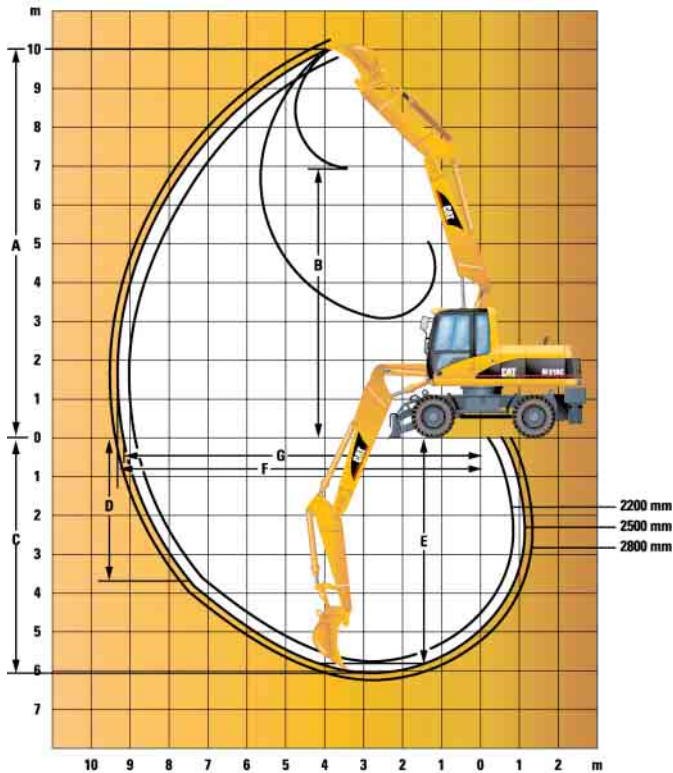

Stick Length	mm	2200	2500	2800
A Maximum Digging Height	mm	9710	10 000	10 210
B Maximum Dump Height	mm	6700	6970	7190
C Maximum Digging Depth	mm	5750	6060	6360
D Maximum Vertical Wall Digging Depth	mm	3220	3680	3960
E Maximum Depth 2500 mm Straight Clean-up	mm	5538	5865	6179
F Maximum Reach	mm	9160	9470	9760
G Maximum Reach at Ground Level	mm	8970	9300	9590
Bucket Forces (ISO 6015)	kN	118	118	118
Stick Forces (ISO 6015)	kN	95	85	79

One-piece Boom Working Ranges

5350 mm One-piece boom, quick coupler and bucket

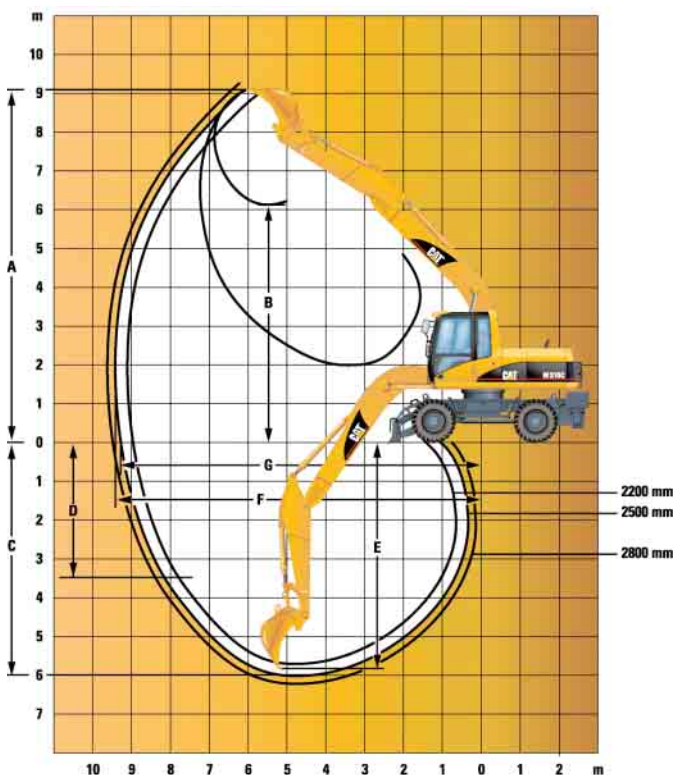

Stick Length	mm	2200	2500	2800
A Maximum Digging Height	mm	8760	9010	9170
B Maximum Dump Height	mm	5900	6110	6270
C Maximum Digging Depth	mm	5700	6000	6300
D Maximum Vertical Wall Digging Depth	mm	2880	3340	3620
E Maximum Depth 2500 mm Straight Clean-up	mm	5488	5805	6119
F Maximum Reach	mm	9180	9490	9770
G Maximum Reach at Ground Level	mm	9000	9320	9600
Bucket Forces (ISO 6015)	kN	118	118	118
Stick Forces (ISO 6015)	kN	95	85	79

Standard Equipment

Standard equipment may vary. Consult your Caterpillar dealer for specifics.

Operator Station

Ash tray with cigarette lighter
Bi-level air conditioner with automatic climate control
Bolt-on FOGS capability
Bottom mounted parallel wiper and washer
Coat hook
Drink holder
Filtered ventilation
Floormat, washable
Fully adjustable suspension seat
Heater and defroster
Joysticks, adjustable
LH console, tiltable
Light, interior
Literature holder
Low fuel indicator light
Openable two-piece front windscreen
Parking brake
Pre-wired radio mounting
Polycarbonate skylight
Power supply 12V – 7A
Retractable seat belt
Steering column, tiltable
Storage compartment suitable for a lunch box
Sun visor

Language display WEX Multipro

Clock with 10 day backup battery
Filter / fluid change information
Gauges for fuel level, engine coolant temperature and hydraulic oil temperature
Headlights indicator
Indicator for engine dial setting
Pre-start level check for hydraulic oil, engine oil and coolant
Turn signal indicator
Warning messages
Working hour information

Engine

Automatic engine speed control
Automatic starting aid
Cat 3056E ATAAC Stage II engine, turbocharged with air-to-air aftercooler
Muffler

Undercarriage

Oscillating front axle
Pin-on design preparation for dozer blade and outriggers
10.00-20 14PR tires
Tool box
Two-piece drive shaft

Hydraulics

Cat X-6 ES hoses
Load-sensing plus hydraulic system
Manual work modes (economy, power, travel)
Oil cooler
Separate swing pump
Stick regeneration circuit

Electrical

Alternator, 55A
Boom working light
Heavy-duty maintenance-free batteries
Horn
Main shut-off switch
Roading lights

Other equipment

Automatic swing brake
Mirrors, frame and cab
Door locks and caps locks with Caterpillar one-key security system

Optional Equipment

Optional equipment may vary. Consult your Caterpillar dealer for specifics.

Operator Station

Falling objects guard
Vandalism guard
WEX comfort seat with seat heating and air suspension
Fixed one-piece front windscreen
Travel speed lock
Visor, rain protection, polycarbonate
Headrest
Lid for storage compartment
Fixed cab riser (1200 mm)

Electrical

Back-up alarm
Refueling pump
Working lights, cab mounted (front and rear)

Booms and Sticks

Hydraulically adjustable boom (5260 mm)
One-piece-boom (5350 mm)
2200 mm stick
2500 mm stick
2800 mm stick

Undercarriage

Dozer blade, front or rear mounted
Optional tires
Outriggers, front or rear mounted
Second tool box
Wide dozer blade, front or rear mounted
Wide gauge axles (2750 mm)

Hydraulics

Control group for quick coupler
Generator valve with priority function
Hammer valve
Hydraulic lines for quick coupler – boom and stick
Lowering control devices for boom and stick
Multifunction valve, provides up to 5 programmed tools and tool selection from the cab (including hammer function)
Synthetic ester based biodegradable hydraulic oil

Other equipment

Cat Machine security system
Cat Product Link
Custom paint

M318C Wheel Excavator

HEHH2839 (11/2002) hr

Materials and specifications are subject to change without notice.
Featured machines in photos may include additional equipment.
See your Caterpillar dealer for available options.

www.CAT.com
© 2002 Caterpillar

CATERPILLAR[®]