

VOLVO WHEEL LOADER

L110E



VOLVO

L110E – THE PRODUCTION LOADER THAT GIVES YOU MORE

With the L110E, we've combined the optimal production loader with the flexible allrounder. Whatever the job, the L110E will get it done quickly and efficiently at the lowest cost. This machine has all the well thought-out features and details to give the results you demand. Volvo L110E - the loader that gives you more, way more.

Volvo has developed and manufactured wheel loaders for half a century. The goal has always been to create the optimal machine for maximum performance and productivity, high operator comfort, and unmatched flexibility. Now, the latest experiences and leading technology have resulted in the Volvo L110E. The high performance, low emission engine delivers close to maximum power already at low rpm. Furthermore, the powerful patented TP linkage, combined with Volvo's purpose-built range of attachments, provides the flexibility needed to handle a variety of tasks. Jobs at which the L110E excels include loading trucks, earthmoving, pallet handling and timber handling. Advanced technology helps to make this a swift, versatile and fuel efficient production machine in any application.

Gets more done

You'll find the L110E a pleasure to operate. In this respect, competing loaders simply can't compete. It's powerful, agile and easy to maneuver. Sitting comfortably in an ergonomically designed seat, you have total control over the machine. Engine and hydraulics respond immediately to your commands. Visibility is panoramic and the air in the cab is always fresh. Both operator and machine get more done with a lot less haste.

A great deal for your investment

Proven reliability, excellent financing, extremely low fuel consumption and a high trade-in value provide the cornerstones of a safe investment. Add to that outstanding handling and productivity, a market-leading operator environment to protect the person in the machine, quick and simple daily maintenance and modest service requirements.

And what do you get? The most cost efficient loader in its class, delivering unparalleled profitability - both now and in years to come.

With the L110E, everybody is a winner. Quite simply, a great deal for your money.



Specifications L110E

Engine:	Volvo D7D LB E2
Max power at SAE J1995 gross ISO 9249,	28,3 r/s (1700 r/m) 155 kW (210 hp)
SAE J1349 net	154 kW (209 hp)
Breakout force:	156,3 kN*
Static tipping load at full turn:	11 160 kg*
Buckets:	2,7–9,5 m ³
Timber grapple:	1,1–2,4 m ²
Operating weight:	18,0–20,0 t
Tires:	23.5 R25 750/65 R25

* Bucket: 3,1 m³ with bolt-on edges, Tires: 23.5 R25 L3



POWER UP YOUR PRODUCTIVITY

Load more tons per hour with the Volvo L110E. Its powerful engine and the Automatic Power Shift (APS) gear shifting system provide immediate response even in the toughest conditions. And Volvo axles are designed to ensure that the rimpull is there when needed. Torque Parallel linkage (TP linkage), load sensing hydraulics, smooth steering and stable operation help make the L110E a precision performer.

The only thing modest about this machine is its fuel consumption

Even at low rpm, the 7-liter high performance engine delivers full power and maximum torque. The machine responds quickly and forcefully with excellent rimpull, full hydraulic power, low fuel consumption and low emissions. And thanks to the low rpm performance, the service life of the engine is extended.

Responds to your commands

The Volvo fully automatic countershaft transmission provides smooth and effective gear shifting. All the operator has to do is select forward or reverse and APS automatically selects the right gear according to both engine rpm and ground speed. Volvo's in-house engineered axles and drivetrain are well matched and designed for top dependability. And Volvo's oil circulation cooled wet disc brakes provide smooth, effective braking - and, of course, a long service life.

Torque Parallel linkage - a breakthrough in the industry

The reliable TP linkage, Volvo's patented lift-arm system, delivers high and even breakout torque throughout the entire lifting range. The system is exceedingly user-friendly. The operator can easily handle heavy materials and maintain full control in all positions.

Hydraulics that make sense

The Volvo L110E features an intelligent load sensing system for both the main and steering hydraulics. Two variable piston pumps provide the exact flow and pressure required at any given moment, distributing power when and where it's needed. In addition to rapid response, this system facilitates smoother operation, lower fuel consumption, and precise control, even at low rpm.

Engine

- Volvo D7D, a turbocharged, air-to-air intercooled low emission engine with electronically controlled fuel injection delivers high torque even at low rpm.
- The electronically controlled hydrostatic fan is only activated when necessary, thus saving fuel.

Transmission

- With Volvo's 3rd generation of APS, the operator can select between four different operating modes, including the new AUTO function, which adaptively chooses the most convenient shifting program for the job at hand, equally weighing the operator's driving habits together with the operating cycle.
- The 3rd generation APS now has fully automatic shifting 1-4, meaning all the operator has to do is choose forward or reverse.

Axles/Brakes

- The Volvo axles are fully integrated with the drivetrain, delivering superior rimpull.
- Oil circulation cooled wet disc brakes ensure effective braking and a long service life.
- An electronic brake test in Contronic gives you instant access to the status of the brakes.
- A brake wear indicator on each wheel allows you to easily check the brake pad wear.

Steering

- Load-sensing steering only uses power when it's needed, thereby saving fuel.
- E-series loaders feature an accumulator system, providing stable, smooth steering and greater safety.

Frame

- Rugged frame design for secure mounting of components increases the service life of the machine.
- Volvo's frame joint bearing design is a well-proven concept that's easy to maintain and renowned for its long service life.



TP linkage

- Unique patented lift-arm system, which provides two solutions in one: excellent breakout torque and parallel action throughout the entire lifting range.

Load-sensing hydraulics

- The load-sensing hydraulic system ensures that hydraulic oil is pumped around the system only when and where it's needed. This means greater efficiency and lower fuel consumption.

- Pilot-operated hydraulics allow precise control of the attachments, making life easier, and safer, for the operator.

* Optional equipment

AN ALERT OPERATOR IS A PRODUCTIVE OPERATOR

Volvo Care Cab with the Contronic monitoring system reinforces Volvo's reputation as a leader in operator environments and cab comfort. We never forget the operator inside the machine. A comfortable, operator-friendly and safe environment makes the workday easier and more productive.



A clean and comfortable workplace

The right cab climate does wonders for efficiency, keeping operators sharp during long shifts. In fact, all incoming air is filtered in two stages, making this one of the cleanest cabs on the market. Even the recirculated air is filtered. Furthermore, Volvo's state-of-the-art air-conditioning* provides a pleasant temperature year-round, regardless of outdoor conditions. So even after a long work shift, the air in the cab is still fresh and the operator's mind is still clear.

Comfort and productivity go hand-in-hand

There is a range of comfortable seats, all of them with multiple adjustment functions for optimal individual comfort. All instruments are visible at a glance, and all important information is right in front of the operator. The forward, reverse and kick-down functions are situated both on the lever on the left-hand side of the steering wheel and on the hydraulic console to the right. And thanks to Comfort Drive Control (CDC)*, you can steer, change directions and kickdown to first gear with easy-to-use controls integrated into the left-hand armrest - an excellent way to combat fatigue and static muscle strain. Furthermore, to avoid monotonous arm movements, you can shift at any time from lever steering to using the steering wheel.

Contronic keeps an eye on everything

Contronic, the highly reliable control and monitoring system from Volvo, continuously monitors the machine's operation and performance. The system is an electronic network made up of three computers. Operating at three levels, the system keeps an eye on the machine's various functions in real-time. If a potential problem should occur, the system generates an immediate warning, making the operator aware of the condition. All operating data is saved and can be used to analyze how the machine performs and also to trace its history since the latest service. The machine's functions can be updated for optimal adaptation to new and changing operating conditions via the Contronic service display tool. With VCADS Pro, it's also possible to check and adjust the machine's functions and performance characteristics.

Low noise levels

Thanks to its ingenious rubber mounting system and heavy-duty insulation, the Care Cab is one of the quietest cabs on the market. By reducing tiresome earfuls and annoying vibrations, the operator will stay sharp throughout the shift. In short, it's a great place to work.

Care Cab

- Unrivalled operator environment with one of the market's best cab filtration systems.
- Pleasant interior with superior finish makes it easy to maintain and keep clean.
- Adjustable seat, armrest, hydraulic lever console and steering wheel* for optimal operator comfort and high production.
- Contronic, a superior control and monitoring system, designed to increase safety and productivity.
- All service platforms and entry ladders boast improved anti-slip surfaces. Sloped entry ladder for easy cab access.
- Large windscreens, narrow pillars and a sloped engine hood ensure good panoramic visibility, thus further increasing safety.
- Powerful halogen lighting to the front and rear provides good visibility over the entire work area.

* Optional equipment

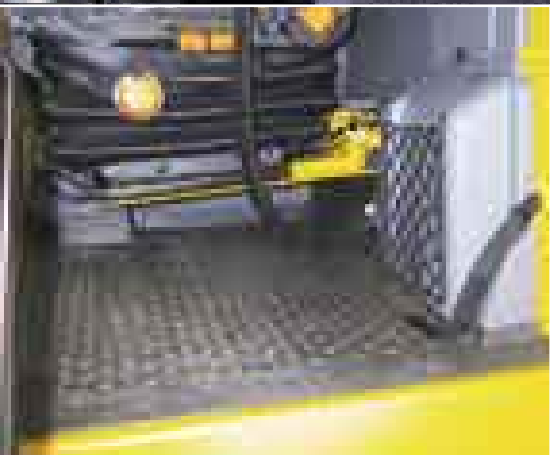

VOLVO'S COMMITMENT TO NATURE AND MANKIND

Quality, safety, and care for the environment are Volvo's core values. Indeed, we see our commitment as an integral part of our operation. Few machines have to work in tougher conditions. The ultimate goal is maximized productivity and efficiency for the lowest cost per hour, with minimized environmental impact. For instance, plants and manufacturing processes are certified in accordance with ISO 14001. This is but one example of our tangible commitments and high quality standards. And that's why Volvo customers get one of the most environmentally considerate and dependable wheel loaders on the market.

A winner for years to come

Your Volvo L110E has to be a winner - both in day-to-day and long-term operations, always operating economically with maximum consideration of the environment. The machinery has to be trusted in all aspects. It must deliver the anticipations of productivity and economy. High quality and easy maintenance are imperative for keeping up the work process. The high performance low emission engine is both good for your business and for the environment.

Comfortable and quiet operator's environment

The operator inside deserves a comfortable, reliable and safe machine to work with. A good environment helps to spare operator, equipment and nature for years to come. The Volvo L110E is a super competitive wheel loader that puts the operator right in the middle, literally speaking. Tedious vibrations and noise have been heavily reduced. If the operator feels comfortable and secure, it's easier to stay attentive.

More than 95% recyclable

The L110E is almost completely recyclable. We see it as a natural step in our commitment. Components such as the engine, transmission and hydraulics are re-engineered and re-used in our Parts Exchange program. The equipment has to be as trustworthy, service-friendly, productive and as cost-effective as possible. Choose this wheel loader for maximum productivity and minimal impact on operator, machinery and environment. Feel free to feel secure in a Volvo L110E.

Quality

- The air is vented from all major components with easy to replace breather filters, used to prevent dirty air from entering the transmission, axles, fuel tank, and hydraulic tank.
- All electrical wires are routed through sturdy conduits, protected from water, dust, and abrasion with rubberized connectors and terminal caps.
- The L110E is designed from the beginning for easy service and maintenance. Easy access to all components lays the foundation for shorter service and maintenance time and longer life.

Safety

- A dual-circuit service brake system that fulfills all requirements according to ISO 3450, electronic brake test in Contronic and easy to check brake wear indicators are all ways to ensure safe and effective braking.
- Volvo Care Cab is tested and approved according to ROPS ISO 3471 and FOPS ISO 3449 standards.
- Optimized panoramic visibility gives effective control over the entire work area.
- The L110E has steps and platforms that are equipped with anti-slip surfaces and well positioned hand rails.

Environment

- The low rpm, high performance D7D engine meets all current emission requirements according to step 2 legislation in Europe and the US.
- The L110E is manufactured in environmentally certified factories according to ISO 14001.
- The L110E is more than 95% recyclable according to material weight.
- Low external and internal sound levels.



VOLVO L110E IN DETAIL

Engine

7 liter, 6-cylinder straight turbocharged diesel engine with electronically controlled unit pumps and conventional injectors. The engine has wet replaceable cylinder liners and replaceable valve guides and valve seats. The throttle application is transmitted electrically from the throttle pedal or the optional hand throttle. Air cleaning: three-stage. Cooling system: Air-to-air intercooler and hydrostatic, electronically controlled fan.

Engine	Volvo D7D LB E2
Max power at	28,3 r/s (1700 r/min)
SAE J1995 gross	155 kW (210 hp)
ISO 9249, SAE J1349	154 kW (209 hp)
Max torque at	23,3 r/s (1400 r/min)
SAE J1995 gross	1023 Nm
ISO 9249, SAE J1349	1014 Nm
Economic working range	1100–1600 r/min
Displacement	7,1 l

Electrical system

Central warning system: Central warning light for the following functions, (buzzer with gear engaged): Engine oil pressure, charge air temperature, fuel temperature, transmission oil pressure, brake pressure, parking brake applied, hydraulic oil level, steering pressure, low coolant level, coolant temperature, transmission oil temperature, hydraulic oil temperature, overspeeding in engaged gear, brake charging, axle oil temperature.

Voltage	24 V
Batteries	2x12 V
Battery capacity	2x140 Ah
Cold cranking capacity, approx	1050 A
Reserve capacity, approx	270 min
Alternator rating	1540 W/55 A
Starter motor output	5,4 kW (7,3 hp)

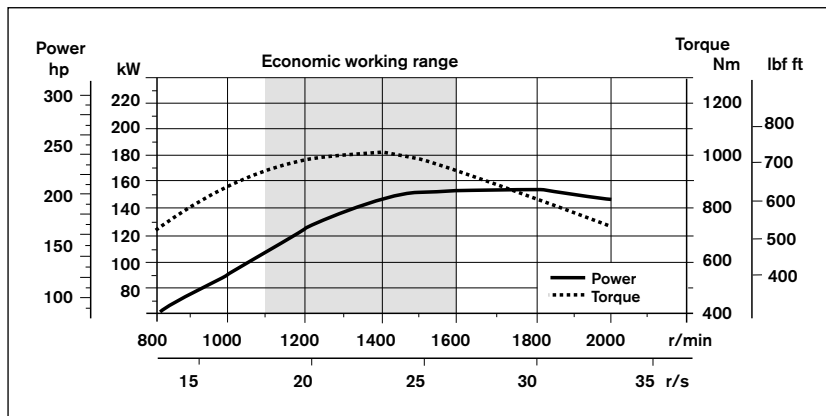

Drivetrain

Torque converter: single-stage. Transmission: Volvo countershaft transmission with single lever control. Fast and smooth shifting of gears between forward and reverse with Pulse Width Modulation (PWM) valve. Gear shifting system: Volvo Automatic Power Shift (APS) with fully automatic shifting 1-4 and mode selector with 4 different gear shifting programs, including AUTO. Axles: Volvo fully floating axle shafts with planetary hub reductions and cast steel axle housings. Fixed front axle and oscillating rear axle. 100% differential lock on the front axle.

Transmission	Volvo HTE 204
Torque multiplication	2,69:1
Maximum speed, forward/reverse	
1	7,1 km/h
2	13,2 km/h
3	25,3 km/h
4	36,2 km/h
Measured with tires	23.5 R25 L3
Front axle/rear axle	Volvo/AWB 31/30
Rear axle oscillation	±13°
Ground clearance at 13° osc.	460 mm

Brake system

Service brake: Volvo dual-circuit system with nitrogen charged accumulators. Outboard mounted hydraulically operated, fully sealed oil circulation cooled wet disc brakes. The operator can select automatic declutch of the transmission when braking through Contronic. Parking brake: Fully sealed, wet multi-disc brake built into the transmission. Applied by spring force and electro-hydraulically released with a switch on the instrument panel. Secondary brake: Dual brake circuits with rechargeable accumulators. Either one circuit or the parking brake fulfills all safety requirements. Standard: The brake system complies with the requirements of ISO 3450.

Number of brake discs per wheel front/rear	1/1
Accumulators	3x1,0 l
Accumulators for parking brake	1x1,0 l

Steering system

Steering system: Load-sensing hydrostatic articulated steering. System supply: The steering system has priority feed from a load-sensing axial piston pump with variable displacement. Steering cylinders: Two double-acting cylinders.

Steering cylinders	2
Cylinder bore	80 mm
Piston rod diameter	50 mm
Stroke	486 mm
Working pressure	21 MPa
Maximum flow	120 l/min
Maximum articulation	±40°

Cab

Instrumentation: All important information is centrally located in the operator's field of view on the Contronic monitoring system's display unit. Heater and defroster: Heater coil with filtered fresh air and fan with four speeds. Defroster vents for all window areas. Operator seat: Ergonomic seat with adjustable suspension and retractable seatbelt. The seat is mounted on a bracket, which is mounted on the rear cab wall. The forces from the retractable seat belt are absorbed by the seat rail. Standard: The cab structure is tested and approved according to ROPS (ISO 3471) and FOPS (ISO 3449). The cab meets all requirements according to ISO 6055 (Operator Overhead Protection - Industrial Trucks) and SAE J386 (Operator Restraint System).

Emergency exits	1
Sound level in cab according to ISO 6396	LpA 68 dB (A)
External sound level according to ISO 6395 (Directive 2000/14/EC)	LwA 106 dB (A)
Ventilation	9 m ³ /min
Heating capacity	11 kW
Air conditioning (optional)	8 kW

Hydraulic system

System supply: Two load-sensing axial piston pumps with variable displacement. The steering system always has priority. Valves: Double-acting 2-spool valve. The main valve is controlled by a 2-spool pilot valve. Lift function: The valve has four positions including raise, hold, lower and float. Inductive/magnetic automatic boom kickout can be switched on and off and is adjustable to any position between maximum reach and full lifting height. Tilt function: The valve has three functions including rollback, hold and dump. Inductive/magnetic automatic tilt can be adjusted to the desired bucket angle. Cylinders: Double-acting cylinders for all functions. Filter: Full flow filtration through 20 micron (absolute) filter cartridge.

Working pressure maximum, pump 1	21,0 MPa
Flow at and engine speed	145 l/min 10 MPa 32 r/s (1900 r/min)
Working pressure, pump 2	24,0 MPa
Flow at and engine speed	110 l/min 10 MPa 32 r/s (1900 r/min)
Pilot system Working pressure	3,5 MPa
Cycle times	
Raise*	5,4 s
Tilt*	2,1 s
Lower, empty	2,5 s
Total cycle time	10,0 s

* with load as per ISO 14397 and SAE J818

Lift arm system

Torque Parallel linkage (TP linkage) with high breakout torque and parallel action throughout the entire lifting range.

Lift cylinders	2
Cylinder bore	150 mm
Piston rod diameter	80 mm
Stroke	676 mm
Tilt cylinder	1
Cylinder bore	220 mm
Piston rod diameter	110 mm
Stroke	412 mm

Service

Service accessibility: Large, easy-to-open service doors with gas struts. Swing-out radiator grille and cooling fan. Possibility to log and analyze data to facilitate troubleshooting.

Refill capacities	
Fuel tank	215 l
Engine coolant	70 l
Hydraulic oil tank	143 l
Transmission oil	38 l
Engine oil	21 l
Axles front/rear	36/41 l

SPECIFICATIONS

Tires: 23.5 R25 L3

Standard boom	
B	6440 mm
C	3200 mm
D	440 mm
F	3360 mm
G	2130 mm
J	3710 mm
K	4030 mm
O	56 °
P _{max}	49 °
R	41 °
R ₁ *	45 °
S	66 °
T	92 mm
U	480 mm
X	2060 mm
Y	2680 mm
Z	3310 mm
a ₂	5730 mm
a ₃	3060 mm
a ₄	±40 °

* Carry position SAE

Where applicable, specifications and dimensions are in accordance with ISO 7131, SAE J732, ISO 7546, SAE J742, ISO 14397, SAE J818.

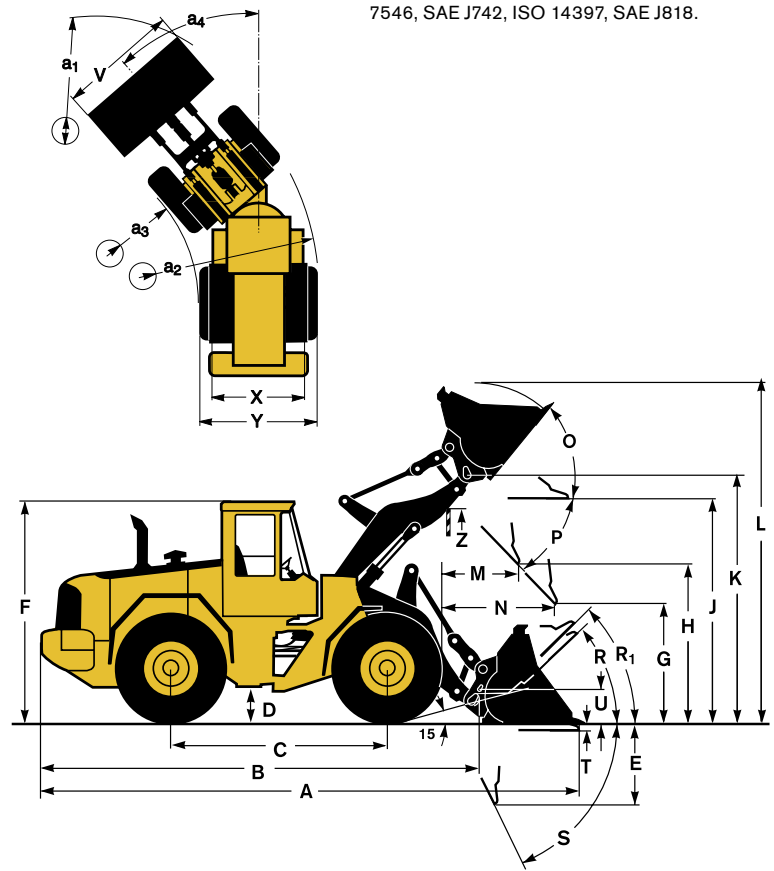

Tires: 750/65 R25





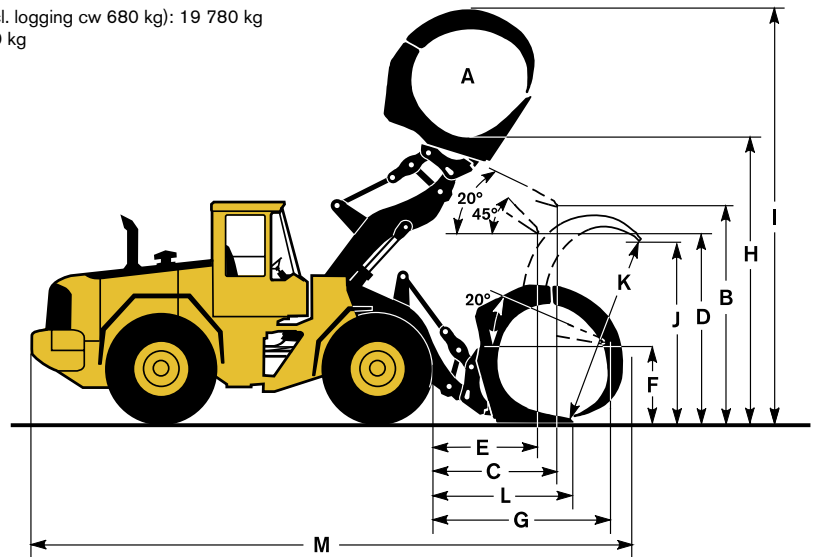





A	2,4 m ²
B	3480 mm
C	1850 mm
D	2860 mm
E	1460 mm
F	1530 mm
G	2720 mm
H	4600 mm
I	6640 mm
J	2790 mm
K	2990 mm
L	2050 mm
M	8720 mm

Operating weight (incl. logging cw 680 kg): 19 780 kg
Operating load: 6400 kg



Supplemental Operating Data

Tires 23.5 R25 L3		23.5 R25 L5	750/65 R25
Width over tires	mm	+30	+220
Ground clearance	mm	+40	+20
Tipping load, full turn	kg	+470	+350
Operating weight	kg	+680	+570

Tires 23.5 R25 L3	GENERAL PURPOSE							ROCK*	LIGHT MATERIAL		
											
	Teeth	Bolt-on edges	Teeth	Bolt-on edges	Bolt-on edges	Bolt-on edges	Bolt-on edges	Teeth & Segments	Bolt-on edges	Bolt-on edges	
Volume, heaped ISO/SAE	m ³	2,8	2,9	3,0	3,1	3,1	3,4	3,4	2,7	5,5	9,5
Volume at 110% fill factor	m ³	3,1	3,2	3,3	3,4	3,4	3,7	3,7	—	6,1	10,5
Static tipping load, straight	kg	13 220	12 190	12 400	12 980	12 230	12 090	12 900	12 550	11 400	11 490
at 35° turn	kg	11 800	10 840	11 030	11 580	10 870	10 730	11 490	11 140	10 070	10120
at full turn	kg	11 380	10 440	10 620	11 160	10 470	10 330	11 070	10 720	9670	9710
Breakout force	kN	166,0	143,8	146,2	156,3	138,6	132,5	153,2	127,2	104,7	91,3
A	mm	8050	7950	8220	7850	8010	8090	7880	8010	8480	8780
E	mm	1330	1250	1480	1150	1300	1360	1180	1310	1710	1970
H**)	mm	2740	2810	2630	2880	2810	2780	2860	2590	2410	2200
L	mm	5500	5560	5610	5490	5610	5670	5630	5510	5830	6000
M**)	mm	1260	1190	1380	1110	1190	1210	1130	1270	1520	1730
N**)	mm	1760	1730	1810	1690	1740	1760	1700	1910	1790	1800
V	mm	2880	2880	2880	3000	2880	2880	3000	2880	3000	3400
a ₁ clearance circle	mm	12 700	12 640	12 790	12 700	12 670	12 710	12 720	12 730	13 060	13 600
Operating weight	kg	18 020	18 360	18 340	18 110	18 400	18 470	18 240	18 530	18 810	19 030





*) With L5 tires

Note: This only applies to Volvo original attachments.

** Measured to the tip of the bucket teeth or bolt-on edge. Dump height to bucket edge. Measured at 45° dump angle. (Spade nose buckets at 42°.)

Bucket Selection Chart

The chosen bucket is determined by the density of the material and the expected bucket fill factor. The actual bucket volume is often larger than the rated capacity, due to the features of the TP linkage, including an open bucket design, good rollback angles in all positions and good bucket filling performance. The example represents a standard boom configuration.
Example: Sand and gravel. Fill factor ~ 105%. Density 1,65 t/m³. Result: The 3,1 m³ bucket carries 3,3 m³. For optimum stability always consult the bucket selection chart.

Material	Bucket fill, %		Material density, t/m ³	ISO/SAE bucket volume, m ³	Actual volume, m ³
Earth/Clay	~ 110		~ 1,80	2,9	~ 3,2
			~ 1,70	3,1	~ 3,4
			~ 1,50	3,4	~ 3,7
Sand/Gravel	~ 105		~ 1,75	2,9	~ 3,0
			~ 1,65	3,1	~ 3,3
			~ 1,50	3,4	~ 3,6
Aggregate	~ 100		~ 1,90	2,9	~ 2,9
			~ 1,70	3,1	~ 3,1
			~ 1,50	3,4	~ 3,4
Rock	≤100		~ 1,80	2,7	~ 2,7

The size of rock buckets is optimized for optimal penetration and filling capability rather than the density of the material.

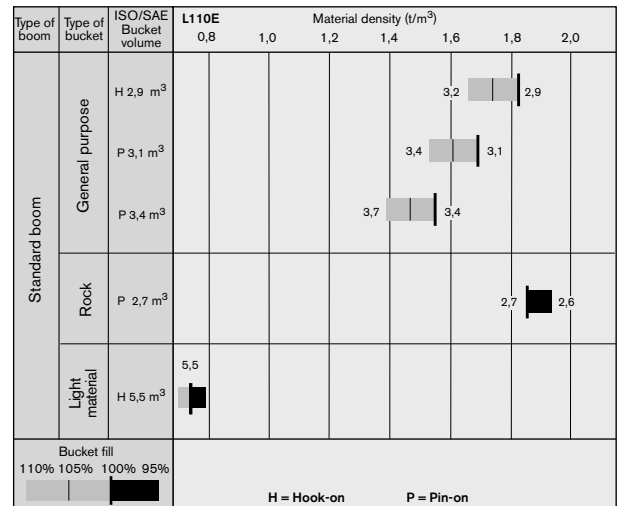

STANDARD EQUIPMENT

Engine

Three stage air cleaner with ejector and inner filter
Indicator glass for coolant level
Preheating of induction air
Muffler, spark arresting
Fuel filter, extra large with water trap
Fuel fill strainer
Coolant filter
Oil trap

Electrical system

24 V, prewired for optional accessories
Alternator, 24 V/55 A
Air filter for alternator
Battery disconnect switch
Fuel gauge
Hour meter
Electric horn
Reverse alarm
Instrument panel with symbols
Lighting:
• Twin halogen front headlights with high and low beams
• Parking lights
• Double brake and tail lights
• Turn signals with flashing hazard light function
• Halogen working lights (2 front and 2 rear)
• Instrument lighting

Contronic monitoring system

ECU with log and analysis system
Contronic display
Fuel consumption
Outdoor temperature
Engine shutdown to idle in case of malfunction indication:
• High engine coolant temperature
• Low engine oil pressure
• High transmission oil temperature
Start interlock when gear is engaged
Brake test
Test function for warning and indicator lights
Warning and indicator lights:
• Charging
• Oil pressure engine
• Oil pressure, transmission

- Brake pressure
- Parking brake
- Hydraulic oil level
- Axle oil temperature
- Primary steering
- Secondary steering
- High beams
- Turn signals
- Rotating beacon
- Preheating coil
- Differential lock
- Coolant temperature
- Transmission oil temperature
- Brake charging
- Level warnings:
 - Engine oil level
 - Coolant level
 - Transmission oil level
- Hydraulic oil level
- Washer fluid level

Drivetrain

Automatic Power Shift with operator-controlled declutch function for transmission cut-out when braking and mode selector with AUTO function
Fully automatic shifting gears 1-4
PWM-control between different gear positions
Forward and reverse switch by lever console
Differentials: front: 100% hydr. diff lock, rear: conventional

Brake system

Wet oil circulation cooled disc brakes on all four wheels, outboard mounted
Dual brake circuits
Dual service brake pedals
Secondary brake system
Parking brake, el-hydraulic
Brake wear indicator

Cab

ROPS (ISO 3471), FOPS (ISO 3449)
Single key kit door/start
Acoustic inner lining
Ashtray
Cigarette lighter

Lockable door
Cab heating with filter, fresh-air inlet and defroster
Floor mat
Interior light
Interior rear-view mirror
2 exterior rear-view mirrors
Openable window right-hand side
Tinted safety glass
Hip retractable seatbelt (SAE J386)
Adjustable lever console
Ergonomically designed operator's seat with adjustable suspension
Storage compartment
Sun visor
Beverage holder
Windshield washers front and rear
Windshield wipers front and rear
Interval function for front and rear windshield wipers
Service platforms with anti-slip surfaces on front and rear fenders
Speedometer

Hydraulic system

Main valve, 2-spool
Pilot valve, 2-spool
Variable displacement axial piston pumps (3) for:
• working hydraulics
• steering system, pilot hydraulics and brakes
• fan motor
Boom lowering system
Boom kickout, automatic, adjustable
Bucket positioner, automatic with position indicator, adjustable
Hydraulic oil cooler

External equipment

Noise and vibration dampening suspension of cab, engine and transmission
Lifting lugs
Easy-to-open side panels
Frame steering, joint lock
Vandalism lock prepared for batteries and engine compartment
Towing hitch
Guardrails, on rear mudguards

OPTIONAL EQUIPMENT

(Standard on certain markets)

Service and maintenance

Tool box, lockable
Tool kit
Automatic lubrication system
Automatic lubrication system for attachment bracket, cast
Automatic lubrication system for attachment bracket, welded
Refill pump for automatic lubrication system
Wheel nut wrench kit
Oil sampling valve

Engine equipment

Engine block heater, 230 V
Air pre-cleaner, oil bath type
Air pre-cleaner, turbo type
Air pre-cleaner, Sy-Klone type
Hand throttle control
Radiator, hydraulic oil cooler and fuel cooler, corrosion protected
Fan air intake protection
Reversible cooling fan
Reversible cooling fan (in comb. with axle oil cooler)

Electrical system

Alternator, 80 A
Battery boxes, steel
Battery disconnect switch, additional in cab
Working light, attachments
Working lights front, extra
Working lights rear, extra
Working lights front, on cab, dual
Working lights front, high intensity
License plate holder, lighting
Assymetrical lights for left-hand traffic
Reverse lights
Shortened headlight support brackets
Warning beacon, rotating, collapsible
Side marker lamps

Cab

Installation kit for radio
Radio with tape recorder
Radio with CD-player
Sun blinds, front and rear windows
Sun blinds, side windows
Sliding window, right
Sliding window, door

Retractable hipbelt, longer and wider than standard
Air conditioning
Air conditioning with corrosion protected condenser
Air conditioning with automatic temp. control (ATC)
Air conditioning with corrosion prot. condenser and automatic temp. control (ATC)
Ventilation air filter for work in asbestos environment
Operator's seat with low backrest
Operator's seat with low backrest and electrical heating
Operator's seat with high backrest and electrical heating
Operator's seat air suspended with high backrest and electrical heating
Instructor's seat
Armrest (left) for operator's seat
Lunchbox holder
Adjustable steering wheel
Steering wheel knob
Noise reduction kit
Rear view camera incl. monitor
Rear view mirrors, el. heated

Drivetrain

Limited slip rear
Speed limiter 20 km/h
Speed limiter 30 km/h
Wheel/axle seal guards

Brake system

Parking brake alarm, audible
Oil cooler and filter for front and rear axles
Oil cooler and filter for front and rear axles in combination with reversible fan

Hydraulic system

Single lever control
Single lever control for 3rd hydraulic function
3rd hydraulic function
3rd-4th hydraulic function
Detent for 3rd hydraulic function
Boom Suspension System
Single acting lifting function
Biodegradable hydraulic fluid
Attachment bracket, cast
Attachment bracket, welded
Arctic kit, attachment locking hoses
Arctic kit, pilot hoses and brake accum.
Separate attachment locking
Return-to-dig

External equipment

Mudguards
Mudguards, full coverage rear
Mudguards, full coverage front/rear
Mudflap kit for mudguards
Deleted front mudguards and rear wideners
Logging counterweight

Protective equipment

Guards for front headlights
Guards for taillights
Guards for taillights, heavy-duty
Guards for side and rear windows
Guard for radiator grille
Windshield guard
Bellyguard front
Bellyguard rear
Cover plate for front frame, heavy-duty
Cover plate, under cab
Cover plates, rear frame
Guards for grease nipple
Guards for center hinge and rear frame
Guards for boom cylinder hose and tube
Corrosion protection, painting of machine
Corrosion protection, painting of attachment bracket
Bucket teeth protection

Other equipment

Comfort Drive Control, CDC
Secondary steering
Sign, slow moving vehicle
Noise reduction kit, EU
Sign 50 km/h
CE-marking
Sound decal EU

Tires

23.5 R25
750/65 R25

Attachments

Buckets:
• Straight with/without teeth
• Spade nose with/without teeth
• High tipping
• Light materials
Bolt-on and weld-on bucket teeth
Cutting edge in three sections, bolt-on
Bucket spill guard
Fork equipment
Material handling arm
Log grapples



Boom Suspension System (BSS)*
 BSS utilizes gas/oil accumulators connected to the lift cylinders to absorb shocks and smooth out rough roads for faster cycle times, less spillage and increased operator comfort.



Automatic Lubrication System*

Our factory fitted Automatic Lubrication System takes care of greasing while the machine is in operation. This means less downtime for scheduled maintenance and more time for productive work.



Comfort Drive Control (CDC)*

CDC significantly reduces repetitive and tiring steering wheel movements. The operator can shift and steer easily with the aid of controls integrated in the left armrest.



3rd and 4th hydraulic functions*

Volvo wheel loaders can be equipped with third and fourth hydraulic functions, which are operated with additional control levers. These functions are necessary when there's a need to operate a third and fourth hydraulic function at the same time, such as when using a sweeper attachment or a timber grapple with hydraulic heel kick-out.

Genuine Volvo attachments

Genuine Volvo attachments and wear parts, including the new Volvo Tooth System, are designed as an integral part of the loader, making the L110E a swift and versatile machine in a wide range of applications.

* Optional





Volvo Construction Equipment is different. It's designed, built and supported in a different way. That difference comes from an engineering heritage of over 170 years. A heritage of thinking first about the people who actually use the machines. About how to help them be safer, more comfortable, more productive. About the environment we all share. The result of that thinking is a growing range of machines and a global support network dedicated to helping you do more. People around the world are proud to use Volvo. And we're proud of what makes Volvo different – **More care. Built in.**



All products are not available in all markets. Under our policy of continuous improvement, we reserve the right to change specifications and design without prior notice. The illustrations do not necessarily show the standard version of the machine.

VOLVO

Construction Equipment
www.volvo.com

Ref. No. 21 A 100 1563
Printed in Sweden 2005.05-2,0
Volvo, Eskilstuna

English
WLO