

B20D 6x4 **ARTICULATED DUMP TRUCK MK VII**



Gross Power: 170 kw (228 hp)
Gross Torque: 810 Nm (597 lbft)
Rated Payload: 18 000 kg

B20D 6x4 ARTICULATED DUMP TRUCK MKVII

ENGINE	Mercedes Benz OM906LA
Configuration	I-6 with exhaust brake and Engine Valve Brake (EVB)
Aspiration	Turbocharged and intercooled
Cooling system	Single pass radiator & charge air cooler
Gross power	170 kW (228 hp) @ 2,200 rpm SAE J1349
Net Power	165 kW (221 hp) @ 2,200 rpm
Gross torque	810 Nm (597 lbft) @ 1,050 -1,850 rpm SAE J1349
Net torque	780 Nm (575 lbft) @ 1,050 -1,850 rpm
Displacement	6,37 litres (389 cu.in)
Fuel tank capacity	200 l (58 US gal)

TRANSMISSION	Allison 3000P ORS (with optional retarder)
Layout	Engine mounted box with rear output
Gear layout	Constant meshing planetary gears
Clutch type	Hydraulically operated multidisc
Torque converter layout	Hydrodynamic, with lock-up in all gears

TRANSFER BOX	VGR 13 100
Output differential	Interaxle 50/50 proportional differential, pneumatically lockable whilst stationary or on the move.

AXLES	Bell 14T
Differential type	Spiral bevel type with Limited Slip
Final drive type	Outboard heavy duty planetary
Housing type	Steel fabricated

BRAKING SYSTEM	
SERVICE BRAKE	Dual circuit, full hydraulic actuation caliper brakes on all wheels
Maximum brake force	164 kN (36,900 lbf)
PARK & EMERGENCY	Spring applied, air released driveline mounted disc.
Maximum brake force	396 kN (89,000 lbf)
AUXILIARY BRAKE	Automatic exhaust brake and Engine Valve Brake (EVB)
Maximum retardation	442 kW (593 hp)

WHEELS	
Tyre: Size	20,5R25
Type	Radial Earthmover
Maximum ground pressure (laden)	134 kPa (19 psi)



SUSPENSION SYSTEM	
Front: Type	Semi-independent leading arm type linkages supported by nitrogen/oil struts
Rear: Type	Pivoting walking beams equalize the load on each axle with laminated suspension blocks. Each axle is coupled to the chassis by a system of four rubber-bushed links for ideal vertical movement.

HYDRAULIC SYSTEM	Variable displacement with load sensing system. A ground-driven, load sensing emergency steering pump is integrated into the main system
Flow	184 l/min (48.6 US gal/min)
Pressure	25 MPa (3,915 psi)
Filter	10 micron

PNEUMATIC SYSTEM	Air drier with heater and integral unloader valve, serving park brake and auxiliary functions
System pressure	850 kPa (123 psi)

DUMPING SYSTEM	
Raise time	12 s
Power down time	6,0 s
Tipping angle	70°

ELECTRICAL SYSTEM	
Voltage	24 V
Battery Type	Two maintenance free permanently sealed
Battery capacity	2 x 105 Ah (optional 2 extra batteries)
Alternator rating	28 V 80 A

STEERING SYSTEM	Hydrostatically actuated by two double acting cylinders, with ground-driven emergency steering pump.
Angle	+ - 45 degrees
Lock to lock turns	4,1

VEHICLE SPEEDS	km/h	mph
1st	8	5
2nd	13	8
3rd	22	13.7
4th	31	19.3
5th	45	28
6th	50	31
R	9	5.6



B20D 6x4 ARTICULATED DUMPTRUCK MkVII

LOAD CAPACITY & GROUND PRESSURE

WEIGHTS			GROUND PRESSURE			LOAD CAPACITY		
UNLADEN	kg	lbs	LADEN	kPa	psi	BODY	m ³	cu.yd
Front	7,520	16,578	Front	207	30	Struck Capacity	8,5	11,1
Middle	3,520	7,760	Middle	293	42	SAE 2:1 Heaped	11	14,4
Rear	3,250	7,165	Rear	291	42	SAE 1:1	13,6	17,8
Total	14,290	31,504				SAE 2:1 Capacity with Autogate	N/A	N/A
LADEN						Rated Payload	18 000 kg	35,683 lbs
Front	8,402	18,523						
Middle	12,079	26,630						
Rear	11,809	26,034						
Total	32,290	71,187						

GRADEABILITY/RIMPULL

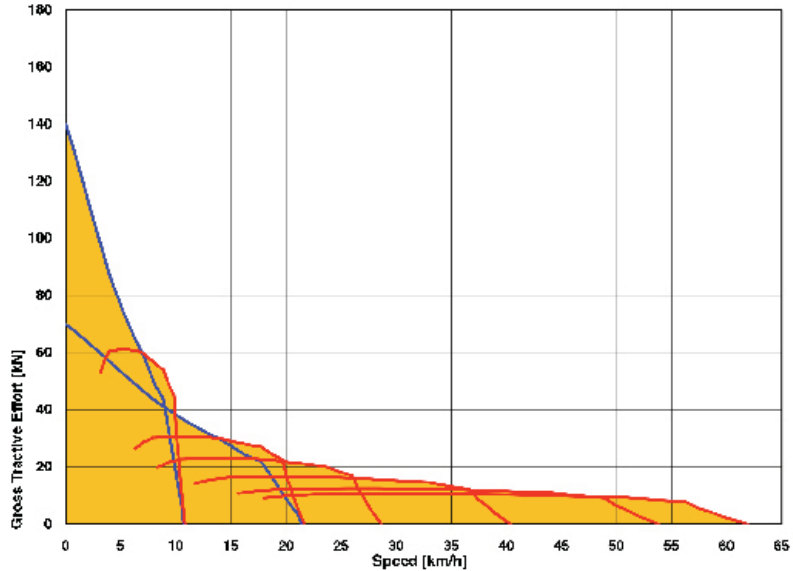
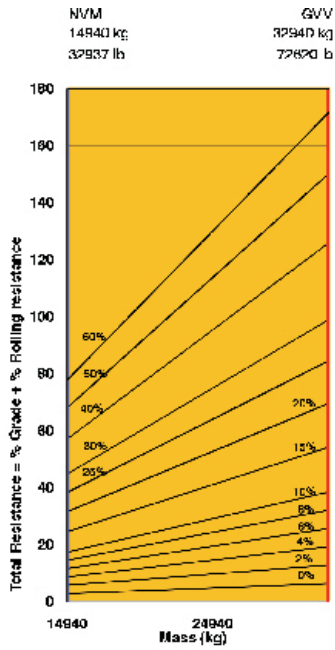

RETARDATION

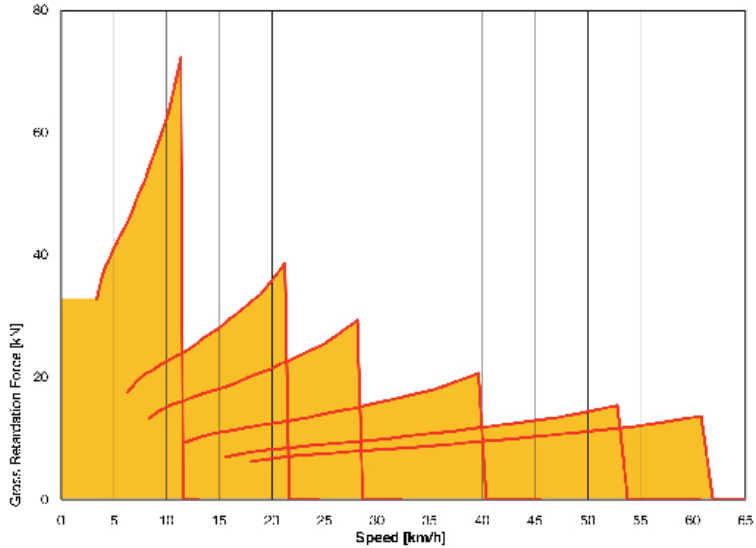
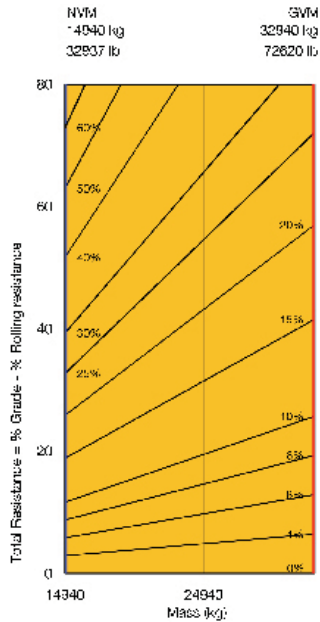

B20D 6x4 ARTICULATED DUMP TRUCK MKVII

DIMENSIONS

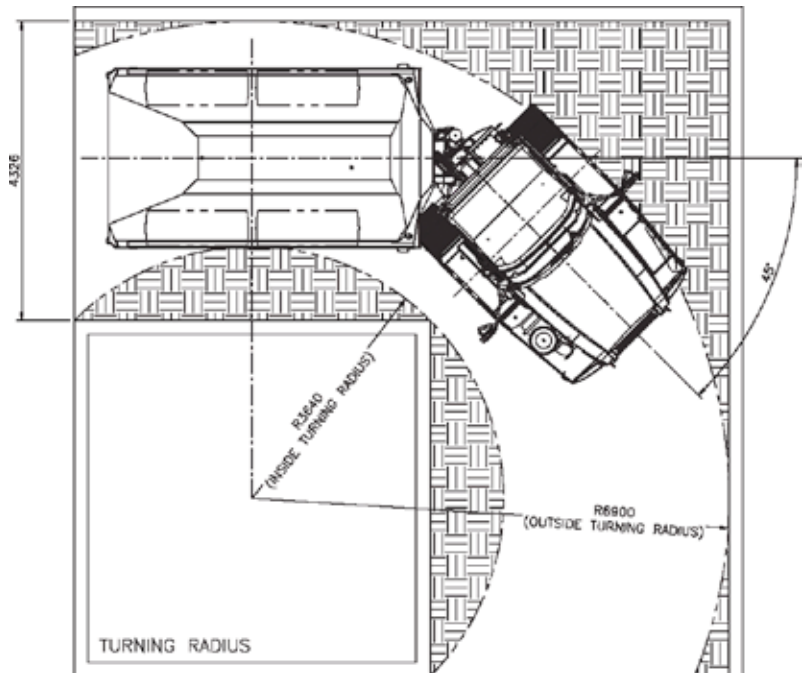
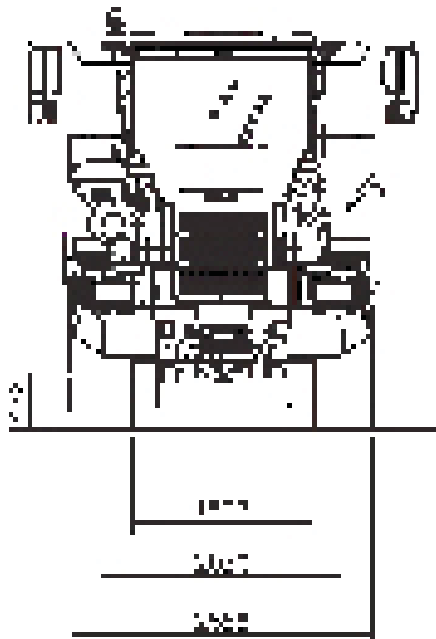
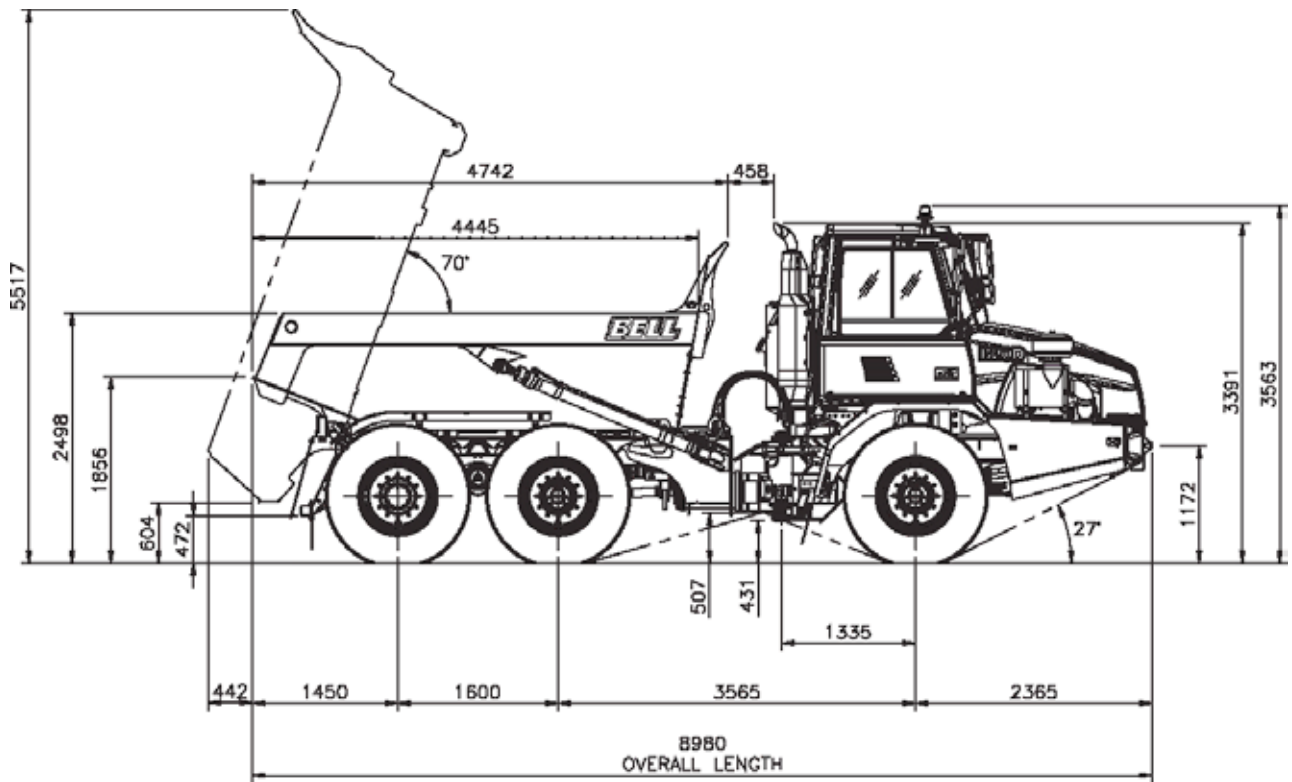

B20D 6x4 ARTICULATED DUMP TRUCK MkVII

AVAILABLE EQUIPMENT*

Cab

- ROPS/FOPS certification
- Protective rear window guard
- Tilt cab for service access
- Gas strut supported door
- Tinted safety glass
- Sliding windows
- Rear view mirrors - regular and wide angle
- Sun visor
- Wiper/washer with intermittent control
- Tilt and telescoping steering wheel
- Adjustable, air suspension seat with retractable seat belt
- Fold-away trainer seat with retractable seat belt
- HVAC climate control system with filtered and ducted air
- Rotating beacon
- 12 V power outlet/12 V cigarette lighter
- Ash tray
- Drinks holder
- Cooled/heated lunch box
- I-Tip programmable bin tip
- Sound insulated to 76 dB(A) to ISO 6396
- Radio/CD/Tape
- Memory Module
- Air horn

MDU Features

- Operator / Site selected speed control
- Tipping counter
- Trip timer
- Trip distance
- Transmission gear selection
- Fuel Consumption
- Diagnostics
- Intermittent wiper timing control
- Speedo calibration for alternative tyre sizes
- Metric /Imperial unit selection
- Warning lights with audible buzzer

Gauges

- Engine coolant temperature
- Engine oil pressure
- Transmission oil temperature
- Fuel
- Tachometer
- Battery voltage
- Hourmeter
- Odometer
- System air pressure

Vehicle

- Ground driven emergency steering
- Bin safety prop
- Articulation lock
- Integral transmission output retarder with 6 settings (optional)

Other

- (Factory or field installed)
- On Board Weigh System (OBW)
 - Electrically adjustable rearview mirrors - one per side
 - Groeneveld auto greasing system
 - Retractable sun visor
 - Exhaust body heating
 - Autogate
 - Body liners
 - Fleetmatic Satellite Monitoring System
 - Driver ID and immobiliser
 - Forward working lights
 - Artic reverse light
 - Fuel heater
 - External windshield visor
 - Headlight protection grills
 - Rear window wiper
 - Antenna mounting bracket
 - System for reverse camera
 - Wiggins quick fuelling system
 - Tyre pressure monitoring

*standard specification for machines may vary according to region



B20D 6x4 ARTICULATED DUMP TRUCK Mk VII

- The exclusive on-board weighing option presents the operator with real time information on the payload while the machine is being loaded. A 'limp home' mode can also be activated if the machine is significantly over-loaded.



- The park brake automatically applies when neutral is selected and it is not possible to engage neutral at speed. Torque dependent park brake release (hill assist) ensures no roll back on slopes.



- The incorporation of a Pitch and Roll sensor in the vehicle allows the bin to not be operated if the truck is in an unsafe position.



- Full hand-rails kit can be installed to provide even more safety when performing engine checks.



- Keyless start, driver identity, and access codes ensures no unauthorized operation of your equipment.



- Both operator or site selectable maximum speed control allows the vehicle to automatically de-accelerate and apply the retarder to prevent onsite speeding.



- Reverse cameras are available for factory or on site fitment ensuring full view when reversing.



- Optional Tyre pressure - monitoring System ensures that the operator has real time information on all tyres pressure and temperature conditions.



- The best in class retarder and engine braking automatically applies when the operator lifts his foot off the accelerator. Retarder aggressiveness can be simply adjusted on the sealed switch module ensuring maximum descent control for all conditions.

- All trucks can be set up to automatically sound the horn when starting or switching between forward and reverse.

BELL INTERNATIONAL: Tel: +27 (0) 35-907 9431

 Tel: +33 (0) 5 55 89 23 56

 Tel: +49 (0) 6631 / 91 13 - 0

 Tel: +34 91 879 60 19

 Tel: +27 (0) 11-928-9700

 Tel: +44 (0) 1283 712862

E-mail: sales@bellequipment.com • www.bellequipment.com

All dimensions are shown in millimetres, unless otherwise stated between brackets. Under our policy of continuous improvement, we reserve the right to change specifications and design without prior notice. Photographs featured in this brochure may include optional equipment.

**Strong Reliable Machines
Strong Reliable Support**

BELL