

# ATTACHMENTS

FOR VOLVO BM LOADERS





# VOLVO BM GENUINE ATTACHMENTS

As a loader manufacturer, Volvo BM long ago realised the importance of machine flexibility including fast adaptation to different tasks. The machine and its handling attachment must form a unit that offers maximum capacity and thereby optimum economy in every working situation.

Bucket work is a primary function, but a loader must be capable of performing numerous other duties as well, handling logs, sawn wood and palletized goods, snow clearance and building site work, for example.

Volvo BM's highly skilled development and production engineers have systematically designed lines of attachments ideally suited to the machine and to specific tasks. Every Volvo BM loader is supported by a first-rate, modern and functional range of attachments developed through scientific studies and years of experience. ***This means that you can always choose the best attachment for your particular needs.***



## MACHINE/LIFT- ARMS/ATTACHMENT: – ONE UNIT

- The loader unit has been designed with the aid of computers for use with Volvo BM attachments, giving optimum bucket angles and breakout forces. If this geometry is altered because an unapproved bucket is used, the machine's capacity can be drastically reduced.
- High lift-arm mounting and long reach give a high working level. The clearance achieved enables working across trucks and railway cars without fouling the side arms, as would be the case with many other makes.
- Maximum visibility together with geometric efficiency and strength have been achieved by computer-assisted design of the loader unit.
- The lift-arm system and its bearings distribute the load evenly, eliminating flexural stresses and unnecessary wear.
- Buckets and attachments are light, yet immensely strong to maintain their high overall capacity. Volvo BM attachments are made of high-quality materials and are ideally matched to the power resources of the machine.
- All of these factors must interact perfectly. Only then do you get optimum capacity and economy. *Machine/lift-arms/attachment: one unit.*

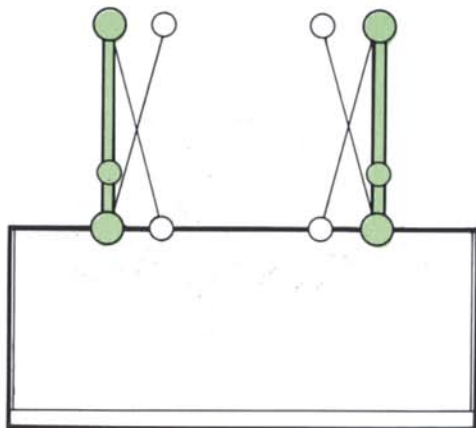



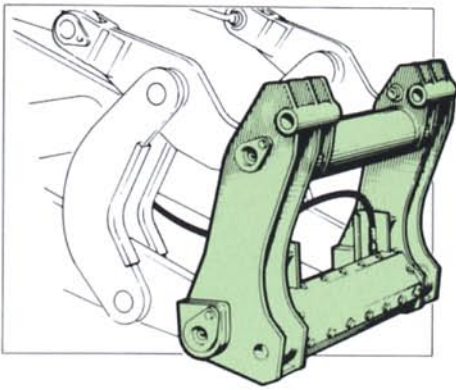

# ATTACHMENT BRACKET

The new Volvo BM attachment bracket with snap-on coupling is both rugged and convenient. A precision fit and a practical design with large, rounded hooks facilitates guiding the attachment into the bracket. The attachment is then locked by a built-in double acting hydraulic cylinder. Indicator arrows show when the attachment is locked — a convenient safety feature.

**Because changing attachments is so easy with the Volvo BM attachment bracket, operators don't hesitate to change attachments when they need to. The result: improved machine utilization.**

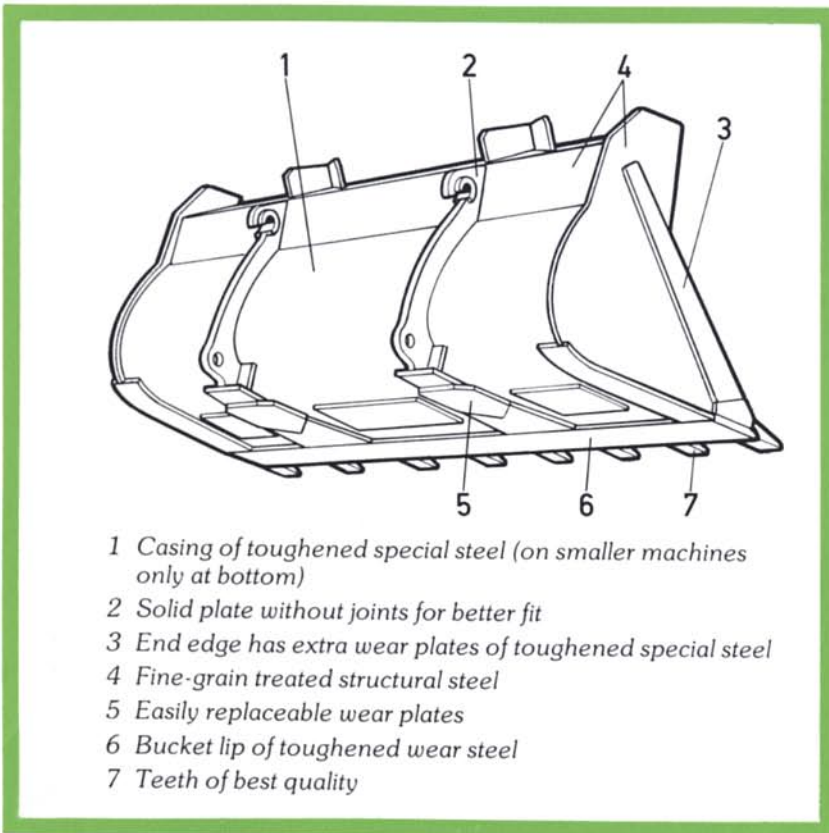
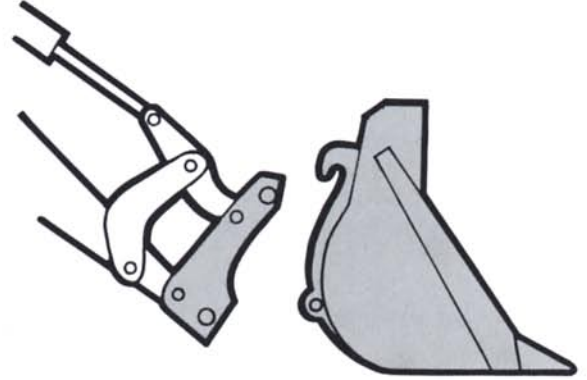

- 1 Casing of toughened special steel (on smaller machines only at bottom)
- 2 Solid plate without joints for better fit
- 3 End edge has extra wear plates of toughened special steel
- 4 Fine-grain treated structural steel
- 5 Easily replaceable wear plates
- 6 Bucket lip of toughened wear steel
- 7 Teeth of best quality

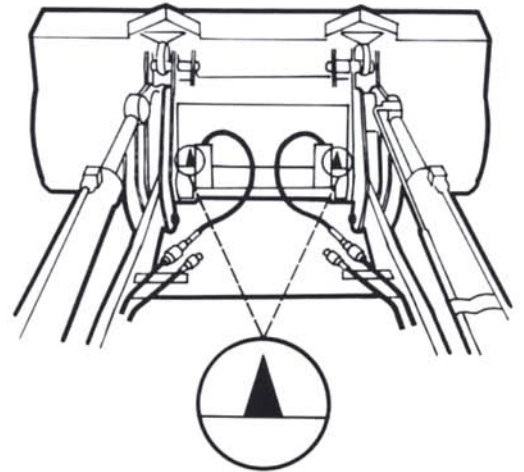

## MATERIAL QUALITY

If an attachment is going to work efficiently, the quality of design and particularly materials must match that of the loader. The severity of the Scandinavian climate together with the rocky terrain, imposes harsh working conditions on all construction and handling machinery. That is why Volvo BM can only afford to use the very highest-grade materials and workmanship available. To you, this means long life and good economy.

## QUALITY WORKMANSHIP

The attachments are made in superbly-equipped workshops. Only minute tolerances are acceptable to ensure a perfect fit. A high quality lift-arm system demands a high quality attachment. This is achieved by means of stringent quality control, advanced welding techniques and sophisticated machining, including boring.

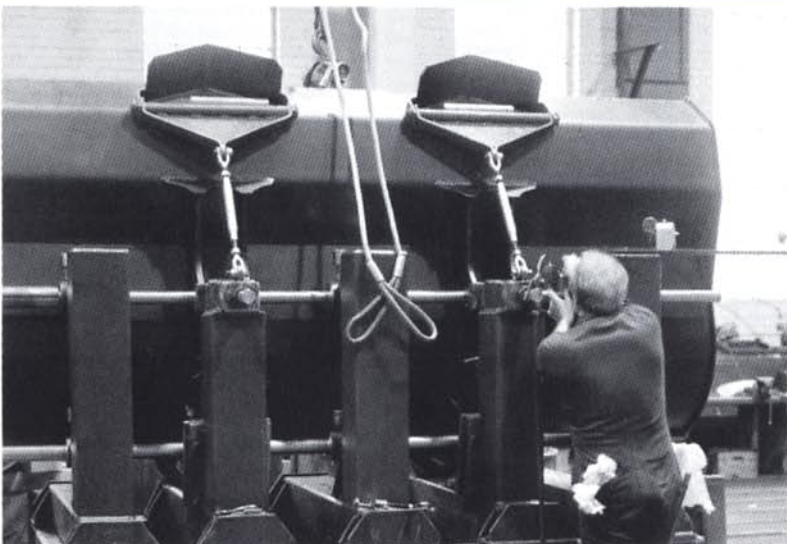

# SELECTING BUCKETS

The choice of bucket is determined primarily by the type and density of material to be handled. If you are in doubt about the size of bucket to use on any particular job, choose a smaller one. It will give you better penetration, faster and more efficient bucket filling and probably an increase in overall machine capacity.

Hard, stony material is best handled with a toothed bucket. And vice versa: soft material is best handled with a bucket that has a straight lip without teeth. The particular bucket combination you choose will depend on personal experience and the bucket's use.

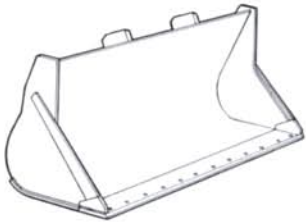

*Straight bucket without teeth. Suitable for soft material, sand, soil, fertilizer.*



*Straight bucket with teeth. Suitable for hard material, gravel, clay, excavation work.*

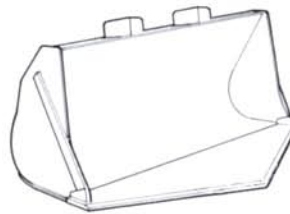

*V-lip without teeth. Suitable for hard material, gravel, finely-blasted rubble and ore.*



*Truncated V-lip with teeth. Suitable for hard and stony material, hard gravel and blasted rock.*

## SPILL PLATE

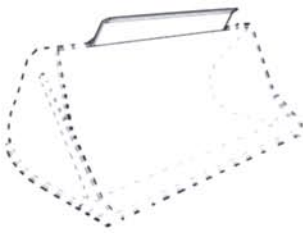

*Prevents material from spilling over the rear edge of the bucket when the bucket is tilted back. Can be mounted on bucket equipped with tilt cylinder guard. The spill plate with fasteners is supplied only for installation by the customer.*

4300B	4400	4500	4600 B
99173	99174	99174	99175

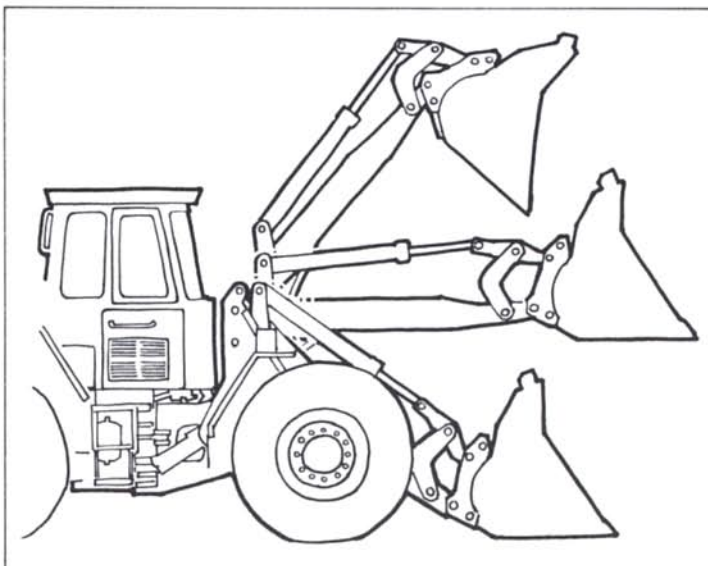

Volvo BM's new lift-arm system provides good breakout forces, throughout the full range of movements, together with good bucket angles. This results from a unique link-arm design which ensures that there is always good leverage angles through the full tilt movement.







*With the right attachment, the capabilities of the machine can be fully exploited. This results in high work capacity and operating economy.*

# RELIABILITY

SKOPA/BUCKET	
ARTIKEL/PART	NO. <input type="text"/>
TILLV./MANUF.	NO. <input type="text"/>
VOLYM/VOLUME	<input type="text"/> m <sup>3</sup> SAE
LAST/LOAD	<input type="text"/> ton
MAX. TRYCK/PRESSURE	<input type="text"/> MPa
VIKT/WEIGHT	<input type="text"/> kg
SKÄR/EDGE	NO. <input type="text"/>
SPARSKÄR/EDGE SAVER	NO. <input type="text"/>
TAND/TOOTH	NO. <input type="text"/>
HOLK/ADAPTER	NO. <input type="text"/>

**VOLVO BM**  
SWEDEN

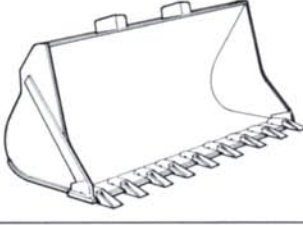
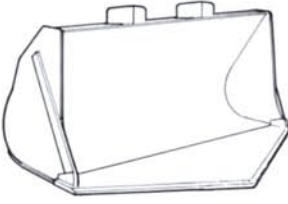
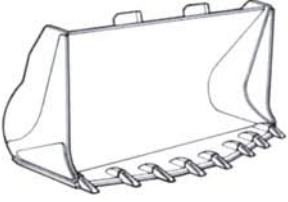
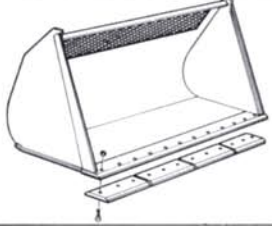
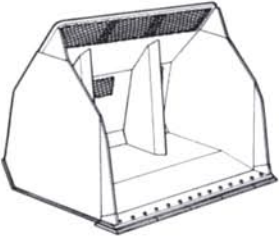
Volvo BM attachments are tested and approved for quality and function. The product data plate gives the attachment's type number, weight, grip area, volume and max. load on the machine in question. The plate identifies the attachment as a genuine Volvo BM product.

		Capacity weight		Mounting R* D**	622/642		
		t/m <sup>3</sup>	lb/yd <sup>3</sup>		Capacity		Order No.
		m <sup>3</sup>	yd <sup>3</sup>				
	<b>STRAIGHT LIP WITHOUT TEETH</b> <b>(sand, gravel, soil, clay)</b> The bucket is designed for loading material which can be broken loose from the bank with relative ease. Available with edge saver.	1.8	3000	R	1.0	1.3	98475
		1.6	2700	D	—	—	—
		1.5	2500	R	1.3	1.7	97859
	<b>STRAIGHT LIP WITH TEETH</b> <b>(sand, gravel, soil, clay)</b> The bucket is designed for loading materials which require high penetration and breakout forces.	1.8	3000	R	1.0	1.3	98476
		1.6	2700	D	—	—	—
		1.3	2700	R	1.3	1.7	97860
	<b>V-LIP WITHOUT TEETH</b> <b>(gravel, finely-blasted rubble)</b> The bucket is designed for loading materials which require very high penetration and breakout forces.	1.8	3000	R	1.15	1.5	99838
				D	—	—	—
	<b>TRUNCATED V-LIP WITH TEETH</b> <b>(hard gravel, blasted rock)</b> The bucket is designed for loading materials which require very high penetration and breakout forces. The bucket has low-cut sides to aid penetration into the material.	1.8	3000	R	1.0	1.3	98479
				D	—	—	—
	<b>LIGHT MATERIALS BUCKET</b> <b>(wood chips, coke, snow etc.)</b> The bucket is designed for handling materials of low density. Available with edge saver.	0.8—1.0	1350—1700	R	2.1	2.75	98611
		0.7	1180	R	—	—	—
		0.5	850	R	—	—	—
	<b>HIGH-DUMP LIGHT MATERIALS BUCKET</b> <b>(wood chips, coke etc.)</b> The bucket is designed for handling materials of low density. Since it can be dumped over a special frame, an unloading height of 4.2 m can be reached. Fitted with edge saver.	0.8—1.0	1350—1700	R	1.6	2.1	98612
		0.5	1180	R	2.8	3.7	98605
		0.4	675	R	3.5	4.6	97939
	<b>GRADING BUCKET</b> This bucket is intended for earthmoving work, such as overburden removal, small-scale dozing and excavation work, landscaping and levelling infill.	1.3—1.5	2190—2530	R	1.6	2.1	98609
	<b>SAND SPREADING BUCKET</b> Intended for spreading sand, gravel, wood chips, salt, urea, etc. Adjustment of the spreading rate is effected by means of a hydraulic control valve. The bucket can also be used for snow loading.	Epoke Order No.		R	2.0	2.6	3401-4



4200 B cassette			4200 B			4300 B			4400			4500			4600 B		
Capacity m <sup>3</sup>	Capacity yd <sup>3</sup>	Order No.	Capacity m <sup>3</sup>	Capacity yd <sup>3</sup>	Order No.	Capacity m <sup>3</sup>	Capacity yd <sup>3</sup>	Order No.	Capacity m <sup>3</sup>	Capacity yd <sup>3</sup>	Order No.	Capacity m <sup>3</sup>	Capacity yd <sup>3</sup>	Order No.	Capacity m <sup>3</sup>	Capacity yd <sup>3</sup>	Order No.
1.0	1.3	97989	1.15	1.5	90039	1.5	2.0	90041	1.9	2.5	97992	2.4	3.1	98281	3.8	5.0	98933
—	—	—	—	—	—	—	—	—	1.9	2.5	97996	2.4	3.1	98282	3.8	5.0	99026
—	—	—	1.25	1.6	99776	1.65	2.2	99784	2.1	2.75	99148	—	—	—	—	—	—
—	—	—	—	—	—	—	—	—	2.1	2.75	99149	2.6	3.4	99152	4.2	5.5	99203
1.15	1.5	90039	1.4	1.8	99778	1.8	2.35	99786	2.3	3.0	97994	2.9	3.8	98433	4.5	6.0	99028
—	—	—	—	—	—	—	—	—	2.3	3.0	97998	2.9	3.8	98435	4.5	6.0	99027
1.0	1.3	97988	1.15	1.5	90040	1.5	2.0	90042	1.9	2.5	97993	2.4	3.1	98279	3.8	5.0	98936
—	—	—	1.15	1.5	90252	1.5	2.0	90043	1.9	2.5	97997	2.4	3.1	98280	3.8	5.0	98932
—	—	—	1.25	1.6	99777	1.65	2.2	99785	2.1	2.75	99150	—	—	—	—	—	—
—	—	—	1.25	1.6	90250	1.65	2.2	99781	2.1	2.75	91151	2.6	3.4	99153	4.2	5.5	99202
—	—	—	1.15	1.5	99838	1.5	2.0	99841	1.9	2.5	98031	2.4	3.1	98283	—	—	—
—	—	—	—	—	—	—	—	—	1.9	2.5	98029	2.4	3.1	98284	3.8	5.0	99023
—	—	—	—	—	—	1.5	2.0	99839	1.9	2.5	98032 <sup>1)</sup>	—	—	—	—	—	—
—	—	—	—	—	—	—	—	—	1.9	2.5	98030 <sup>1)</sup>	2.4	3.1	98286	3.8	5.0	98934
									<sup>1)</sup> with 3 teeth								
1.8	2.35	97985	2.1	2.75	98611	3.0	3.9	99555	3.6	4.7	98432	4.6	6.0	98437	7.0	9.2	99172
2.1	2.75	98611	2.5	3.25	98018	3.6	4.7	98432	—	—	—	—	—	—	—	—	—
—	—	—	—	—	—	—	—	—	—	—	—	9.0	11.7	99435	13.0	17.0	99358
—	—	—	1.6	2.1	98612	2.2	2.9	99788	3.1	4.0	99179	4.0	5.2	99250	—	—	—
2.0	2.6	97968	3.0	3.9	98605	4.3	5.6	99795	6.5	8.5	98643	8.0	10.5	99096	—	—	—
—	—	—	—	—	—	—	—	—	—	—	—	—	—	—	—	—	—
1.1	1.4	97990	1.6	2.1	98609	1.6	2.1	98609	—	—	—	—	—	—	—	—	—
—	—	—	2.0	2.6	3401-4	2.0	2.6	3401-4	—	—	—	—	—	—	—	—	—

**For further information, contact your Volvo BM representative.**

# SELECTING A LOG GRAPPLE

One of the fundamental principles in choosing a log grapple for roundwood handling is that, the longer the log, the smaller the grapple area and the wider the grapple should be. The width of the grapple is often determined by the distance between the stakes on the timber vehicle or the width of the sorting bin. The log grapples are designed differently to cater for every machine application.

## DIFFERENT TYPES OF GRAPPLES

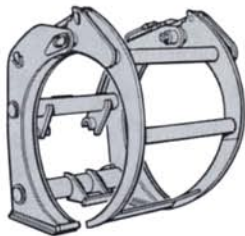

The unloading grapple has short tines, making it easier to fill the grapple when unloading a timber vehicle. Long, straight tines would in this case damage the timber.

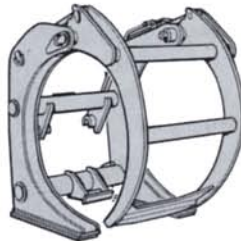

The sorting grapple has relatively long and straight bottom tines, which can slide along the ground under the timber stack to fill the grapple to capacity.

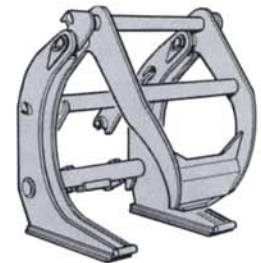

The whole-stem grapple is a wide grapple that can grip single trunks as well.

### All grapples require 3:rd hydraulic control

Kick-out/heel is available for some of the log grapples, especially the sorting grapples. The heel function is used, for example, to hold one log in a large grapple. The kick-out function is used to top up high stacks, where the grapple cannot be tilted. Instead, the log is pushed out, providing a half metre higher reach.

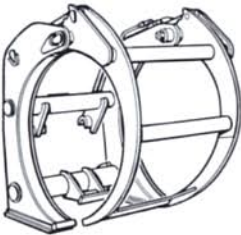
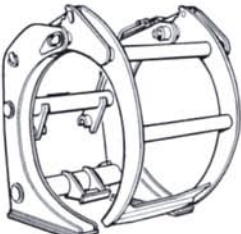
	Timber/pulpwood length		Mounting R* D**	622/642 Area		Order No.	4200 B cassette
	m	ft		m <sup>2</sup>	ft <sup>2</sup>		
 <p><b>UNLOADING GRAPPLE</b> For unloading timber from e.g. trucks for stacking. The grapple has short tines and a clamp with link that gives the grapple a large grip opening area. The short tines permit efficient and gentle unloading. The grapple cannot be equipped with heel/kickout.</p>	3	10	R	—	—	—	—
	4.5	15	R	—	—	—	—
 <p><b>SORTING GRAPPLE (timber)</b> For feeding sorting plants from a stack. It has relatively long fork tines to reach into bunkers. The clamp is equipped with a link that gives the grapple a large grip opening area and can be equipped with hydraulic heel/kick-out.</p>	3	10	R	1.2	13	90257	—
	4.5	15	R	0.8	9	99323*	—

\*R = Snap-on coupling    \*\*D = Bolt-on attachment





Long reach and good lifting height are an asset for loading or unloading timber vehicles. These features enable the work to be carried out quickly and surely. The excellent breakout forces, even in the top position, permit superb handling of roundwood.

4200 B			4300 B			4400			4500			4600 B		
Area	Order		Area	Order		Area	Order		Area	Order		Area	Order	
m <sup>2</sup>	ft <sup>2</sup>	No.	m <sup>2</sup>	ft <sup>2</sup>	No.	m <sup>2</sup>	ft <sup>2</sup>	No.	m <sup>2</sup>	ft <sup>2</sup>	No.	m <sup>2</sup>	ft <sup>2</sup>	No.
—	—	—	—	—	—	1.7	18	99350	2.2	25	99353	4.1	44	99133 <sup>a</sup>
—	—	—	1.2	13	98418	1.4	15	99109	1.7	18	99350	3.1	33	99745 <sup>b</sup>
—	—	—	—	—	—	1.7	18	90351	2.2	25	90354	—	—	—
0.9	9.5	90259	1.2	13	90257	1.4	15	98514	1.7	18	90351	3.1	33	99999 <sup>a</sup>

<sup>a</sup> without link  
<sup>b</sup> can be equipped with heel/kick-out

**For further information, contact your Volvo BM representative.**

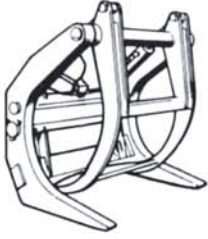
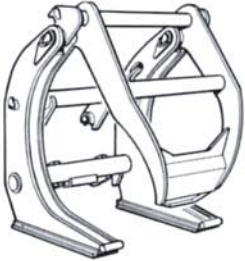
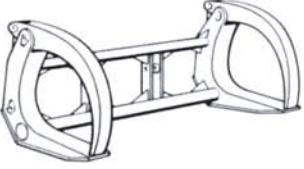
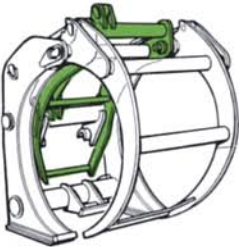
		Timber/ pulpwood length		Mount- ing R* D**	622/642 Area		Order No.	4200 B cassette
		m	ft		m <sup>2</sup>	ft <sup>2</sup>		
	<p><b>SORTING GRAPPLE (pulpwood, narrow)</b></p> <p>Especially suitable for handling in narrow bins. This grapple cannot be equipped with heel/kick-out.</p>	3	10	R	0.9	9.5	98730	—
		4.5	15	R	—	—	—	—
	<p><b>WHOLE-STEM GRAPPLE</b></p> <p>This grapple has a wide grip for greater stability. Specifically designed for handling whole trunks, i.e. a small grip area can be obtained.</p>	—	—	R	0.7	7.5	98883	—
	<p><b>TROPICAL TIMBER GRAPPLE</b></p> <p>For handling large saw-logs. It is extremely wide and has two separate clamps to hold these logs securely.</p>	—	—	D	—	—	—	—
	<p><b>HEEL/KICK-OUT</b></p> <p>Hydraulically operated. Delivered as kit, with assembly not included in price. The attachment requires an extra hydraulic control.</p>							



**HI-LIFT SWIVEL WOOD CLAMP**

The hi-lift SWC handles pulpwood in 2–3 metre lengths. It is designed for unloading vehicles to a stack or feed table. It is also suitable for transporting wood from a stack to a feed table. The SWC is designed for mounting in the attachment bracket. Two extra hydraulic controls are required.



4200 B			4300 B			4400			4500			4600 B		
Area m <sup>2</sup>	ft <sup>2</sup>	Order No.	Area m <sup>2</sup>	ft <sup>2</sup>	Order No.	Area m <sup>2</sup>	ft <sup>2</sup>	Order No.	Area m <sup>2</sup>	ft <sup>2</sup>	Order No.	Area m <sup>2</sup>	ft <sup>2</sup>	Order No.
—	—	—	—	—	—	—	—	—	—	—	—	—	—	—
0.9	9.5	98730	—	—	—	—	—	—	—	—	—	—	—	—
—	—	—	—	—	—	—	—	—	—	—	—	—	—	—
0.7	7.5	98893	0.7	7.5	98893	1.1	12	98878	1.1	12	98878	—	—	—
—	—	—	—	—	—	—	—	—	—	—	—	—	—	—
—	—	—	—	—	—	0.9	9.5	98952	0.9	9.5	98952	1.4	15	99205

For grapple No. 90257

No. 90351  
No. 98514  
No. 90354  
No. 99999  
No. 90259  
No. 99323  
No. 90257  
No. 99745

Use heel/kick-out No. 90258

No. 90352  
No. 99053  
No. 90355  
No. 90001  
No. 90260  
No. 99279  
No. 90258  
No. 90001

Timber/ pulpwood length m	4400		4500			
	Area m <sup>2</sup>	ft <sup>2</sup>	Order No.	Area m <sup>2</sup>	ft <sup>2</sup>	Order No.
2.0—2.5	6.5—	8.2	1.8	19	99534	—
2.5—3.0	8.2—	10.0	1.5	16	99535	1.8
						19
						99534

Frame order No. 99533

## LOG PUSHER

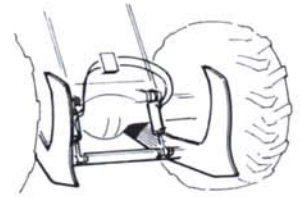

Recommended for all roundwood handling.

This attachment is useful in high stack work and for clearing a path in front of the loader's wheels. The attachment requires an extra hydraulic control.

	Order No.
4300B	98054 <sup>1)</sup>
4400	98931 <sup>1)</sup>
4500	98931 <sup>1)</sup>
4600B	99292 <sup>2)</sup>

<sup>1)</sup> Operated with 4th hydraulic control. If the log grapple has kick-out/heel, a 5th hydraulic control is required (99571).

<sup>2)</sup> Necessary control equipment included.

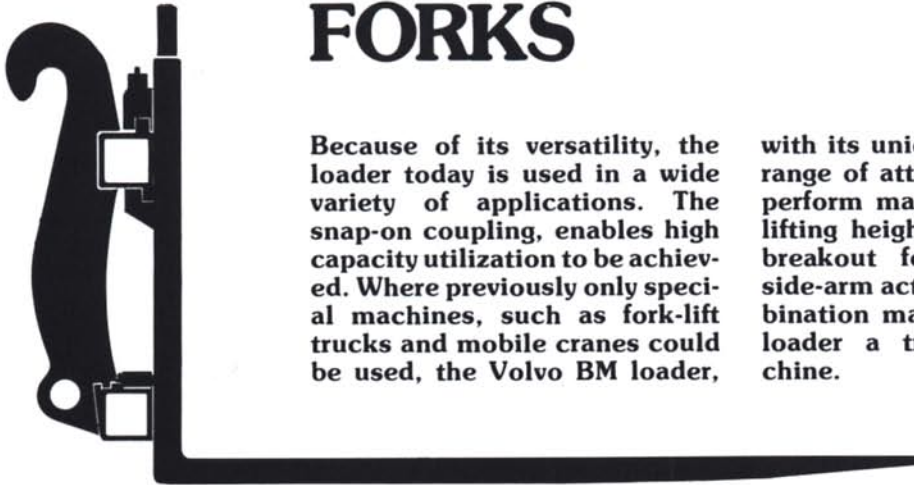

# FORKS

Because of its versatility, the loader today is used in a wide variety of applications. The snap-on coupling, enables high capacity utilization to be achieved. Where previously only special machines, such as fork-lift trucks and mobile cranes could be used, the Volvo BM loader,

with its unique loader unit and range of attachments, can now perform many functions. Good lifting height, long reach, high breakout forces and parallel side-arm action are a great combination making the Volvo BM loader a truly all-round machine.

**622/642**

Order No.

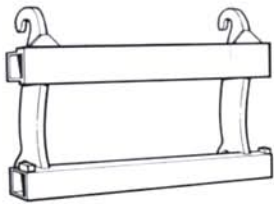

## FORK FRAME

For materials handling. Can be combined with different fork tines. Available in three different widths.

Width	mm 1200	3' 11"	97791
	ft in 1500	4' 11"	97792
	2000	6' 7"	97793
	2260	7' 5"	—

## BREAKOUT FORK FRAME

Extra heavy-duty. Intended for heavy work requiring high-breakout force, e.g. stone extraction.

Width	mm 1200	3' 11"	98385
	ft in 1500	4' 11"	98386
	2000	6' 7"	98387

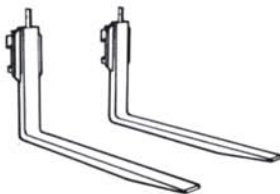

## FORK TINES

Available in three different lengths. To be combined with the above fork frames.

**NOTE! The order No. is for one fork tine only.**

Length	mm 1050	3' 5"	97788
	ft in 1225	4'	97789
	1450	4' 9"	97790
	1500	4' 11"	—

## BREAKOUT FORK TINES

Available in two different lengths. To be combined with the above breakout fork frame.

**NOTE! The order No. is for one fork tine only.**

Length	mm 1050	3' 5"	98389
	ft in 1225	4'	98390
	1450	4' 9"	98391

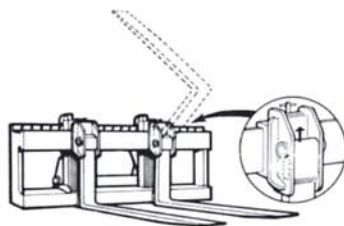

## HINGED FORK TINES

Used where irregularities in the ground make the load difficult to pick up with conventional fork tines. The upward movement of the tines is 75 mm (3 in). They can also be folded back for safety when driving on public roads.

**NOTE! The order No. is for one fork tine only.**

Length	mm 1050	3' 5"	—
	ft in 1225	4'	98098
	1450	4' 9"	—

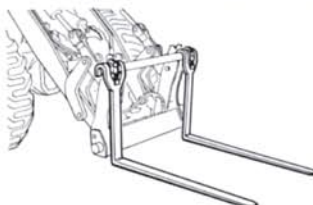

## DIRECT-MOUNTED FORK TINE

Mounted directly on the attachment bracket.

**NOTE! The order No. is for one fork tine only.**

Length	mm 1050	3' 5"	98944
	ft in 1225	4'	98943
	1450	4' 9"	98945





*Volvo BM loaders are stable and have a loader unit that combines long reach with parallel lift-arm action. Therefore they are very well suited for use with fork attachments.*

<b>4200 B cassette Order No.</b>	<b>4200 B Order No.</b>	<b>4300 B Order No.</b>	<b>4400 Order No.</b>	<b>4500 Order No.</b>	<b>4600 B Order No.</b>
97791	97791	97791	98385	98385	—
97792	97792	97792	98386	98386	—
97793	97793	97793	98387	98387	—
—	—	—	—	—	99542
—	98385	98385	—	—	—
—	98386	98386	98890	98890	—
—	98387	98387	—	—	—
97788	97788	97788	98389	98389	—
97789	97789	97789	98390	98390	—
97790	97790	97790	98391	98391	—
—	—	—	—	—	99845
—	98389	98389	97795	97795	—
—	98390	98390	—	—	—
—	98391	98391	97796	97796	—
—	—	—	98103	98103	—
98098	98098	98098	98104	98104	—
—	—	—	98105	98105	—
98944	98944	—	—	—	—
98943	98943	—	—	—	—
98945	98945	—	—	—	—

## **FORK QUALITY**



Volvo BM's fork attachments meet varying needs. From extra-heavy-duty break-out forks, to forks with hydraulic tine positioning, you can choose the best for your particular handling needs. Only high quality material is used in manufacture. Inspection and classification are done to rigorously applied standards.

**For further information, contact your Volvo BM representative.**

# AGILITY



Confined spaces in storage yards, warehouses and on wharfs present no problem to the articulated loader. It offers outstanding manoeuvrability, good visibility and good control over machine and work. The machine has impressive lifting height and reach for work on high stacks. In addition, wide vehicles can be loaded completely from one side, to shorten work cycles.

622/642

Order No.

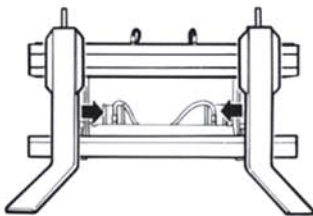

## PALLET FORK WITH FORK POSITIONER

This type of fork frame is ideal for varying load widths. With it the fork tines can be adjusted to suit the width of the load and both tines can be positioned simultaneously. Assembly components included.

**NOTE! Fork tines not included.**

Width mm *ft in* 1500 4' 11"  
Adjustment range:  
300–1350 mm 1' – 4' 5"

99226

Width mm *ft in* 2000 6' 7"  
Adjustment range:  
300–1750 mm 1' – 5' 9"

—

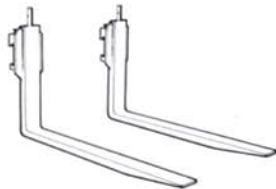

## FORK TINES FOR THE ABOVE

There are three types of tines for use with the above fork frame for handling different materials. Note! Excessively long fork tines can damage materials located behind the load when picking up or setting down.

**NOTE! The order No. is for one fork tine only.**

Length mm 1050 3' 5"  
*ft in* 1225 4'  
1450 4' 9"

99228

99229

99230

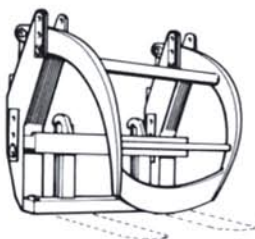

## COMBI-FORK WITH ONE-PIECE CLAMP

A fork which is recommended for handling of palletized goods and roundwood. Max. height of palletized goods 1200 mm (47 in). Hinged fork tines will make handling on uneven surfaces far easier.

**The attachment requires an extra hydraulic control. Fork tines not included.**

Width mm 2000 6' 7"  
*ft in*

97949

Width mm 1750 5' 9"  
*ft in*

—

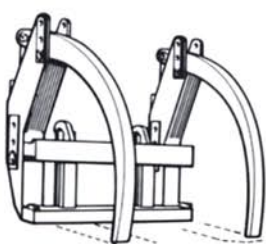

## COMBI-FORK WITH TWIN-ARM CLAMP

This fork is suitable for materials handling at pulp mills, on building sites etc. The clamping arms are automatically adjusted to provide a secure grip.

**The attachment requires an extra hydraulic control. Fork tines not included.**

Width mm 2000 6' 7"  
*ft in*

97950

Width mm 1750 5' 9"  
*ft in*

—



# HIGH ATTACHMENT

High side-arm attachment is very important in such functions as pallet handling. The clearance achieved enables working across wide trucks and railway cars without the side arms fouling the vehicle.



4200 B cassette Order No.	4200 B Order No.	4300 B Order No.	4400 Order No.	4500 Order No.
99226	99226	99226	—	—
—	—	—	99231	99231
99228	99228	99228	99232	99232
99229	99229	99229	99233	99233
99230	99230	99230	99234	99234
97949	97949	97949	—	—
—	—	—	98648	98648
97950	97950	97950	—	—
—	—	—	98647	98647

## FORK TINE EXTENSION

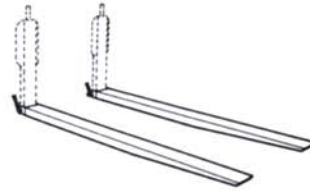

Intended for handling of light materials. When the centre of gravity is 1250 mm (4' 1") from the frame, the maximum load per tine is: for the 4300B 1000 kg (2200 lb)/tine; for the 4400 and 4500, 1750 kg (3850 lb)/tine.

**NOTE! The Order No. is for one fork tine only.**

Fits	Length mm / ft in	Order No. fork tine	mm (in)	
			mm	(in)
622/642	2500/ 8' 2"	99107	125 × 50	(5 × 2)
4200B cassette	2500/8' 2"	99107	125 × 50	(5 × 2)
4200B	2500/8' 2"	99107	125 × 50	(5 × 2)
4300B	2500/8' 2"	99107	125 × 50	(5 × 2)
4400	2500/8' 2"	99444	150 × 60	(6 × 2.4)
4500	2500/8' 2"	99444	150 × 60	(6 × 2.4)

## PROTECTION BARS

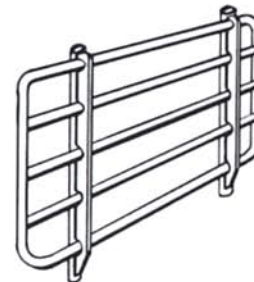

Width 1200 mm (3' 11")  
Height 600 mm (2')

This type of attachment can be mounted on both old and new fork tines. The former type has a tube for mounting while the latter has a pin. The attachment is used for handling materials which need supporting to prevent their falling backwards over the frame.

Order No. 98568 fits all fork attachments through the 4500 model.

# SPECIAL ATTACHMENTS

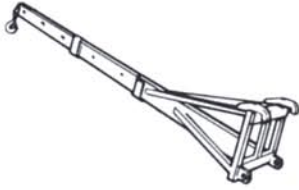

## CRANE JIB

The crane jib is used on construction sites for pipelaying etc. It has two telescopic sections with built-in mechanical stop to prevent over-extension.

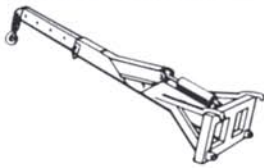

The attachment requires an extra hydraulic function.

## HYDRAULIC ARTICULATED CRANE JIB

This crane jib has a telescopic outer section which can also be cranked hydraulically. It is particularly useful on sites where loads have to be lowered below ground level, or where various obstacles have to be negotiated. The jib has a line rupture valve and the outer section lowers at a restricted rate.

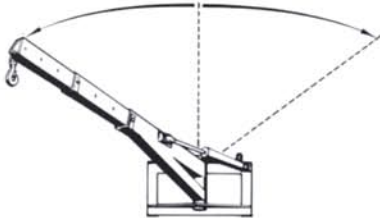

## HYDRAULIC PIVOTED CRANE JIB

The crane jib can be hydraulically slewed 30° in either direction, which makes it particularly suitable for precision work. This jib has two extendable sections.

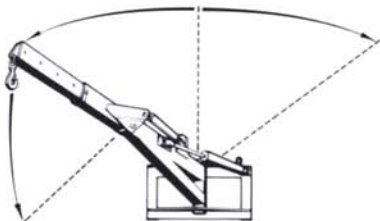

## HYDRAULIC PIVOTED AND ARTICULATED CRANE JIB

This crane jib, with one telescopic section, has two hydraulic cylinders, one for raising/lowering and one for slewing the entire jib 30° in either direction. It is used where loads have to be lifted over obstacles and positioned with precision. The oil flow to the control cylinder is constricted to allow high precision control.

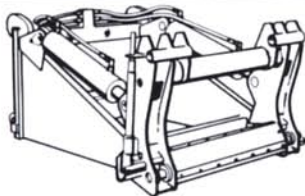

## EXTENSION

The extension is recommended for work with a pallet fork, bucket etc. where lifting height and long reach are required for light loads.

The attachment requires an extra hydraulic control.

*Extension mm ft in 1000 3'3"*

*Extension mm ft in 1500 4'11"*

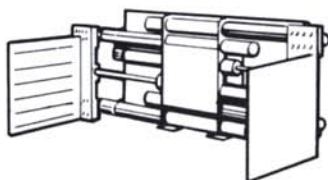

## HYDRAULIC BALE HANDLER

This attachment is intended for handling baled material, e.g. pulp bales, light scrap bundles etc.

The attachment requires an extra hydraulic control.

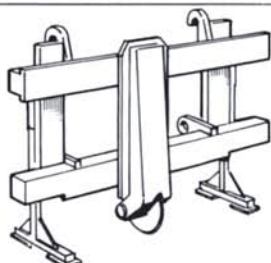

## ASPHALT CUTTER

Facilitates removal of asphalt for repair work on roads, pavements etc. This attachment makes one cut so that the asphalt edge is not damaged during excavation work.

Cutting depth 50—70 mm (2—3 in).

Mounted on fork frame.



<b>622/642</b> Order No.	<b>4200 B</b> cassette Order No.	<b>4200 B</b> Order No.	<b>4300 B</b> Order No.	<b>4400</b> Order No.	<b>4500</b> Order No.
97824	97824	97824	97824	98761	98761
97819	97819	97819	97819	98762	98762
98616	—	—	—	—	—
98617	—	—	—	—	—
98094 —	— —	— —	— —	98646 98713	98646 98713
98067	98067	98067	98067	99166	99166
97815	97815	97815	97815	97815	97815

**For further information, contact your Volvo BM representative.**



**622/642**

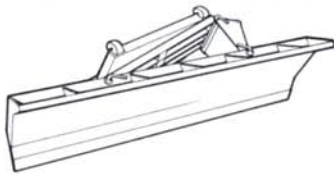

**DOZER BLADE**

The dozer attachment, intended for dozing and leveling work, has a blade that can be angled 20° to the left or right. The wear plates can be reversed.

Holms OrderNo. F32550

Working width mm ft in 2500 8'2"

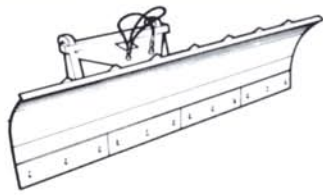

**SNOW BLADE Type KH (municipal blade)**

Recommended for snow clearance of roads etc. The blade has a reversible cutting edge divided into sections which fold back when they run into low obstructions such as manhole covers. The blade can be angled hydraulically 30° and is mounted with spring suspension, permitting variable ground pressure and full conformance to the road surface.

Holms OrderNo. F31975

Working width mm ft in 3200 10'6"

The attachment requires an extra hydraulic control.

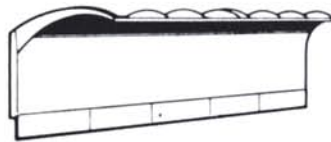

**SNOW BLADE Type TKH-100 (municipal blade)**

Recommended for snow clearance of roads etc. The blade has a reversible cutting edge divided into sections which fold back when they run into low obstructions such as manhole covers. It is hydraulically adjustable 35° and is mounted with spring suspension.

Holms OrderNo. F32125

Working width mm ft in 3200 10'6"

The attachment requires an extra hydraulic control!

Holms OrderNo. F32225

Working width mm ft in 4000 13'2"

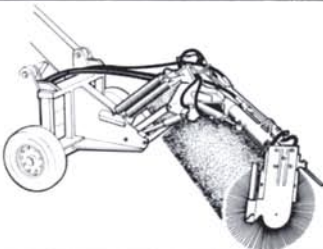

**SWEEPER (without collection)**

Designed for use where the sweepings do not have to be collected. Can be equipped with water tank and spray nozzle for dust laying. For continuous service, a hydraulic oil cooler may be required.

Holms OrderNo. F22200

Working width mm ft in 2200 7'3"

Single-acting lift function required. Revolution counter recommended.

Holms OrderNo. F22300

Working width mm ft in 2500 8'2"

The attachment requires an extra hydraulic control!

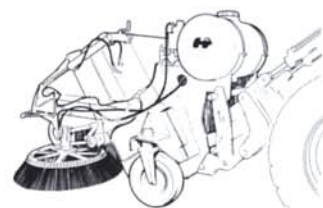

**SWEEPER Holms 601**

A fully hydraulic, collecting sweeper with high-pressure watering. It has a high rotation speed and efficient collection.

Holms OrderNo. F20001

Working width mm ft in 2500 8'2"

The Holms 601 is connected directly to the loader's attachment bracket. The sweeper is compatible with the hydraulic flow of the loader. For continuous service particularly in hot weather, a hydraulic oil cooler may be required. Single-acting lift function required, revolution counter recommended.

The attachment requires an extra hydraulic control.

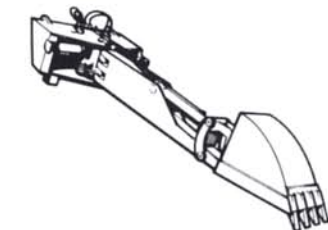

**POSTHOLE DIGGER**

An excavator for small-scale excavation work such as service excavation, digging of cable trenches, post-holes etc.

Digging depth 3500 mm (11'6")

Swing angle 170°

Dumping height 3100 mm (10'2")

OrderNo. 97977

Lever set No. 98752 required, together with 3rd and 4th hydraulic controls.



**EXCAVATION BUCKET**

Three different buckets are available for the posthole digger. They can easily be mounted and dismounted.

Posthole bucket 50 litres (1.9 ft<sup>3</sup>) 4 teeth

Cable bucket 96 litres (3.4 ft<sup>3</sup>) 3 teeth

Excavator bucket 167 litres (5.9 ft<sup>3</sup>) 4 teeth

Order No. 97822

" 97823

" 97821



4200 B cassette	4200 B	4300 B	4400	4500
F32550 2500 8'2"	F32550 2500 8'2"	F32550 2500 8'2"	— —	— —
F31975 3200 10'6"	F31975 3200 10'6"	F31975 3200 10'6"	— —	— —
— —	F32125 3200 10'6"	F32125 3200 10'6"	F32125 3200 10'6"	— —
— —	— —	F32225 4000 13'2"	F32225 4000 13'2"	F32225 4000 13'2"
F22200 2200 7'3"	— —	— —	— —	— —
F22300 2500 8'2"	F22300 2500 8'2"	F22375 2500 8'2"	F22350 2500 8'2"	— —
— —	F20001 2500 8'2"	F20002 2500 8'2"	F20003 2500 8'2"	— —
—	—	—	—	—
— — —	— — —	— — —	— — —	— — —

**For further information, contact your Volvo BM representative.**



*Volvo BM loaders have a modern, functional range of attachments. You can always find one for your particular needs.*

---

# **VOLVO BM**

**VOLVO BM AB ESKILSTUNA SWEDEN**

**Ref.No. 21 2 669 1708**  
**ENGELSKA**

Production group for basic printed matter Volvo BM  
Foto: Foto Consult, Studio Roland, Rolf Lembrus