

# D10T

## Track-Type Tractor



### Engine

|                |                |        |
|----------------|----------------|--------|
| Engine Model   | Cat® C27 ACERT |        |
| Gross Power    | 482 kW         | 646 hp |
| Flywheel Power | 433 kW         | 580 hp |

### Weights

|                  |           |            |
|------------------|-----------|------------|
| Operating Weight | 66 451 kg | 146,500 lb |
| Shipping Weight  | 48 263 kg | 106,400 lb |

- **Operating Weight:** Includes hydraulic controls, blade tilt cylinder, coolant, lubricants, 100% fuel, ROPS, FOPS cab, SU-Blade, Single-Shank Ripper, 610 mm (24 in) ES shoes, and operator.
- **Shipping Weight:** Includes coolant, lubricants, 20% fuel, ROPS, FOPS cab, and 610 mm (24 in) ES shoes.

# D10T Track-Type Tractor

*Strength from the past. Power for the future.™ The D10T combines power and efficiency with advanced technology for outstanding production at a lower cost-per-yard.*

---

## C27 Engine with ACERT® Technology

- ✓ ACERT Technology works at the point of combustion to optimize engine performance and to provide low exhaust emissions. Matched with the torque divider and power shift transmission, it provides years of dependable and efficient service. **pg. 4**

---

## Operator Station

- ✓ Designed for operator comfort, convenience, and productivity. Machine control and vital information is provided at the operator's fingertips. A full day of work is no problem in this efficient work place. **pg. 6**

---

## Implement and Steering Controls

- ✓ Electro-hydraulic implement controls allow low operator effort for dozing and ripping. Steering and gear selection in a one-hand control system enhances operator comfort. **pg. 8**

---

## Work Tools

Various bulldozer blades, rippers, winches, and other options allow you to adapt the D10T to match your specific application, making you more productive. **pg. 12**

---

## Serviceability and Customer Support

- ✓ Combining easy to access, modular components with your Caterpillar® Dealer's advanced rebuild and repair capabilities ensure rapid component replacement and minimum downtime. **pg. 13**

*Engineered for demanding work.*

*The durable construction of the D10T is well suited for tough working conditions. Combined with the C27 engine for superior performance, fuel economy and meeting emission targets with the help of ACERT Technology, it keeps material moving with the reliability and low operating costs you expect from Cat tractors.*





---

### Drive Train

The electronically controlled power shift transmission, efficient clutch/brake steering and durable planetary final drives deliver outstanding power transfer and long life to ensure maximum productivity. **pg. 9**

---

### Undercarriage

The proven elevated sprocket undercarriage isolates the drive train components from ground-induced impacts. The suspended undercarriage puts more track on the ground for higher traction and less track slip. It absorbs shocks for a smoother ride and longer machine life. **pg. 10**

---

### Structure

- ✓ Mainframe is heavy, strong and durable. Full box sections, steel castings and continuous rolled rails provide durable support to the suspended undercarriage, elevated final drives and other integral frame components. **pg. 11**



✓ *New Feature*

## C27 Engine with ACERT® Technology

*A combination of innovations working at the point of combustion, ACERT Technology optimizes engine performance while meeting EPA Tier 3 and EU Stage IIIa engine exhaust emission regulations for off-road applications.*



**C27 Engine.** Performing at full-rated net power of 433 kW (580 hp) at 1800 rpm with a high torque rise of 21 percent, the large displacement and high torque rise allow the D10T to doze through tough material. Matched to the high efficiency torque divider and electronically controlled power shift transmission, it will provide years of dependable service.

**C27 Block.** The C27 eliminates internal bends and turns within the engine resulting in improved airflow. The block features a design that adds structural strength through compaction and thicker walls. This design supports the engine's higher compression ratios.

**Overhead Cams.** Two, single (one per head) overhead cams are driven by gears on the flywheel end of the engine. Placing the cam gears at the flywheel end significantly reduces noise and vibration. To reduce wear, two pendulum absorbers are mounted at the front of the camshafts. Together, these two features contribute to the long-life and durability of this engine.



### **ADEM™ A4 Engine Controller.**

The ADEM A4 electronic control module manages fuel delivery and airflow to get the best performance per gallon (liter) of fuel used. It provides flexible fuel mapping, allowing the engine to respond quickly to varying application needs. It keeps track of engine and machine conditions while keeping the engine operating at peak efficiency.



**Fuel Delivery.** Multiple injection fuel delivery involves a high degree of precision. Precisely shaping the combustion cycle lowers combustion chamber temperatures, generating fewer emissions and optimizing fuel combustion; translating into more work output for your fuel used.

**MEUI Fuel System.** A highly evolved fuel system with a proven record of reliability in the field. MEUI combines the technical advancement of an electronic control system with the simplicity of direct mechanically controlled unit fuel injection. The MEUI system excels in its ability to control injection pressure over the entire engine operating speed range. These features allow the C27 to have complete control over injection timing, duration, and pressure.

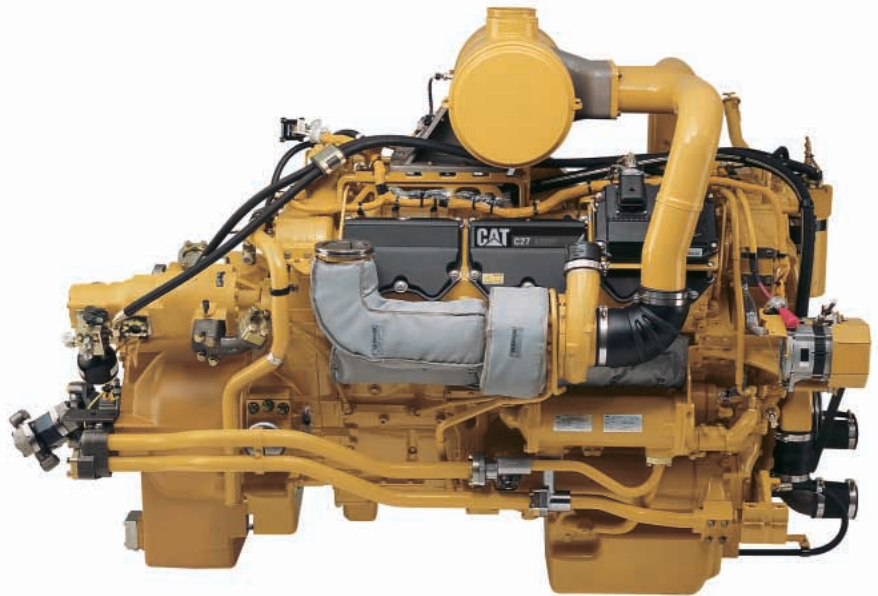
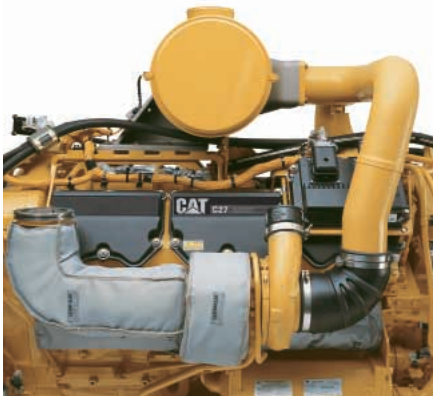

**ATAAC and Airflow.** Air-to-air aftercooling keeps air intake temperatures down and, in concert with the tight tolerance combustion chamber components, maximizes fuel efficiency and minimizes emissions. Significant improvements in air flow are generated by water-cooled turbochargers, unique cross-flow head, single rear-driven overhead cams, and a more efficient intake manifold.

**Service.** Easier maintenance and repair through monitoring key functions and logging critical indicators. Electronic diagnostic access is possible with a single tool, the Caterpillar Electronic Technician.

## Operator Station

*Designed for operator comfort, convenience, and productivity, the state-of-the-art cab sets a new standard.*





**1) Steering Control.** Finger Tip Control (FTC) combines steering, machine direction and gear selection into a single control system, which can be operated with one hand for enhanced operator comfort.

**2) Cat Comfort Series Seat.**

Fully adjustable and designed for comfort and support. Thick seat and back cushions provides support for the lower back and thighs, while allowing unrestricted arm and leg movement. Wide retractable seat belt provides positive, comfortable restraints.

**3) Adjustable Armrests.** Standard adjustable armrests provide additional comfort for the operator.



**4) Electronic Ripper Control.** A rigidly mounted handgrip, with low effort thumb and finger controls, provides firm support and positive control of the ripper when operating in tough conditions. Programmable features, such as Auto Lift, Shank-Out and Auto Stow, increase efficiency for the operator.

**5) Electronic, Programmable Dozer Control.** Features such as blade response, blade float, auto blade pitch, and spread rate can be set and adjusted using the Advisor panel. Auto Blade Assist (standard) and AutoCarry (optional) make the tractor even more efficient in specific applications.

**6) Cat Monitoring Display System.**

The combination dash mounted instrument cluster and the Advisor Monitoring System provide key machine operating information and give the operator and service technician insight into the machine's operation and maintenance needs.

**In-Dash Instrument Cluster.**

The instrument panel, with easy-to-read gauges and warning lamps, keeps the operator aware of any potential problems. All gauges and readouts are easily visible in direct sunlight.

**Advisor Monitoring System (AMS).**

On-board diagnostic abilities minimize downtime and maximize machine performance.

**7) Wide Panoramic View.** The operator station offers an exceptional viewing area. A large view hole in the single-shank ripper frame provides a view of the ripper tip. The tapered hood, notched fuel tank, and narrow single-shank ripper carriage gives the operator a clear line of sight to the front and rear work areas. The large single-pane door windows provide an excellent view to the sides and blade.

**8) Heating and Air Conditioning.**

Conveniently located air circulation vents evenly distribute airflow within the cab. Controls are easily accessible from the operator seat.



**Fuse Panel and Diagnostic Access.**

The new compartment features a single location fuse panel that includes a diagnostic port for the Cat ET to connect for rapid machine diagnostics.

**Comfortable Operation.** Standard isolation-mounted cab reduces noise and vibration. The cab is pre-wired for a 12-volt or 24-volt radio, equipped with two speakers, an antenna and a radio mount recessed in the headliner.

## Implement and Steering Controls

*Low effort control functions significantly reduce operator fatigue for increased performance.*



**Dozer Control Lever.** A low-effort electronic dozer control handle gives the operator control of all dozer functions with one hand. Fore/aft movement of the lever lowers and raises the blade. Left/right movement directionally tilts the blade.

When equipped with the optional Dual Tilt feature, the thumb lever at the top of the handle controls blade pitch fore and aft. The trigger switch toggles between single and dual tilt.

The left and right side thumb buttons provide control over the semi-automated blade pitch functions that the Dual Tilt attachment provides. Blade pitch for load, carry and spread segments can be preset on Advisor and controlled by the buttons. The left side button cycles between the pitch settings for each segment of the push cycle. The right side button cancels out of the pitch functions without losing the preset pitch angles. This Auto Blade Assist (ABA) feature is turned on and off using a switch on the right side console.

The two buttons also provide control over the AccuGrade™ blade control attachment when the machine is so equipped. The buttons turn on AccuGrade, provide manual increment and decrement control, and turn off AccuGrade.

**Computer Aided Earthmoving System (CAES) (optional).** This on-board electronic site plan directs machine operators, in real-time, where to cut and fill. A graphical map of the design plan and a view of the machine's horizontal and vertical position simplify operation and enhance production.

This advanced information tool combines GPS technology (centimeter-level) and in-cab computing capabilities for precise grade and slope control. It has proven to provide measurable impact on work quality and overall productivity. Ideal applications include benches, roads, leach pads, dump areas, and reclamation sites.

The faster, more precise grade guidance delivered by this system helps operators do their jobs to specification the first time, eliminating costly re-work. It also allows work to proceed in poor visibility conditions and without surveying delays, so equipment is better utilized. And because operators get constant, accurate feedback without looking for survey stakes or paper maps, they work more confidently and efficiently.



**Ripper Control Lever.** A rigidly mounted handgrip provides firm support for the operator even when ripping in the roughest terrain. The low effort thumb lever controls raising and lowering. The finger lever controls shank-in and shank-out positioning. The thumb button automatically raises the ripper.



**Finger Tip Controls (FTC).** Clustered for easy, one-hand operation to the operator's left. They control steering, machine direction and gear selection.



## Drive Train

The drive train provides maximum efficiency in combination with the C27 engine with ACERT Technology.



**Torque Divider.** A single-stage torque converter with output torque divider sends 75 percent of engine torque through the converter and 25 percent through a direct drive shaft for greater driveline efficiency and higher torque multiplication. The torque converter shields the driveline from sudden torque shocks and vibration.

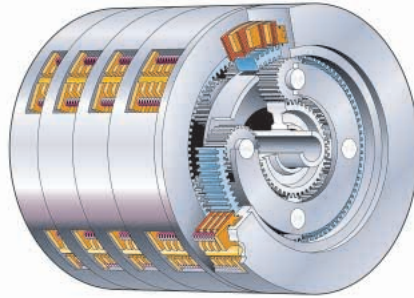

### Planetary Power Shift Transmission.

Three speeds forward and three speeds reverse, utilizing large diameter, high-capacity, oil-cooled clutches.

- Modulation system permits fast speed and direction changes.
- Modular transmission and bevel gear slide into rear case for servicing ease, even with ripper installed.
- Oil-to-water cooler for maximum cooling capacity.
- Forced oil flow lubricates and cools clutch packs to provide maximum clutch life.

### Electronic Clutch Pressure Control.

The Finger Tip Control (FTC) system has an additional drive train feature for added performance, Electronic Clutch Pressure Control (ECPC). This feature provides smoother shifting by modulating individual clutches. ECPC also provides the auto-shift and auto-kickdown feature.

**Steering Clutch and Brake.** Fade resistant and adjustment free. The multi-disc, oil-cooled steering clutches are hydraulically applied and electronically controlled. The brakes are applied by springs and hydraulically released for safe and reliable braking performance.

Power Shift with Steering Clutch and Brake

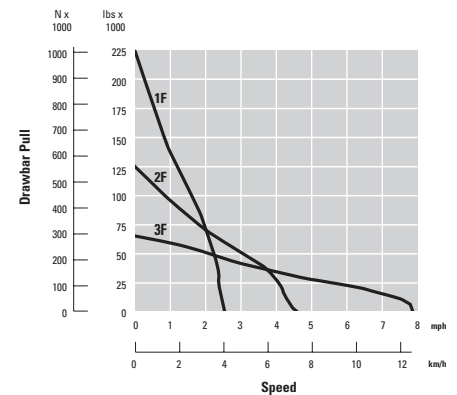

### Drawbar Pull vs Ground Speed.

As loads on the tractor increase, the D10T offers unmatched lugging capability and smooth shifting as the need occurs to change gears under varying loads. The 3-speed forward, 3-speed reverse transmission offers excellent runout speeds.

**Elevated Final Drives.** Isolated from ground and equipment induced impact loads for extended power train life.

- Crown-shaved drive gears provide smooth, quiet, low maintenance operation.
- Splash lubrication and Duo-Cone® Seals extend service life.

**Modular Power Train.** The modular power train design permits quick removal and installation of major components such as the engine, transmission and final drives.

## Undercarriage

*The Caterpillar elevated sprocket undercarriage is designed for optimized machine balance and best possible performance and component life.*



### **Suspended Undercarriage Design.**

Suspended undercarriage design absorbs impact loads, to reduce the shock loads transferred to the undercarriage, by up to 50 percent in uneven terrain.

**Bogie Suspension.** Bogie suspension conforms closely to the ground providing up to 15 percent more ground contact, especially in hard, uneven terrain. Higher traction means less slippage, better balance, and a smoother ride.



### **Integrated Carrier Roller Mount.**

The carrier roller mount is cast into the track roller frame making it easier to add the optional carrier roller in the field, if conditions require it.

**Rollers and Idlers.** Feature symmetric Duo-Cone seals for long sealing life to prevent oil loss and dirt entry. Toric rings maintain performance over a wide range of temperatures. Rollers and idlers are serviceable and rebuildable to provide value. Abutment-style caps securely attach rollers and idlers to the bogies.

**Roller Frames.** Roller frames are tubular to resist bending and twisting, with added reinforcement where operating loads are highest.

- Roller frames attach to tractor by a pivot shaft and pinned equalizer bar.
- Large pivot shaft bushings operate in an oil reservoir.

- A low friction, no maintenance bushing is used in the saddle connection.
- Aligned to use more of the available wear material, running the track to the outside of the rollers in forward and to the inside in reverse.

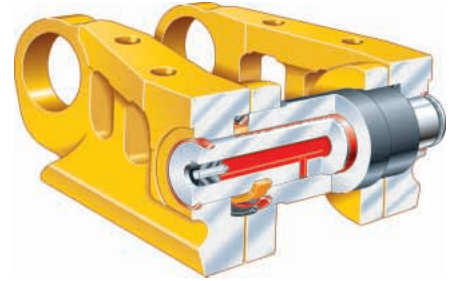

**Positive Pin Retention (PPR) Sealed and Lubricated Track.** Designed for high-impact and high load applications. The PPR exclusive Caterpillar design locks the link to the pin.

**Sprocket Segments.** Made exclusively of Caterpillar Tough Steel™ for longer wear life and precision machined after heat treat for proper fit. Segments can be removed or replaced without breaking the track.

**Track Shoes.** Track shoes are available in a variety of sizes and styles to match the working conditions.



## Structure

*Engineered to provide durability and the solid support necessary for maximum production and service life in the most demanding work.*



**Mainframe Strength.** The D10T mainframe is built to absorb high impact shock loads and twisting forces.

**Frame Rails.** Full box section, designed to keep components rigidly aligned.

**Heavy Steel Castings.** Add strength to the main case, equalizer bar saddle, front cross member and tag-link trunnion.

**Top and Bottom Rails.** Continuous rolled sections, with no machining or welding, to provide superior mainframe durability.

**Main Case.** Elevates the final drives well above the ground level work area to protect them from impact loads, abrasion and contaminants.

**Pivot Shaft.** The D10T pivot shaft runs through the mainframe and connects to the roller frames, allowing independent oscillation. The full-length pivot shaft distributes impact loads throughout the case, reducing the bending stress on the case.

**Equalizer Bar.** The equalizer bar features limited slip seals and an oil-lubricated joint for better oil flow. Remote lube passages simplify maintenance. Large forged pads reduce wear on the mainframe and extend sealed joint life.



### Engine and Radiator Guard Mount.

The new fabricated common front engine and rear radiator mount feature heavy castings.



**Tag-Link.** The Tag-Link brings the blade closer to the machine for more precise dozing and load control.

The Tag-Link design provides solid lateral stability and better cylinder positions for constant break out force, independent of blade height.

## Work Tools

*Work Tools and Ground Engaging Tools (G.E.T.) provide the flexibility to match the machine to the job, maximizing performance.*



**Bulldozers.** All blades feature a strong box-section design that resists twisting and cracking. Blades are made of Cat DH-2™ steel that has high tensile strength and stands up to the most severe applications. Heavy moldboard construction and hardened bolt-on cutting edges and end bits add strength and durability.

• **Semi-Universal Blade.** The Semi-Universal blade is built for tough applications where penetration is more important than capacity. The “SU” blade is more aggressive in penetrating and loading material than the “U” blade. The blade wings are designed for superior load retention and penetration in tightly packed materials and for finishing applications. Can also be configured with a push plate for push loading scrapers.

• **High-Capacity Universal Blade.**

The high-capacity Universal blade offers maximum capacity and is perfect for moving big loads over long distances. The “U” blade has large blade wings and is ideal for stockpile work, reclamation, charging hoppers or trapping for loaders.

**Optional Dual Tilt.** Improves load control and allows the operator to optimize the blade pitch angle for each portion of the dozing cycle.

**Single Lever.** Controls all blade movements, including the optional dual tilt.

**Cutting Edges and End Bits.** Cutting edges are made of DH-2 steel. End bits are made of DH-3™ steel to provide maximum service life in tough materials.

**Rippers.** Single and multi-shank rippers are made to penetrate tough material fast and rip thoroughly for use in a variety of materials.



**Single-Shank Ripper.** Operator can adjust the shank depth from the seat using an optional single-shank pin puller. Large upper frame view hole improves ripper tip visibility. Heat treated spacer bars in ripper carriage extend pocket life and reduce shank notching. Large one-piece shank is available in deep ripping configuration.

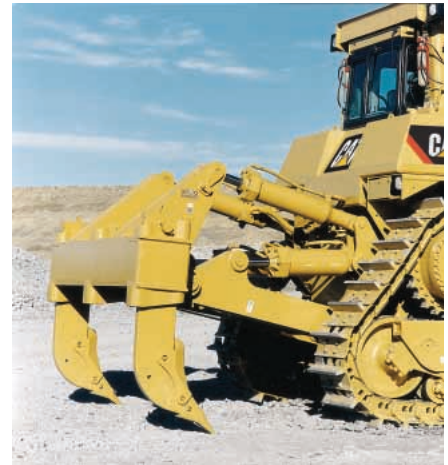

**Multi-Shank Ripper.** Tailors the tractor to the material by using one, two or three shanks.

**Hydraulic Pitch Adjustment Cylinders.** Hydraulic pitch adjustment cylinders vary the shank angle to get the best penetration so the material is lifted and shattered.

**Rear Counterweights.** Provide proper tractor balance to maximize dozing production. Recommended if not equipped with any other rear attachment.

**Winches.** Several options are available. Contact your Caterpillar Dealer.



## Serviceability and Customer Support

*The most serviceable machines from the most committed dealers. World-class product support. The Cat Dealer network trained experts keep your fleet up and running, maximizing your equipment investments. Caterpillar. The difference counts.™*

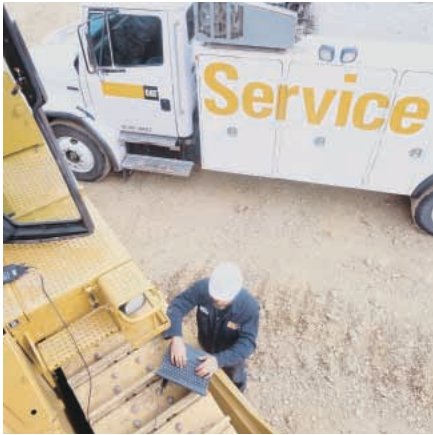

**Serviceability.** Minimizes maintenance and repair downtime. New sight gauges, filter locations, improved access to oil and coolant sampling ports, and an engine compartment mounted work lamp, make daily and periodic service faster and easier. Equipped with a dozer and ripper, there are only 18 lube points.

**Engine Oil Filters.** Engine oil filters are located on the engine for easy servicing access and minimal downtime. Further time is saved with fast fuel and quick oil change attachments.

**Quick Disconnect Fittings.** Allow for fast diagnosis of the power train, hydraulics and attachment oil systems.

**S•O•S<sup>SM</sup> Analysis.** Scheduled Oil Sampling made easier through live sampling ports for the engine oil, hydraulics and coolant.



### **Caterpillar Product Link PL300.**

This option allows the customer or dealer to obtain machine diagnostics and location information from their offices. Product Link PL300 provides updates on service meter hours, machine condition and machine location, as well as integrated mapping/route planning. Built-in flexibility allows for future technology development.

**Machine Selection.** Make detailed comparisons of the machines you are considering before you buy. How long do components last? What is the cost of preventive maintenance? What is the true cost of lost production? Your Cat Dealer can give you answers to these very important questions.

**Purchase.** Consider the financing options available as well as day-to-day operating costs. This is also the time to look at dealer services that can be included in the cost of the machine to yield lower equipment owning and operating costs over the long run.

**Product Support.** Plan for effective maintenance before buying equipment. Choose from your dealer's wide range of maintenance services at the time you purchase your machine. Programs such as Custom Track Service (CTS), S•O•S analysis, Technical Analysis and guaranteed maintenance contracts give peak life and performance to your machine.



**Parts Program.** You will find nearly all parts at your dealer parts counter. Cat Dealers use a world-wide computer network to find in-stock parts to minimize machine downtime.

Ask about your Cat Dealer's exchange program for major components. This can shorten repair time and lower costs.

### **Remanufactured Components.**

Genuine Cat Remanufactured parts save you money. You receive the same warranty and reliability as new products at cost savings of 40 to 70 percent. Components are available for the drive train, engine, and hydraulics.

**Operation.** Improving operating techniques can boost your profits. Your Cat Dealer has training videotapes, literature, and other ideas to help you increase productivity.

## Engine

|                         |               |                         |
|-------------------------|---------------|-------------------------|
| Engine Model            | Cat C27 ACERT |                         |
| Gross Power             | 482 kW        | 646 hp                  |
| Flywheel Power          | 433 kW        | 580 hp                  |
| Net Power – Caterpillar | 433 kW        | 580 hp                  |
| Net Power – SAE J1349   | 428 kW        | 574 hp                  |
| Net Power – EU 80/1269  | 433 kW        | 580 hp                  |
| Net Power – DIN 70020   | 601 PS        |                         |
| Net Power – ISO 1585    | 433 kW        | 580 hp                  |
| Bore                    | 137.2 mm      | 5.4 in                  |
| Stroke                  | 152.4 mm      | 6 in                    |
| Displacement            | 27 L          | 1,647.5 in <sup>3</sup> |

- Engine ratings apply at 1800 rpm.
- Net power advertised is the power available at the flywheel when the engine is equipped with fan at max speed, air cleaner, muffler, and alternator.
- No derating required up to 3658 m (12,000 ft) altitude, beyond 3658 m (12,000 ft) auto derating occurs at 3% per 1000 ft.

## Service Refill Capacities

|                         |        |          |
|-------------------------|--------|----------|
| Fuel Tank               | 1204 L | 318 gal  |
| Cooling System          | 132 L  | 34.9 gal |
| Engine Crankcase*       | 68 L   | 18 gal   |
| Power Train             | 193 L  | 51 gal   |
| Final Drives (each)     | 23 L   | 6 gal    |
| Roller Frames (each)    | 90 L   | 23.8 gal |
| Pivot Shaft Compartment | 30.3 L | 8 gal    |
| Hydraulic Tank          | 144 L  | 38 gal   |

\* With oil filters.

## Weights

|                  |           |            |
|------------------|-----------|------------|
| Operating Weight | 66 451 kg | 146,500 lb |
| Shipping Weight  | 48 263 kg | 106,400 lb |

- Operating Weight: Includes hydraulic controls, blade tilt cylinder, coolant, lubricants, 100% fuel, ROPS, FOPS cab, SU-Blade, Single-Shank Ripper, 610 mm (24 in) ES shoes, and operator.
- Shipping Weight: Includes coolant, lubricants, 20% fuel, ROPS, FOPS cab, and 610 mm (24 in) ES shoes.

## Undercarriage

|                           |                       |                       |
|---------------------------|-----------------------|-----------------------|
| Shoe Type                 | Extreme Service       |                       |
| Width of Shoe             | 610 mm                | 24 in                 |
| Shoes/Side                | 44                    |                       |
| Grouser Height            | 93 mm                 | 3.7 in                |
| Pitch                     | 260 mm                | 10.2 in               |
| Ground Clearance          | 615 mm                | 24 in                 |
| Track Gauge               | 2550 mm               | 100 in                |
| Length of Track on Ground | 3885 mm               | 12.75 ft              |
| Ground Contact Area       | 4.7 m <sup>2</sup>    | 7,326 in <sup>2</sup> |
| Track Rollers/Side        | 8                     |                       |
| Number of Carrier Rollers | 1 per side (optional) |                       |

- Positive Pin Retention Track.

## Track Roller Frame

|             |        |         |
|-------------|--------|---------|
| Oscillation | 351 mm | 13.8 in |
|-------------|--------|---------|

## Hydraulic Controls

|                                     |             |             |
|-------------------------------------|-------------|-------------|
| Pump Type                           | Gear Driven |             |
| Lift Cylinder Flow                  | 404 L/min   | 107 gal/min |
| Tilt Cylinder Flow                  | 112 L/min   | 30 gal/min  |
| Bulldozer Relief Valve Setting      | 18 790 kPa  | 2,725 psi   |
| Tilt Cylinder Relief Valve Setting  | 20 340 kPa  | 2,950 psi   |
| Ripper (Lift) Relief Valve Setting  | 18 790 kPa  | 2,725 psi   |
| Ripper (Pitch) Relief Valve Setting | 18 790 kPa  | 2,725 psi   |
| Tank Capacity                       | 144 L       | 38 gal      |

- Pump output measured at 1800 rpm and 6895 kPa (1000 psi).
- Electro-hydraulic pilot valve assists operations of ripper and dozer controls. Hydraulic system includes four valves for use with blade and ripper.
- Complete system consists of pump, tank with filter, oil cooler, valves, lines, linkage and control levers.

## Steering and Brakes

|   |        |         |
|---|--------|---------|
| Hydraulically applied multiple-disk clutches diameter | 392 mm | 15.4 in |
|---|--------|---------|



## Transmission

|                                 |          |         |
|---------------------------------|----------|---------|
| 1 Forward                       | 4 kph    | 2.5 mph |
| 2 Forward                       | 7.2 kph  | 4.5 mph |
| 3 Forward                       | 12.7 kph | 7.9 mph |
| 1 Reverse                       | 5.2 kph  | 3.2 mph |
| 2 Reverse                       | 9 kph    | 5.6 mph |
| 3 Reverse                       | 15.8 kph | 9.8 mph |
| 1 Forward – Drawbar Pull (1000) | 1000.9 N | 225 lbf |
| 2 Forward – Drawbar Pull (1000) | 556 N    | 125 lbf |
| 3 Forward – Drawbar Pull (1000) | 306.9 N  | 69 lbf  |

## Blades

|   |                     |                      |
|---|---------------------|----------------------|
| Type  | 10SU                |                      |
| Capacity (SAE J1265)  | 18.5 m <sup>3</sup> | 24.2 yd <sup>3</sup> |
| Width (over end bits)   | 4860 mm             | 15.9 ft              |
| Height  | 2120 mm             | 6.9 ft               |
| Digging Depth   | 674 mm              | 26.5 in              |
| Ground Clearance  | 1497 mm             | 58.9 in              |
| Maximum Tilt  | 993 mm              | 39.1 in              |
| Weight*<br>(without hydraulic controls)                             | 10 229 kg           | 22,550 lb            |
| Total Operating Weight**<br>(with Blade and<br>Single-Shank Ripper) | 66 407 kg           | 146,400 lb           |
| Type  | 10U                 |                      |
| Capacity (SAE J1265)  | 22 m <sup>3</sup>   | 28.7 yd <sup>3</sup> |
| Width (over end bits)   | 5260 mm             | 17.25 ft             |
| Height  | 2120 mm             | 6.9 ft               |
| Digging Depth   | 674 mm              | 26.5 in              |
| Ground Clearance  | 1497 mm             | 58.9 in              |
| Maximum Tilt  | 1074 mm             | 42.3 in              |
| Weight*<br>(without hydraulic controls)                             | 10 784 kg           | 23,775 lb            |
| Total Operating Weight**<br>(with Blade and<br>Single-Shank Ripper) | 66 962 kg           | 147,625 lb           |

\* Includes blade tilt cylinder.

\* Add 840 kg (1853 lb) for 10SU ABR blade.

\* Add 1629 kg (3591 lb) for 10U ABR blade.

\*\*Total Operating Weight: Includes hydraulic controls, blade tilt cylinder, coolant, lubricants, 100% fuel, ROPS, FOPS cab, Blade, Single-Shank Ripper, 610 mm (24 in) ES shoes, and operator.

## Rippers

|  |  |            |
|--|--|------------|
| Type   | Single-Shank, Adjustable Parallelogram |            |
| Number of Pockets  | 1                                      |            |
| Maximum Clearance Raised<br>(under tip, pinned in bottom hole) | 1058 mm                                | 41.7 in    |
| Maximum Penetration<br>(standard tip)                          | 1494 mm                                | 58.8 in    |
| Maximum Penetration Force<br>(shank vertical)                  | 205 kN                                 | 45,980 lb  |
| Pry out Force  | 415.3 kN                               | 93,360 lb  |
| Weight<br>(without hydraulic controls)                         | 7117 kg                                | 15,690 lb  |
| Total Operating Weight*<br>(with SU-Blade and Ripper)          | 66 407 kg                              | 146,400 lb |
| Type   | Multi-Shank, Adjustable Parallelogram  |            |
| Number of Pockets  | 3                                      |            |
| Overall Beam Width   | 2920 mm                                | 115 in     |
| Maximum Clearance Raised<br>(under tip, pinned in bottom hole) | 1045 mm                                | 41.1 in    |
| Maximum Penetration<br>(standard tip)                          | 876 mm                                 | 34.5 in    |
| Maximum Penetration Force<br>(shank vertical)                  | 205 kN                                 | 45,980 lb  |
| Pry out Force<br>(Multi-Shank Ripper with one tooth)           | 415.3 kN                               | 93,360 lb  |
| Weight (one shank, without<br>hydraulic controls)              | 7968 kg                                | 17,567 lb  |
| Additional Shank   | 526.2 kg                               | 1,160 lb   |
| Total Operating Weight*<br>(with SU-Blade and Ripper)          | 67 257 kg                              | 148,277 lb |

\* Total Operating Weight: Includes hydraulic controls, blade tilt cylinder, coolant, lubricants, 100% fuel, ROPS, FOPS cab, SU-Blade, Ripper, 610 mm (24 in) ES shoes, and operator.

---

## Winches

---

|             |  |
|-------------|--|
| Winch Model | Consult your Caterpillar Dealer for installation arrangements. |
|-------------|--|

---

## Standards

- ROPS (Rollover Protective Structure) offered by Caterpillar for the machine meets ROPS criteria SAE J1040 MAY94, ISO 3471:1994.
- FOPS (Falling Object Protective Structure) meets SAE J/ISO 3449 APR98 Level II, and ISO 3449:1992 Level II.

## Dimensions

All dimensions are approximate.

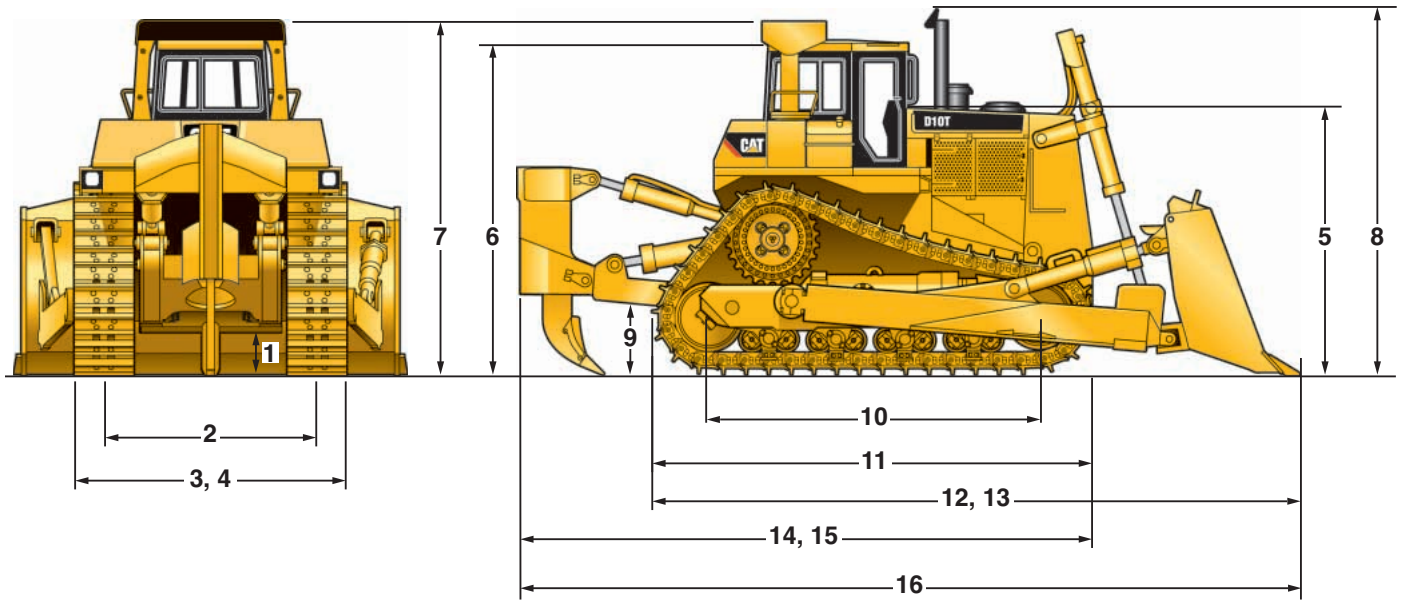

|          |  |         |         |
|----------|--|---------|---------|
| <b>1</b> | Ground Clearance                           | 615 mm  | 24 in   |
| <b>2</b> | Track Gauge                                | 2.5 m   | 100 in  |
| <b>3</b> | Width without Trunnions<br>(Standard Shoe) | 3160 mm | 10.4 ft |
| <b>4</b> | Width Over Trunnions                       | 3716 mm | 12.2 ft |
| <b>5</b> | Height (Stripped Top)                      | 3222 mm | 10.6 ft |
| <b>6</b> | Height (FOPS Cab)                          | 4078 mm | 13.4 ft |
| <b>7</b> | Height (ROPS/Canopy)                       | 4340 mm | 14.2 ft |
| <b>8</b> | Height (Top of Stack)                      | 4543 mm | 14.9 ft |
| <b>9</b> | Drawbar Height<br>(Center of Clevis)       | 779 mm  | 31 in   |

|           |  |         |         |
|-----------|--|---------|---------|
| <b>10</b> | Length of Track on Ground              | 3855 mm | 152 in  |
| <b>11</b> | Length Basic Tractor<br>with Drawbar   | 5331 mm | 17.5 ft |
| <b>12</b> | Length with SU-blade                   | 7500 mm | 24.6 ft |
| <b>13</b> | Length with U-blade                    | 7754 mm | 25.4 ft |
| <b>14</b> | Length with<br>Single-Shank Ripper     | 7091 mm | 23.3 ft |
| <b>15</b> | Length with<br>Multi-Shank Ripper      | 7048 mm | 23.1 ft |
| <b>16</b> | Overall Length<br>(SU-Blade/SS Ripper) | 9260 mm | 30.4 ft |



## Standard Equipment

*Standard equipment may vary. Consult your Caterpillar dealer for details.*

### ELECTRICAL

- Alternator, 95-amp
- Back-up alarm
- Batteries, 12-volt (2), 190 amp-hour
- Converter, 12-volt, 10-amp
- Diagnostic connector
- Horn, forward warning
- Light, engine compartment
- Lighting system, Halogen  
(2 forward, 2 rear)
- Starting receptacle

### OPERATOR ENVIRONMENT

- Advisor-electronic monitoring system
- Armrest, adjustable
- Cab, FOPS
- Controls, electronic implement with lockout
- Decelerator pedal
- Finger Tip Control (FTC) steering
- Engine speed control, electronic
- Hydraulic system, electronically controlled  
for bulldozer and ripper control
- Mirror, rearview
- Radio-ready cab
- Seat, adjustable contour suspension  
(gray fabric)
- Seatbelt, retractable 76 mm (3 in)
- Steps, heavy-duty and Handles
- Wipers, intermittent

### UNDERCARRIAGE

- 610 mm (24 inch) extreme service grouser  
with sealed and lubricated PPR track (44 section)
- Rollers and idlers, lifetime lubricated
- Sprocket rim segments, replaceable
- Suspension-type undercarriage,  
Eight-roller tubular track roller frame
- Track adjusters, hydraulic
- Track guides
- Two-piece master links

### POWER TRAIN

- C27 with ACERT Technology
- 24-volt electric start
- Advanced Modular Cooling System (AMOCS)
- Aftercooler, remote air-to-air
- Air filters, dual with precleaner
- Coolant, extended life
- Directional shift management
- Ether starting aid, automatic
- Fan, suction with hydraulic demand drive
- Fuel priming pump, electric
- Grid, radiator core protection
- Mufflers, dual, with rain cap
- Parking brake
- Prescreener
- Separator, water/fuel
- Thermal shields
- Torque converter
- Transmission, powershift, ECPC, (3F/3R speeds)
- Four planet, double-reduction planetary final drives

### OTHER

- Air conditioner box, corrosive resistant
- Auto-blade assist and AutoCarry ready
- CD ROM parts book
- Ecology drains: engine oil, coolant,  
hydraulic oil, torque divider, fuel tank,  
power train case and transmission
- Engine enclosures
- Guards:
  - Bottom, hinged extreme service
  - Crankcase, hinged extreme service
  - Pivot shaft and seals
  - Radiator, with towing device
- Implement gear pump compatible for Arctic conditions
- Product Link ready
- S•O•S<sup>SM</sup> sampling ports
- Under-hood standard service lamp
- Vandalism, protection (8 caplocks)

## Optional Equipment

*Optional equipment may vary. Consult your Caterpillar dealer for details.*

### ELECTRICAL

- Converter, 24-volt to 12-volt  
additional 15-amp converter
- Lights, supplemental:
  - 6 Halogen
  - 10 Halogen with 2 spot light locations
  - 10 Halogen for mining application
  - 10 Halogen for waste application
  - 11 – 6 Halogen, 5 HID for waste application
  - 11 – 6 Halogen, 5 HID for mining application

### GUARDS

- Dozer lines
- Final drive, clamshell
- Final drive seals
- Idler seal
- Metal hose protective sleeve
- Power train
- Undercarriage

### OPERATOR ENVIRONMENT

- Air conditioner, fender mounted
- Glass, ultra-strength up to 40 psi
- Operators arrangement, modified  
(Improves comfort for smaller operators)
- Seat, air suspension
- Seat, vinyl

### POWER TRAIN

- Fast fuel system
- Quick oil change system
- Prelub, engine

### UNDERCARRIAGE

- Tracks, pair, Sealed and Lubricated:
  - 710 mm (28 in), PPR Extreme Service
  - 800 mm (31.5 in), PPR Extreme Service
- Roller:
  - Carrier rollers, pin-on (one per side)

### SPECIAL ARRANGEMENTS

- Cold Weather arrangement
  - Provides cold weather seals and oils for undercarriage components.
- Mining arrangement and Waste Handling arrangement, in addition to other optional attachments are available from the factory. Contact your Dealer for availability.

### BULLDOZER ATTACHMENTS

- AutoCarry system
- 10SU Blade
- 10SU Blade, abrasion resistant components
- 10U Blade
- 10U Blade, abrasion resistant components
- Dual tilt cylinders

### RIPPERS

- Single-shank\* – Standard depth
- Single-shank\* – Deep ripping (includes pin puller)
- Multi-shank\* (includes one tooth)
- Ripper Attachments:
  - Pin puller (for single-shank ripper)
  - Push block (for single-shank ripper)
  - Additional tooth  
(for multi-shank ripper)

### OTHER ATTACHMENTS

- Counterweights\*:
  - Front mounted
  - Rear mounted
  - Rear mounted (additional)
- Drawbar rigid
- Heater, diesel fuel
- Heater, engine coolant, 120- or 240-volt
- Low temperature start  
(includes two additional heavy-duty batteries and additional starting motor)
- Parts book, paper
- Striker bars, front
- Striker bar, rear – included with rear counterweight
- Winch\* (Dealer Installed)

\* A rear attachment and/or counterweight is recommended for improved performance and balance.

# D10T Track-Type Tractor

For more complete information on Cat products, dealer services,  
and industry solutions, visit us on the web at [www.cat.com](http://www.cat.com)

© 2007 Caterpillar  
All Rights Reserved  
Printed in U.S.A.

Materials and specifications are subject to change without notice.  
Featured machines in photos may include additional equipment.  
See your Caterpillar dealer for available options.

CAT, CATERPILLAR, their respective logos, ACERT, ADEM, "Caterpillar Yellow" and the  
POWER EDGE trade dress, as well as corporate and product identity used herein,  
are trademarks of Caterpillar and may not be used without permission.

AEHQ5592-01 (7-07)

Replaces AEHQ5592

**CATERPILLAR®**