



JOHN DEERE

JD

CONSTRUCTION EQUIPMENT

DOZERS



MODEL NO.

1050C



C-SERIES



BIG DIFFER

JD

CONSTRUCTION EQUIPMENT

DOZERS

MODEL NO.

1050C

FACE

It's not just its size that will make the 42½ ton, 324 horsepower 1050C such a significant addition to your equipment fleet. With full-featured hydrostatic drive-train, John Deere's biggest dozer ever delivers power turns, infinite speed control, counterrotation, and numerous other production-boosting advantages you don't get with other crawlers in its class. Backed by an extensive dealer network and exclusive StructurAll® and worldwide warranties, the 1050C Dozer stands tall on a wide variety of jobsites. To learn more, turn the page.

DRIVETRAIN

Go beyond the limits of other dozers

With their conventional torque converter transmissions and clutch/brake or differential steering systems, other dozers just can't match the 1050C's combination of operating ease and flexibility. Read on and you'll see what we mean.

Instead of a limited gear selection, the 1050C provides an infinitely variable range from 0 to 6.8 mph, giving an operator the freedom to choose the right ground speed for the job.

Power management system takes both the guess and work out of efficient operation. Just set the maximum desired ground speed and the dozer does the rest. As loads change, the drivetrain responds, automatically powering up or down to maintain peak engine rpm and efficiency.





Exclusive Auto-Trac system automatically keeps the 1050C tracking straight in forward or reverse. So your operators concentrate less on making steering corrections. And more on doing their best blade work.

The 1050C steers the same and maintains its preset speed whether it's on level ground or a 2-to-1 slope. And since it won't free-wheel like a torque converter machine, there's no need to cross-clutch or ride a brake.



Infinitely variable track control lets you speed-up or slow power to each track – for smooth, full-power turns that don't tear-up soft terrain like clutch/brake systems.

Unlike dozers with differential steering, the highly maneuverable 1050C makes tight turns at any travel speed.

Harness the power

The image shows the interior of a machine cab, likely for a backhoe loader. The view is from the operator's perspective, looking forward. The cab is filled with yellow seats and a central control panel. The floor is covered with a dark, patterned mat. The overall lighting is dim, with the yellow seats providing a warm glow.

Automatic park brake, slip-resistant floormat, and convenient grab bars help keep your operator out of harm's way.

Decelerator lets you further fine-tune ground speed. Depressing it slows travel while maintaining engine rpm, allowing the 1050C to literally crawl with no loss in hydraulic power. Fully engaging the pedal applies the brakes.

Spacious and quiet walk-through air-conditioned cab is standard. With plenty of tinted glass, all-around visibility is virtually unobstructed.

OPERATOR STATION

Sun in your eyes? Use the roll shade to block it out or to help keep the cab cooler. Wide rear-view mirror is also standard.



Load-sensing hydraulic system delivers precise, low-effort metering to the single lever pilot-operated control. Second lever operates the ripper.

Ground speeds are infinitely variable from 0 to 6.8 mph. A switch on the handle enables an operator to select a specific speed range from a choice of three. 100 percent of available power is always applied regardless of the selected range.



Pilot-operated single lever gives intuitive, low-effort control of steering, forward/reverse travel, and ground speed. The farther you push it ahead or pull it back, the faster you go in that direction.

Deluxe suspension armchair seat fully adjusts for daylong support and comfort. Air suspension power-adjustable seat also available.

Electronic monitor in the right-side console keeps a vigilant watch on machine functions, with warnings you can see and hear. Includes illuminated gauges for engine coolant temperature, engine oil pressure, fuel, and hourmeter.



UNDERCARRIAGE

How the 1050C's DuraTrax undercarriage helps elevate profits

86 inch gauge and 125 inch track length provide solid stability on slopes, ground-gripping traction, and balanced bladework.

Cast steel-alloy segmented sprockets have deep-hardened wear surfaces. Unique tooth profile also helps extend sprocket and bushing life.

No track whipping or chain bunching with the 1050C. What's more, its oval design has only one wear-causing forward-travel flex point. Compared to the three flex points found on elevated sprocket undercarriage, which do you think will last longer?



Deep-hardened, lifetime-lubricated, cast-steel carrier rollers deliver durable, maintenance-free operation.

Hydrostatic drive isn't the only thing that differentiates the 1050C Dozer from others in its class. Its DuraTrax® traditional oval undercarriage design also incorporates numerous advances that help it deliver long life and a smooth ride. Here's why it's the best on any dozer in its class.

8-1/2 inch pitch track links and seven bottom rollers are deep heat-treated through the wear limit for long-term durability. Sealed chain keeps lubricant between pins and bushings in, abrasives out.

Oscillating track frames utilize a unique cushioned pivot shaft that absorbs shock loads for enhanced gradeability and comfort. Heavy-duty pinned crossbar provides 13 inches of track oscillation.

Serious tools for strenuous tasks



Parallelogram ripper's variable pitch shank can be angled on-the-go for optimum power efficiency. Three shank version is also available.

The 1050C was designed with attachments in mind. Rear implement mounting points are built into its mainframe, not bolted-on. Rear counterweight and heavy-duty drawbar are also available.

BLADES/RIPPERS

Whether you're stripping overburden, ripping rock, or muscling through whatever, the 1050C Dozer is up to the task. Both the 12.5 cubic yard semi-U or 15.3 cubic yard U-blades can be armed with hydraulic tilt and power pitch adjustment, plus numerous heavy-duty cutting edges, side cutters, push plates, blade liners, and end bits.

Regardless of which blade you choose, the 1050C's dedicated 89 gpm variable displacement piston pump with load-sensing proportional flow delivers precise metering to the low-effort pilot-operated single lever control.

Rear attachments include single and multi-shank parallelogram rippers with hydraulic pitch adjustment. The single shank rippers' optional pin-puller enables the operator to change shank length at the push of a button from the comfort and safety of the cab.

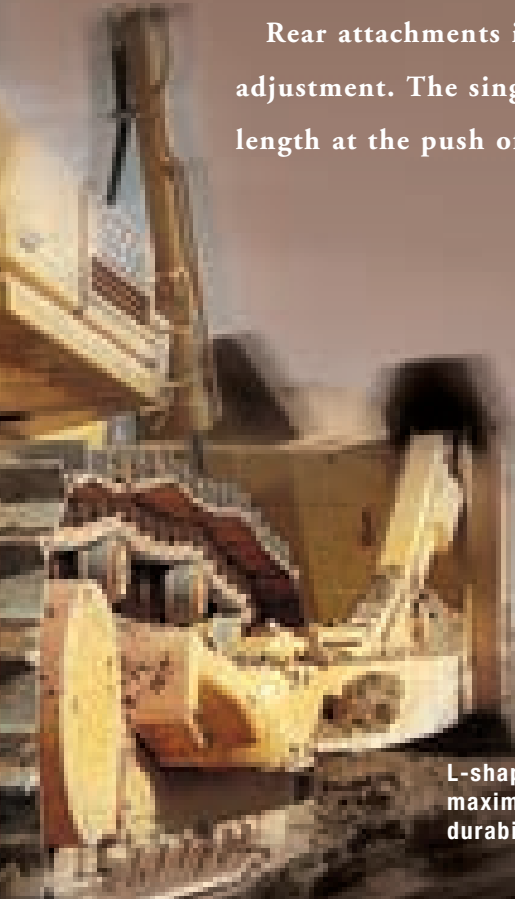

L-shape push beams ensure maximum strength and rigid durability.



Blade pitch is fully adjustable and easily adaptable for top performance in a wide variety of applications and materials.



Heavy-duty sidecutters, steep cutting edge angle, and moldboard curvature get materials rolling to help build and carry big loads. Hardened cutting edges in a variety of thicknesses are available.

SERVICE

Big dozer, minimal maintenance



Lockable service doors provide wide-open access to dipsticks, sight gauges, fill tubes, and filters. Daily drivetrain service can be accomplished on the right side.

Your oilers and service technicians won't have to crawl all over this crawler to maintain it. Like all Deere dozers, daily and periodic service points are conveniently grouped, with many protected behind hinged sideshields that open wide, simplifying fluid and filter checks, additions, and changes.

Master electrical disconnect switch, batteries, and periodic maintenance chart are conveniently located behind the left-side panel.

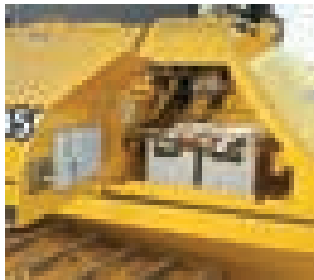

Hydraulically driven cooling fan reduces the load on drive belts for long life.

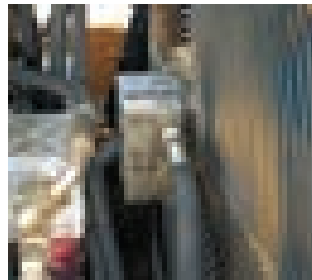

Sight gauges allow a quick visual check of hydraulic/transmission and final drive fluid levels.



Five fin-per-inch radiator core provides efficient cooling, resists plugging, and cleans easily.



Bolt-on rod guides are easy to remove, should cylinder repair ever become necessary.

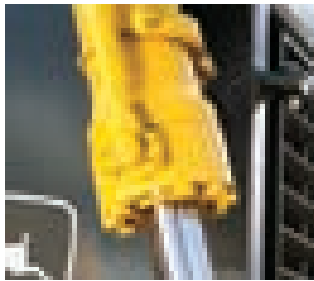

Turbocharged V-6 diesel delivers 324 hp at a slow 1,800 rpm for enhanced longevity and optimum fuel economy. Wet-type cylinder liners dissipate heat for reduced ring wear and oil breakdown.



Final drives incorporate a unique oil-filled double seal. If a failure occurs, the oil escapes, setting off an indicator light on the control panel inside the cab. It's an early-warning system that can help avoid major final drive failures.



Remote diagnostic ports allow quick checks of transmission system and charge pressures for easier troubleshooting.

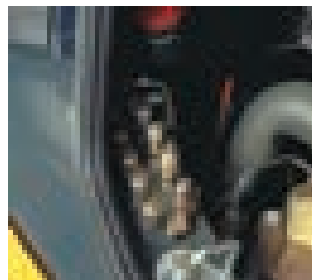

Cab can be tilted in minutes for easier access to the hydrostatic drive motors and the engine. Think of the savings that will make on flat-rate repair costs.

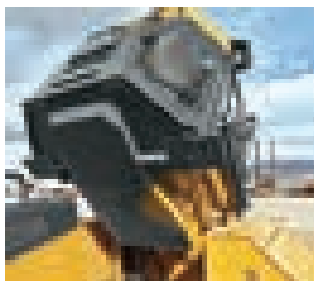

Easily replaced half-shell bearings within the dozer push beams help avoid more costly repairs.

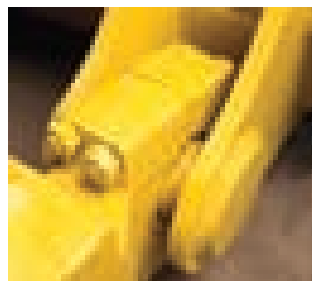

On-site or online, we're at your service

On-site service options and preventive maintenance contracts let you lock-in costs and help avoid downtime by ensuring that critical maintenance work gets done on time, and at your convenience.

CUSTOMER PERSONAL SERVICE



Deere CPS allows you to order parts and gain access to a wealth of technical information and training via the internet.

Got a large equipment fleet? The DeereTrax™ tracking system employs satellite technology to quickly and accurately pinpoint the location of your machines and monitors its hours of operation. It's a valuable maintenance and anti-theft tool that's available for any brand of equipment and your on-highway vehicles, too.

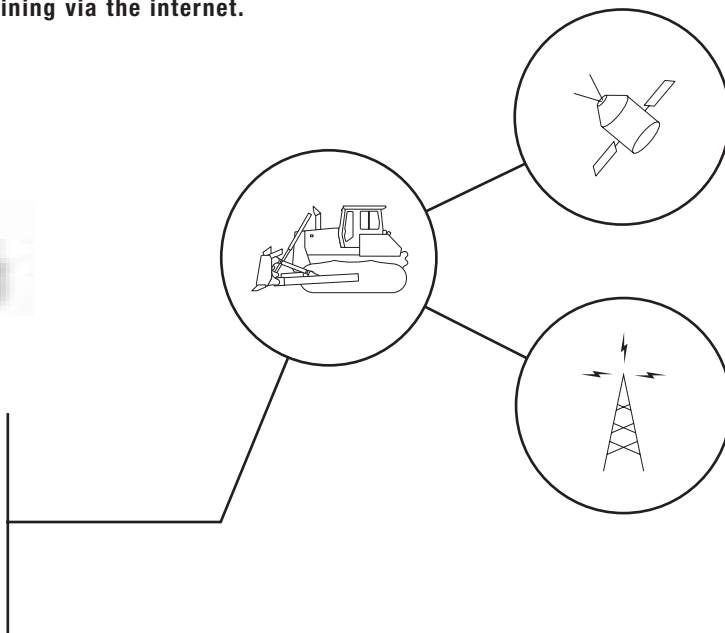

Gone are the days of “one size fits all” parts and service. Instead, John Deere Customer Personal Service (CPS) delivers a new level of customized support.

Under the CPS umbrella is a comprehensive line-up of programs and tools created to serve you and your operation. Employing the internet, satellite, and other state-of-the-art technologies, these initiatives provide split-second answers to technical problems, access to John Deere dealership parts inventories, and even help you keep track of the machines in your fleet.

But CPS isn't just about information. We can also put personnel on your jobsites to handle a wide variety of support needs – from on-site warranty administration, to after-hours fuel and lube, to 24/7 service and maintenance expertise. You tell us how and where we can help make your job easier and we'll put together a plan to make it happen.

1050C

DOZER

SPECIFICATIONS



CONSTRUCTION EQUIPMENT DIVISION

Engine

1050C

Type	Liebherr D 9406 TI-E intercooled and turbocharged diesel
Engine power per ISO 9249.....	324 SAE net hp (242 kW) @ 1,800 rpm
Cylinders (wet sleeve)	V6
Displacement	793 cu. in. (13 L)
Fuel consumption, typical.....	7.7 to 13.2 gal./hr. (29 to 50 L/h)
Maximum net torque.....	1,129 lb.-ft. (1530 Nm) @ 1,200 rpm
Lubrication	pressure system with full-flow spin-on filter and integrated oil-to-water cooler
Air cleaner.....	dual stage dry type with safety element and aspirated precleaner, with dash-mounted restriction indicator
Electrical system.....	24 volt with 55-amp alternator
Cooling fan.....	blower-type, hydrostatically driven, thermostatically controlled
Cold-starting aid.....	flame-glow intake air heater

Transmission

Dual-path, electronic-controlled, closed-loop hydrostatic drive; load-sensing feature automatically adjusts speed and power to match changing load conditions; each individual track is powered by a variable displacement pump and motor combination; single lever controls speed and direction; ground speed (forward and reverse) infinite to 6.8 mph (11 km/h); decelerator pedal permits speed reduction from 6.8 mph (11 km/h) to holding; three working ranges; maximum speed-range control switch located in single-lever handle; maximum speed in range is selected by F-N-R lever position

Travel speeds (infinitely variable)

Forward and reverse speed ranges

1st speed range.....0 to 2.5 mph (0 to 4.0 km/h)

2nd speed range.....0 to 4.0 mph (0 to 6.5 km/h)

3rd speed range.....0 to 6.8 mph (0 to 11.0 km/h)

Final Drives

Heavy-duty, combination spur gear with double-reduction planetary final drives mounted independent of track frame and dozer push frame for isolation from shock loads; the hydraulic drive motors are mounted to the mainframe; final drives are double sealed with electronic seal-integrity indicator

Steering

Fully modulated, infinitely variable, single-lever steering allows for full power turns and counterrotation; infinitely variable track speeds provide unlimited maneuverability and optimum control; hydrostatic steering eliminates steering clutches and brakes

Brakes

Hydrostatic (dynamic) braking stops the machine whenever the direction-control lever is moved to neutral or whenever the combined decelerator/brake pedal is fully depressed

Automatic Park Brake

Exclusive park brake feature engages wet, multiple-disc brakes whenever the engine stops, whenever the combined decelerator/brake pedal is fully depressed, whenever the park lock lever is placed in the start position, whenever the park brake button is pushed on the dash, whenever the F-N-R control is in the neutral position for more than seven seconds, or whenever machine motion is sensed with F-N-R in neutral position; machine cannot be driven with brake applied, reducing wear out or need for adjustment

Hydraulic System

System type	load sensing
Pressure, system relief.....	2,900 psi (20 000 kPa)
Pump type.....	variable-displacement piston pump with load-sensing proportional pump flow control
Flow.....	89 gpm (336 L/min.) @ 1,900 rpm
Filter, return oil.....	20 micron and 5 micron with magnetic particle attractors
Control	single joystick lever
Cylinders.....	heat-treated, chrome-plated, polished cylinder rods with hardened steel pivot pins, replaceable bushings, and bolted rod guides
Hydraulic/transmission cooling fan.....	oil-to-air heat exchanger with hydrostatically driven, thermostatically controlled cooling fan

Capacities (U.S.)

Fuel tank with lockable cap (12-hr. typical usage).....161 gal. (610 L)

Cooling system with recovery tank.....18 gal. (68 L)

Engine oil with spin-on filter.....6.3 gal. (24 L)

Final drive (each).....5.5 gal. (21 L)

Hydraulic/hydrostatic reservoir with filter.....55 gal. (210 L)

Splitter drive.....6.3 qt. (6 L)

All power train and hydraulic systems allow for up to 45-degree maximum operation.

Undercarriage

1050C

Seven-roller track frame with front and rear track guides and sprocket guard; John Deere Dura-Trax™ features deep-heat-treated, sealed, and lubricated track links and through-hardened, sealed, and lubricated rollers for maximum wear resistance; extreme-duty shoes for severe applications

Sprocket.....	segmented
Chain	sealed and lubricated
Track shoes, each side	44
Ground contact area	
22-in. (560 mm) grouser width (extreme duty single bar).....	5,510 sq. in. (35 550 cm ²)
24-in. (610 mm) grouser width (extreme duty single bar).....	6,000 sq. in. (38 700 cm ²)
28-in. (711 mm) grouser width (extreme duty single bar).....	6,990 sq. in. (45 100 cm ²)
Ground clearance, minimum with single-bar grouser (excluding grouser height).....	25 in. (625 mm)
Length of track on ground.....	125 in. (3174 mm)
Track gauge, standard.....	86 in. (2180 mm)
Oscillation at front idler	13 in. (330 mm)
Track rollers, each side	7
Carrier rollers, each side	2
Track pitch	8.5 in. (215 mm)

Ground Pressures

	<i>semi-U dozer blade with power tilt and mechanical pitch adjustment</i>	<i>U blade with power tilt and mechanical pitch adjustment</i>
With standard equipment, full fuel tank, and 175-lb. (79 kg) operator		
With 22-in. (560 mm) extreme-duty single-bar grouser shoes.....	13.4 psi (93 kPa)	13.7 psi (95 kPa)
With 24-in. (610 mm) extreme-duty single-bar grouser shoes.....	12.4 psi (86 kPa)	12.7 psi (88 kPa)
With 28-in. (711 mm) extreme-duty single-bar grouser shoes.....	10.8 psi (74 kPa)	11.0 psi (76 kPa)

SAE Operating Weights

	<i>semi-U dozer blade with power tilt and mechanical pitch adjustment</i>	<i>U blade with power tilt and mechanical pitch adjustment</i>	<i>tractor shipping weight without blade or attachments</i>
With standard equipment, full fuel tank, and 175-lb. (79 kg) operator			
With 22-in. (560 mm) extreme-duty single-bar grouser shoes.....	73,985 lb. (33 560 kg)	75,705 lb. (34 340 kg)	60,580 lb. (27 480 kg)
With 24-in. (610 mm) extreme-duty single-bar grouser shoes.....	74,515 lb. (33 800 kg)	76,235 lb. (34 580 kg)	62,110 lb. (27 720 kg)
With 28-in. (711 mm) extreme-duty single-bar grouser shoes.....	75,525 lb. (34 260 kg)	77,245 lb. (35 040 kg)	62,120 lb. (28 180 kg)

Optional or Special Equipment

Add (+) or deduct (-) lb. (kg) as indicated to base weight for units with

Additional front lights (2)	29 lb. (13 kg)
Auxiliary hydraulics for rear attachment	326 lb. (148 kg)
Full-length rock guards	617 lb. (280 kg)
Heavy-duty cutting edges*	176 lb. (80 kg)
Pin puller for single-shank ripper	106 lb. (48 kg)
Power-pitch push arms with dual-tilt cylinders with hydraulics	650 lb. (295 kg)
Rear counterweight.....	9,261 lb. (4201 kg)
Rigid heavy-duty drawbar	1,460 lb. (662 kg)
Rippers.....	see ripper data, page 19
ROPS canopy	- 850 lb. (- 386 kg)

*Dealer installed.

1050C DOZER WITH BLADE

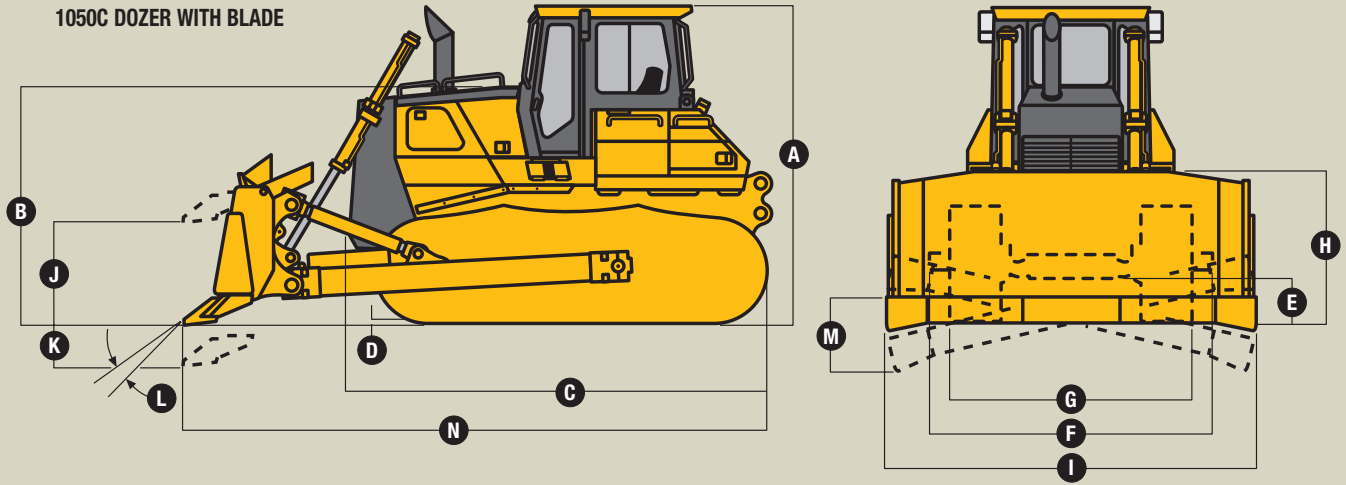

Dimensions

1050C

A Height over cab (including grousers)	143 in. (3640 mm)
B Height over engine cover	107 in. (2725 mm)
C Overall length (without blade)	192 in. (4885 mm)
D Height of grousers	3.3 in. (84 mm)
E Ground clearance	25 in. (625 mm)
F Total width over blade-mounting trunnions	124 in. (3145 mm)
G Overall width	
With 22-in. (560 mm) extreme-duty single-bar grouser shoes	108 in. (2740 mm)
With 24-in. (610 mm) extreme-duty single-bar grouser shoes	110 in. (2790 mm)
With 28-in. (711 mm) extreme-duty single-bar grouser shoes	114 in. (2891 mm)

Blades

semi-U dozer blade with power tilt and mechanical pitch adjustment

U blade with power tilt and mechanical pitch adjustment

Blade weight (including push beams, trunnion mounts, cupped end bits, and tilt cylinder)	13,400 lb. (6080 kg)	15,123 lb. (6860 kg)
Blade capacity	12.5 cu. yd. (9.54 m ³)	15.3 cu. yd. (11.7 m ³)
H Height of blade	65 in. (1650 mm)	65 in. (1650 mm)
I Width of blade	165 in. (4200 mm)	170 in. (4325 mm)
J Lifting height	55 in. (1400 mm)	55 in. (1400 mm)
K Blade digging depth	22 in. (570 mm)	22 in. (570 mm)
L Maximum blade pitch adjustment	10 degrees	10 degrees
M Maximum tilt	39 in. (1000 mm)	40 in. (1025 mm)
N Overall length	252 in. (6415 mm)	272 in. (6915 mm)

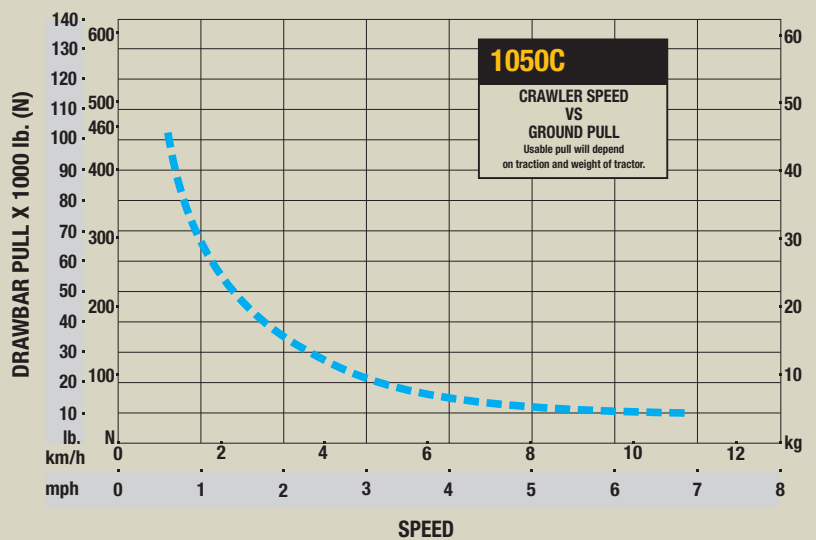
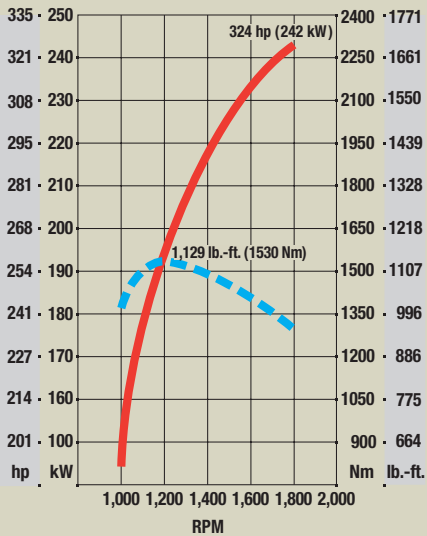

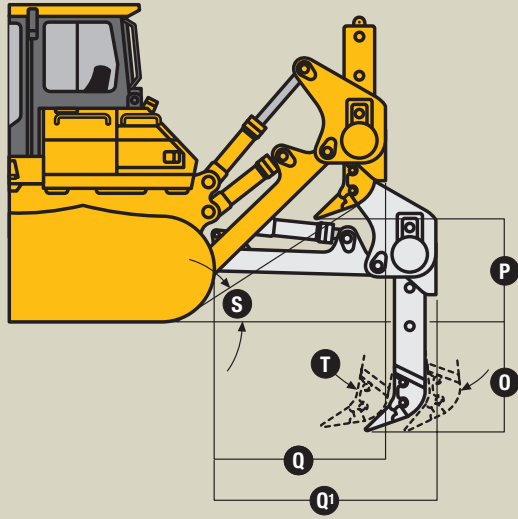

1050C DOZER WITH SINGLE-SHANK PARALLELOGRAM RIPPER

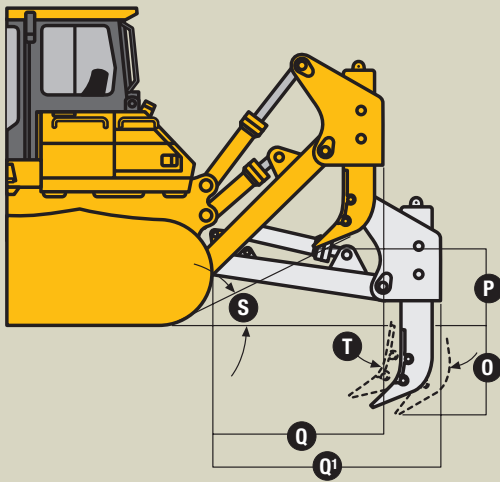
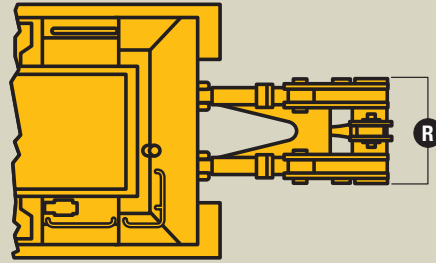

1050C DOZER WITH MULTI-SHANK (3) PARALLELOGRAM RIPPER

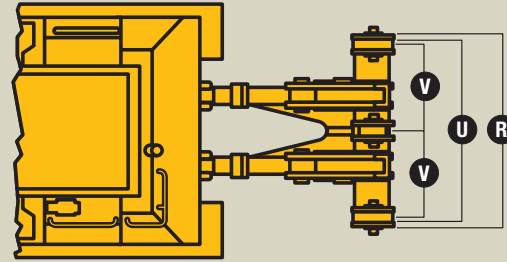

Parallelogram Ripper with Hydraulic Pitch Adjustment and ESCO Ripper Tips

1050C

	<i>single-shank*</i>	<i>multi-shank (3)</i>
Weight	9,390 lb. (4260 kg)	11,800 lb. (5352 kg)
O Maximum penetration	47 in. (1200 mm)	34 in. (855 mm)
P Maximum clearance under tip.....	45 in. (1150 mm)	36 in. (920 mm)
Q Overall length, raised position	74 in. (1880 mm)	74 in. (1880 mm)
Q1 Overall length, lowered position	94 in. (2390 mm)	94 in. (2390 mm)
R Overall beam width	52 in. (1330 mm)	96 in. (2435 mm)
S Slope angle (full raise).....	33 degrees	21 or 29 degrees
T Shank adjustment range	30 degrees	30 degrees
U Ripping width		90 in. (2280 mm)
V Distance between shanks.....		43 in. (1100 mm)

*With hydraulic pin puller.

1050C Dozer

Key: ● Standard equipment ▲ Optional or special equipment

* See your John Deere dealer for further information.

Engine

- 324-hp (242 kW) Liebherr D 9406 T1-E direct-injection, intercooled, turbocharged V6-cylinder diesel (meets EPA off-road emission certification)
- Blower-type cooling fan with hydrostatic drive
- Deep engine oil pan allows up to 45-degree operation
- Dual-element dry-type aspirated air cleaner with automatic dust ejector
- Electric fuel pump
- Enclosed secondary fan guard (conforms to SAE J1308)
- Engine coolant to -34°F (-37°C)
- Fuel system with prefilter, water separator, and microfilters
- Heavy-duty five-fin-per-in. radiator
- Hydraulic engine retarder
- Intake air heater cold-starting aid
- Under-hood muffler with vertical exhaust stack
- Oil-to-water engine oil cooler
- Spin-on full-flow oil filter, with anti-drain back valve
- Starter motor, 8.85 hp (6.6 kW)
- Turbocharger provides spark arresting
- ▲ Cooling fan reverser valve
- ▲ Radiator sand screen

Power Train

- Dual-path hydrostatic transmission: Dynamic braking / Electronically controlled with power management and AutoTrac / Infinite speed control / Inline F-N-R direction control / Single-lever steer with full power turn and counterrotation
- Automatic spring-applied, hydraulic released parking brake
- Hydraulic/transmission oil-to-air cooler, independent of radiator with hydrostatically driven cooling fan
- Park brake button: Neutralizes transmission and activates parking brake
- Three-speed transmission maximum speed control with dash-mounted indicator light
- Transmission system diagnostic test ports

Electrical

- 24-volt system
- Alternator, 55 amp
- Batteries (2), heavy-duty cold start, 1,000 CCA
- Positive battery terminal covers
- Electrically activated battery master disconnect
- Breaker protected circuits
- Working lights, cab mounted, front (4) and rear (2)
- ▲ Additional grille or cylinder-mounted front lights (2)
- ▲ Additional rear lights (2)

Hydraulic System

- 89-gpm (336 L/min.) load-sensing variable-displacement pump
- Blade quick-drop valve
- Circuit relief valve protection
- Hydraulic functions disabled with park lock lever
- Hydraulic/hydrostatic oil reservoir with sight glass
- Hydraulic system diagnostic test port
- "O"-ring seal connectors
- Replaceable filter, 20/5 micron with magnetic particle attractors
- Single-lever control
- Tank shutoff valves for service
- Two-function single-lever dozer-control valve
- ▲ Hydraulic controls for dual tilt and power pitch
- ▲ Hydraulic controls for rear attachments

Undercarriage

- 86-in. (2180 mm) gauge standard track frame
- Center track guides
- Front idler and sprocket chain guides
- Hydraulic track adjusters with dirt cover
- Oscillating track frames
- Integral track frame covers
- Isolation-mounted pivot shafts and equalizer bar
- Maintenance-free track components, sealed and lubricated rollers, idlers, and sprockets
- Sealed and lubricated track chain
- Segmented bolt-on sprockets
- 22-in. (560 mm) extreme-duty single-bar grouser shoes
- ▲ 24-in. (610 mm) extreme-duty single-bar grouser shoes
- ▲ 28-in. (711 mm) extreme-duty single-bar grouser shoes
- ▲ Full-length bolt-on rock guards

Operator's Station

- Modular cab with integrated ROPS/FOPS (conforms to SAE J1040, ISO 3471/3449): Hydraulically tiltable rearward 40 degrees / Isolation mounted / Air conditioner/heater/defroster/pressurizer with filtered fresh air intake and three-speed blower / Ashtray / Dome light / Fabric seat cushions / Lockable doors (open and closed position) / Pull-down sunshade / Radio-installation provision / Rearview mirror / Sliding left-hand window / Tinted glass / Windshield wipers, front and rear, with washers
- ▲ Modular ROPS/FOPS canopy, isolation mounted, vinyl seat cushions (conforms to SAE J1040, ISO 3471/3449)
- Left and right access
- Built-in operator's manual storage compartment and operator's manual
- Rubber floor mat
- Deluxe mechanical suspension seat: Adjustable armrests, backrest, height/weight, and fore-aft / Seat cushion tilt

Operator's Station (continued)

- ▲ Deluxe air suspension power-adjustable seat (cab only): Adjustable armrests, backrest, height/weight, and fore-aft / Fabric seat cushions / Seat cushion tilt
- Seat belt, 2-in. (50 mm), retractable (conforms to SAE J386)
- ▲ Seat belt, 3-in. (76 mm), retractable with CRS (conforms to SAE J386)*
- 15-degree seat angle
- Electronic monitor system with audible and visual warnings: Engine air filter restriction / Final drive seal integrity / Hydraulic/hydrostatic filter restriction / Hydrostatic transmission pressure / Low alternator voltage / Park brake
- Gauges, electric, illuminated: Engine coolant temperature / Engine oil pressure / Fuel / Hourmeter
- Horn, electric
- Key start switch with electric fuel shutoff
- 24-volt power port
- Lever-controlled throttle
- Slip-resistant steps and ergonomically located handholds
- ▲ Radio AM/FM*

Attachments

- ▲ 165-in. (4191 mm) semi-U blade, 12.5-cu. yd. (9.5 m³), with standard cutting edges
- ▲ 170-in. (4318 mm) U-blade, 15.3-cu. yd. (11.7 m³), with standard cutting edges
- ▲ 198-in. (5030 mm) mechanical-angle blade, 8.2-cu. yd. (6.3 m³), with standard cutting edges*
- ▲ Heavy-duty cutting edges*
- ▲ Push beam for semi-U or U-blade with hydraulic tilt and manual pitch adjustment
- ▲ Push beam for semi-U or U-blade with two tilt cylinders for dual tilt and power pitch
- ▲ Push plates, blade liners, and end bits*
- ▲ Single-shank parallelogram ripper
- ▲ Multi-shank (3) parallelogram ripper
- ▲ Hydraulic pin puller for single-shank ripper
- ▲ Rear counterweight, 9,240 lb. (4200 kg), with drawbar (cannot be used with rippers)
- ▲ Rigid heavy-duty drawbar (cannot be used with rear counterweight or rippers)

Overall Vehicle

- 161-gal. (610 L) fuel tank with wide-mouth filler cap
- Hinged reinforced radiator guard
- Lifting lugs
- Lockable vandal protection: Battery compartment / Engine access doors / Fuel tank / Hydraulic and transmission access door / Instrument panel (canopy only) / Storage compartments (2)
- One-piece unitized mainframe
- Rear retrieval hitch
- Reinforced engine bottom guards
- Reverse warning alarm (conforms to SAE J994, J1446)
- Tool kit with brake-release towing kit



JOHN DEERE

Net engine power is with standard equipment including air cleaner, exhaust system, alternator, and cooling fan, at standard conditions per SAE J1349 and DIN 6270B, using No. 2-D fuel at 35 API gravity. No derating is required up to 10,000-ft. (3050 m) altitude.

Specifications and design subject to change without notice. Wherever applicable, specifications are in accordance with SAE standards. Except where otherwise noted, these specifications are based on a unit with modular ROPS/cab with air conditioning, 165-in. (4191 mm) semi-U blade with standard cutting edges, full fuel tank, 175-lb. (79 kg) operator, and standard equipment.

