

390D/390D L

Hydraulic Excavators



Engine

Engine Model	Cat® C18 ACERT® (ATAAC)
Net Power – ISO 9249	390 kW (523 hp)
Net Power – SAE J1349	390 kW (523 hp)

Drive

Maximum Travel Speed	4.5 km/h
Maximum Drawbar Pull	590 kN

Weights

Operating Weight – Long Undercarriage	86 190 kg
• 8.4 m GP boom, R4.4 m stick, 4.6 m ³ HD bucket and 650 mm shoes.	

Features

Performance

High level of sustained production, improved performance, reliability and durability increase your productivity and lower your operating costs.

Engine

The Cat® C18 engine uses ACERT™ Technology for exceptional performance capabilities and proven reliability.

Operator Station

Superior cab comfort and visibility provide an excellent working environment. The full-color monitor with graphic display features enhanced functionality to provide a simple, comprehensive machine interface.

Maximum Versatility

A variety of work tools, including buckets, are available for applications such as demolition, site clean-up, scrap processing, breaking up road surfaces and bedrock through Cat® Work Tools.

Service and Maintenance

Fast, easy service has been designed in with long service intervals, advanced filtration, convenient filter access and user-friendly electronic diagnostics for increased productivity and reduced maintenance costs.

Contents

Hydraulics	3
Operator Station.....	4
Engine	5
Control System	6
Structures.....	7
Undercarriage	8
Front Linkage	9
Buckets and Teeth	10
Work Tools.....	11
Environment.....	12
Service and Maintenance	13
Complete Customer Support.....	14
Hydraulic Excavator Specifications	15
Standard Equipment.....	30
Optional Equipment.....	31



The Cat® 390D/390D L Hydraulic Excavator has excellent control, high stick and bucket forces, impressive lift capacity, simplified service and a comfortable operator station to increase your productivity and lower operating costs.

Hydraulics

Precise power and control to move more material

Main Pumps

The hydraulic system includes three pumps with an independent swing circuit. The hydraulic circuit utilizes a load-sensing system to ensure high efficiency and productivity with little hydraulic loss.

Swing Dampening Valve

A swing dampening valve reduces wagging, which produces smoother, time-saving swing stops.

Implement Pressure

Increased implement pressure provides shorter cycle times, stronger digging forces and greater bucket fill factors.

Auxiliary Hydraulics

Standard auxiliary hydraulics are managed electronically, making the machine more versatile.

Proportional Priority Pressure Compensation (PPPC) Hydraulics

The load-sensing PPPC system with proprietary electronic actuation provides excellent efficiency and controllability.

- Pump discharge flow matches the operator's desired speed, which makes for extremely smooth shifting from neutral to full stroke.
- Pump flow volume all goes to the actuator, which ensures the delivery of maximum hydraulic energy. Even if load pressure changes during actuation, the control lever position does not vary, which makes for consistent, reliable operation.



Operator Station

Simple and comfortable for maximum productivity



Cab Design

The spacious cab provides excellent visibility and ergonomics. The full-color monitor provides the operator with easy-to-read, comprehensive machine information.

Cab Exterior

The cab utilizes thick steel tubing along the bottom to reduce vibration and fatigue. The cab structure allows the FOGS to be bolted directly to the cab either at the factory or as an attachment.

Cab Mounts

The cab shell is attached to the frame with viscous rubber cab mounts, which dampen vibrations and sound levels to enhance operator comfort.

Additional Features

The 390D operator station has many features for operator comfort.

- Low effort joysticks.
- Numeric view of fuel consumption on the monitor.
- Optional rearview camera for added safety.
- Optional HID (High Intensity Discharge) lights with time delay for the boom and cab lights.
- Optional premium air suspension seat with adjustable/tilt console.
- Two-way radio-ready option.



Engine

Power to move more dirt with less fuel

Cat® C18 Engine

The C18 engine with ACERT™ Technology powers the 390D. The C18 has a proven record of long life. Materials like high-strength steels and cast iron contribute to its durability, while uniquely designed water-cooled turbochargers and mechanically actuated fuel injection contribute to its reliability.

Improved Fuel Efficiency

The 390D optimizes fuel consumption through flexible power settings incorporated into the ADEM™ controller, which electronically manages engine response to load demand. The operator can select High Production, Standard or Economy mode to meet application requirements.

Hydraulic Cooling Fans

The 390D uses hydraulically driven cooling fans that operate based on coolant and hydraulic oil temperatures. To reduce load when cranking the engine, the cooling fan speed is fixed for a set amount of time after the engine is started and then is increased gradually to a specific speed.

Reversible Fan

A reversible fan option is offered to help clean the cooling package for increased uptime and reduced service cost.

Control System

Easy to view, easy to manage



Monitor Display

The monitor is a full-color Liquid Crystal Display (LCD). A master caution lamp blinks ON and OFF when one of the critical conditions below occurs:

- Engine oil pressure low
- Coolant temperature high
- Hydraulic oil temperature high

Under normal conditions or the default condition, the monitor display screen is divided into four areas: clock and throttle dial, gauge, event display and multi-functional display.

Gauge Display

Three analog gauges – fuel level, hydraulic oil temperature and coolant temperature – are displayed in this area.

Pattern Control Changer

The standard hand control pattern changer can be accessed through the monitor to utilize either the standard excavator control pattern or backhoe pattern, making it easier for operators to work in the mode they are accustomed.

Electronic Joysticks

Electronic joysticks provide features not possible with hydraulic pilot valves:

- Eliminate pilot lines in cab for quieter operation
- Simple pattern change through the monitor

Operator Gain/Response

This is used to suit the operator preference or application.

- Faster for quick response
- Slower for more precision

Product Link

Product Link is a proprietary Caterpillar technology that tracks machine location, product health, hours of use and fuel consumption. This information is transmitted back to customers to help maximize machine productivity.

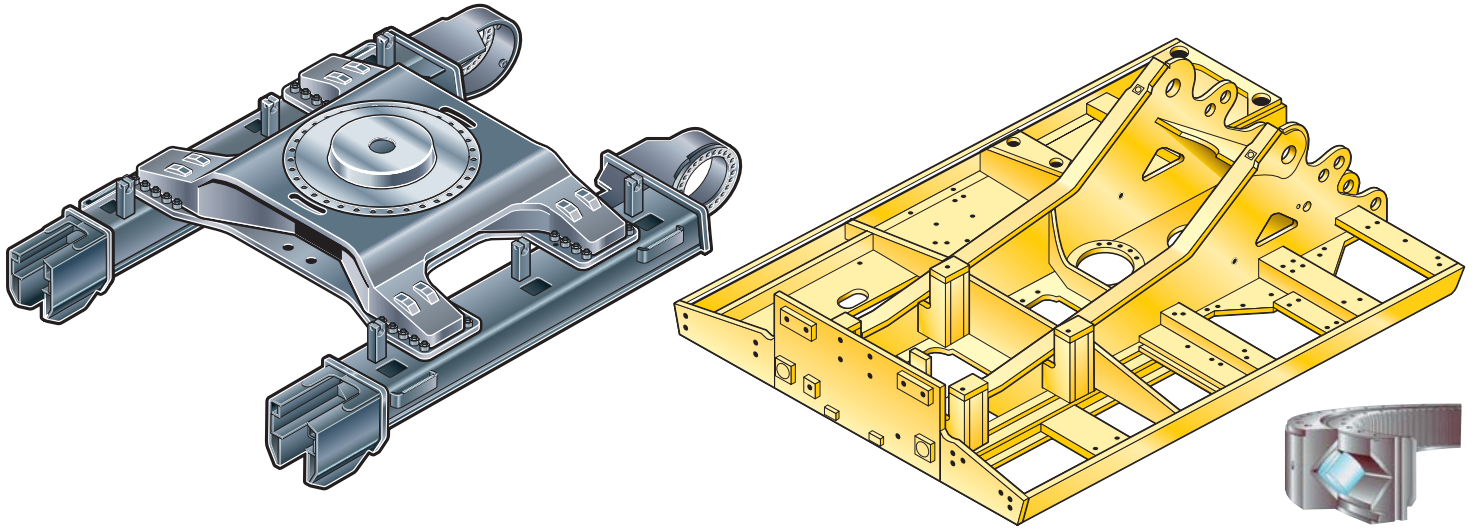

Structures

Rugged and durable for many applications

Variable Gauge Undercarriage

The variable gauge undercarriage is standard, providing a wide, stable base for operating or a narrow gauge for reduced shipping width. Changes to the 390D/390D L undercarriage include:

- Improved track link to reduce and avoid stresses
- Improved carrier rollers to reduce the risk of leaking lubrication oil
- Improved forged idler for added durability in severe underfoot conditions
- Positive Pin Retention 2 (PPR2) to prevent pin movement

Catwalks

Slip-resistant catwalks are 500 mm wide and stretch the length of the machine to provide safe access to major service points.

Track Roller Frame

The thick, steel-plated track roller frame is welded into a box structure, which provides increased rigidity and impact resistance.

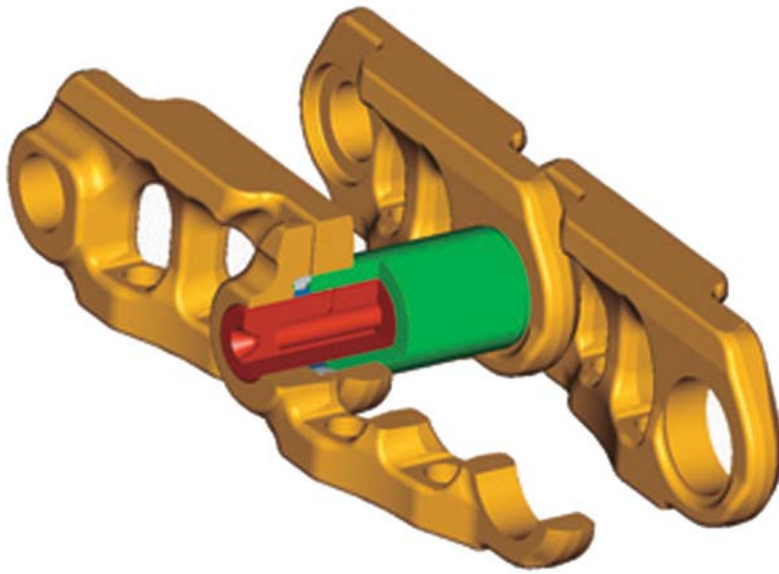

Undercarriage

Strong, stable and durable

Undercarriage

The undercarriage supports the swing bearing and upper structure and is the link that transmits the reaction forces from digging to the ground. The strength of the Cat undercarriage plays a major factor in machine stability and durability.

Track Roller Frame

The track roller frame has been improved by installing a longer stroke recoil spring and lowering the front idler. The longer recoil spring improves durability and service life of the undercarriage while the offset idler increases the stability of the machine while working over the front.

Positive Pin Retention 2 (PPR2)

Track links with the PPR2 are provided as standard on the 390D/390D L. The PPR2 is designed to prevent looseness of the track pin in the track link and to reduce stress concentrations. The PPR2 system eliminates pin movement for increased service life.

Carrier Rollers

The carrier rollers use a floating Duo-Cone seal, which reduces the risk of leaking lubricating oil.

Forged Idler

A forged idler for increased durability is standard on the 390D/390D L.

Front Linkage

Built to perform the toughest tasks

Front Linkage

Cat® Excavator booms and sticks are built for performance and long service life.

- Casting and forgings are used at high stress areas such as the boom nose, boom foot, boom cylinder and stick foot.
- All booms and sticks are stress-relieved for optimal life and durability while minimizing weight for improved performance.
- All booms and sticks are ultrasonic inspected to ensure reliability.

Bucket Linkage

Two bucket linkages are available for the 390D.

Boom Construction

390D booms feature a large cross section to improve strength, reduce weight and maximize payload. Baffle plates reinforce the boom interior for higher rigidity.

Stick Construction

Sticks are made of high-tensile strength steel in a box-section design, making them strong and light. All sticks are reinforced with a thick baffle plate for added rigidity. The connection between stick and boom is made of forged steel, and a thick steel plate is used at the bucket connecting location for increased strength and rigidity at load-bearing points. An additional wear plate is added to the bottom plate to protect against damage. There are two reach sticks, three general purpose sticks and two mass sticks available to meet your needs.

Linkage Pins

All front linkage pins have thick chrome plating, giving them high wear resistance. Each pin diameter is made to distribute the shear and bending loads associated with the stick and to help ensure long pin, boom and stick life.

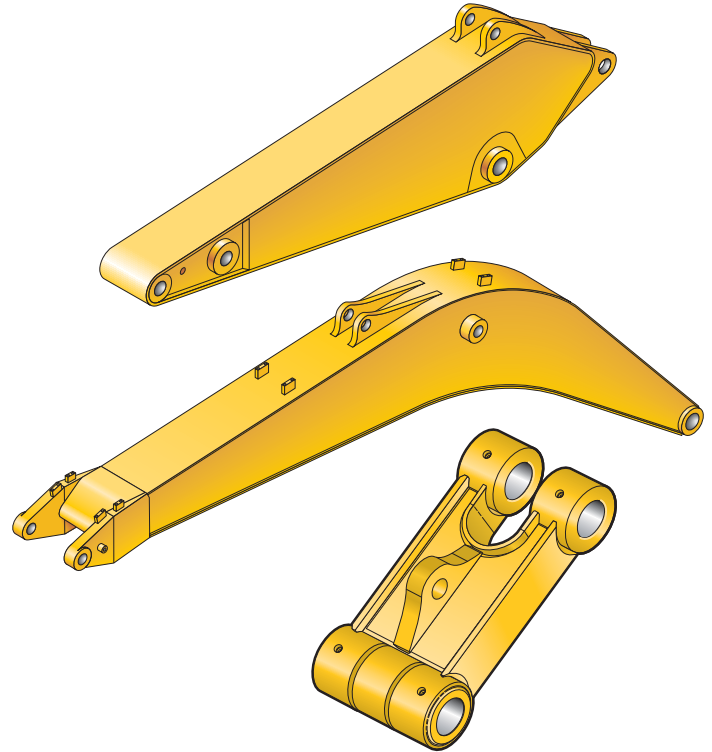

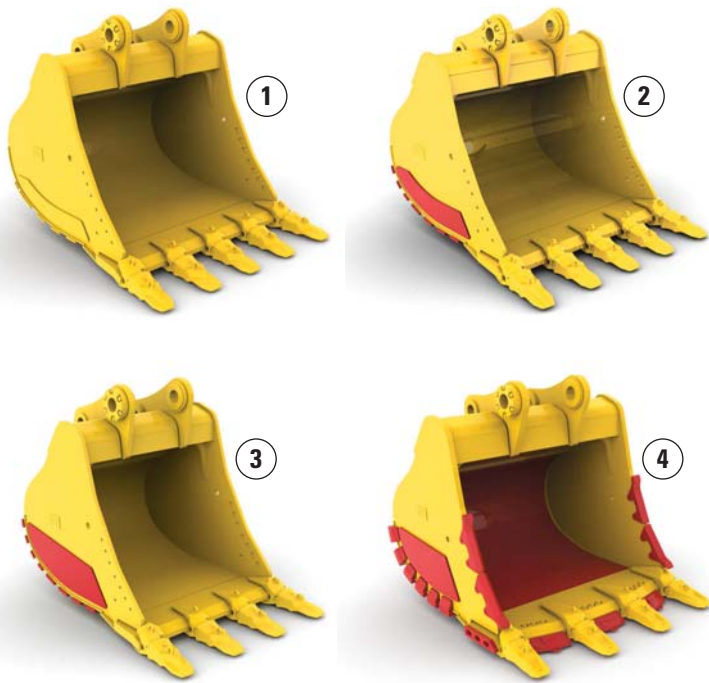

Buckets and Teeth

Designed and built for rugged work

Optimized Package

Caterpillar offers a wide range of buckets – each designed and field tested to function as an integral part of your excavator. All Cat® Buckets feature K Series™ Ground Engaging Tools (GET). Buckets are available in four levels of durability and are built to take full advantage of the machine's power.

General Duty (GD)

General Duty buckets are designed for use in low impact, low abrasion material such as dirt, loam and mixed compositions of dirt and fine gravel.

Heavy Duty (HD)

Heavy Duty buckets are the most popular and a good “centerline” choice. This bucket style is a good starting point when application conditions are not known. Heavy Duty buckets are designed for a wide range of impact and abrasion conditions, including mixed dirt, clay and rock.

Severe Duty (SD)

Severe Duty buckets are designed for higher abrasion conditions such as shot granite. When compared to the Heavy Duty bucket, wear bars and wear plates are substantially thicker and larger for added protection.

Extreme Duty (XD)

Extreme Duty buckets are designed for very high abrasion conditions such as granite quarries. Corner shrouds have been added, and side wear plates are larger for added protection.

1) Severe Duty 2) Heavy Duty 3) General Duty 4) Extreme Duty

Work Tools

Solutions for many applications

Increase Machine Versatility

The Cat combination of machine and tool provides a total solution for just about any application. Work tools can be mounted either directly to the machine or to a quick coupler, making it fast and easy to release one work tool and pick up another.

Quick Coupler

Cat quick couplers enable the operator to simply release one work tool and pick up another so your hydraulic excavator becomes extremely versatile.

Work Tools

An extensive range of Cat Work Tools for the 390D includes buckets, grapples, shears, multi-processors and rippers. Each is designed to optimize the versatility and performance of your machine. Cat Work Tools and couplers are ready to work in a variety of applications, such as site and structure demolition, debris clean-up, truck loading, scrap processing and breaking road surfaces and bedrock.

Hydraulic Kits

Caterpillar offers field-installed hydraulic kits designed to simplify the process of ordering and installing the right kit. Modular kit designs integrate Cat Work Tools with Cat Hydraulic Excavators. Every kit is easy to install. Hoses are pre-made, tubes are pre-bent and pre-painted and there are comprehensive instructions.





Environment

Built to meet a range of requirements

Emissions

ACERT™ Technology is a differentiated technology that reduces emissions at the point of combustion. It capitalizes on proven Caterpillar leadership in three core engine systems: fuel, air and electronics.

Electro Magnetic Compliance

The 390D meets the following EMC (Electro Magnetic Compliance) requirements:

- ISO 13766 Earth Moving Machinery – Electromagnetic compliance
- EU Directive 89/336/EEC
- Aus EMC Framework

Fluid Management

Many serviceability elements are designed into the 390D to limit fluid spillage while performing routing maintenance.

Filters

Hydraulic return filters are vertically mounted, capsule-type with shutoffs in the inlet and outlet ports.

Ecology Drains

Ecology drains for the fuel and hydraulic tanks allow fluids to be captured in a container when draining the tanks.

Certified Rebuild

When most other manufacturers' models require replacement, Cat equipment can be rebuilt using many remanufactured parts. This means less materials going to landfills.

Service and Maintenance

Fast, easy and safe access is built in

Service Intervals

Long service intervals reduce maintenance costs. Engine oil, oil filter and fuel filters are rated at 500 hours.

Oil Sample and Pressure Ports

Oil sample and pressure ports provide easy checking of machine condition and are standard on every machine.

Hydraulic Capsule Filters

The return filters, or capsule filters, for the hydraulic system are located beside the hydraulic tank. The filter elements are removable without spilling hydraulic oil.

Service Points

Service points are centrally located with easy access to facilitate routine maintenance.

Pilot Hydraulic System Filter

A pilot hydraulic system filter keeps contaminants from the pilot system and is located in the pump compartment.

Remote Greasing Block

A concentrated remote greasing block on the boom delivers grease to hard-to-reach locations.

Radial Seal Cleaner

The radial seal main air cleaner with precleaners has a double-layered filter element for more efficient filtration. No tools are required to change the element.

Fuel-Water Separator

The fuel-water separator removes water from fuel, even when under pressure, and the water level can be monitored in the cab.



Complete Customer Support

Cat® dealer services to help you operate longer with lower costs



Product Support

Cat dealers utilize a worldwide parts network to minimize machine downtime. Plus you can save money with Cat remanufactured components.

Machine Selection

Make detailed comparisons of machines you are considering. What are the job requirements and machine attachments? What production is needed? Your Cat dealer can provide recommendations.

Purchase

Consider financing options and day-to-day operating costs. Look at dealer services that can be included in the machine's cost to yield lower owning and operating costs over time.

Customer Support Agreements

Cat dealers offer a variety of customer support agreements and work with you to develop a plan to meet specific needs. These plans can cover the entire machine, including attachments, to help protect your investment.

Operation

Improving operating techniques can boost your profits. Your Cat dealer has videos, literature and other ideas to help you increase productivity. Caterpillar also offers simulators and certified operator training to help maximize the return on your investment.

Replacement

Repair, rebuild or replace? Your Cat dealer can help you evaluate the cost involved so you can make the right choice.

390D/390D L Hydraulic Excavator Specifications

Engine

Engine Model	Cat® C18 ACERT® (ATAAC)
Net Power – ISO 9249	390 kW (523 hp)
Net Power – SAE J1349	390 kW (523 hp)
Net Power – EEC 80/1269	390 kW (523 hp)
Bore	145 mm
Stroke	183 mm
Displacement	18.1 L

- The 390D meets worldwide emission requirements.
- No engine power derating required below 2300 m altitude.
- Net power advertised is the power available at the flywheel when the engine is equipped with fan, air cleaner, muffler and alternator.

Weights

Operating Weight – Long Undercarriage	86 190 kg
---------------------------------------	-----------

- 8.4 m GP boom, R4.4 m stick, 4.6 m³ HD bucket and 650 mm shoes.

Track

Number of Shoes (each side) – Long Undercarriage	51
Number of Track Rollers (each side)	9
Number of Carrier Rollers (each side)	3

Swing Mechanism

Swing Speed	6.2 rpm
Swing Torque	260 kN·m

Drive

Maximum Travel Speed	4.5 km/h
Maximum Drawbar Pull	590 kN

Hydraulic System

Main System – Maximum Flow (Total)	980 L/min
Swing System – Maximum Flow	460 L/min
Maximum Pressure – Equipment – Normal	35 000 kPa
Maximum Pressure – Travel	35 000 kPa
Maximum Pressure – Swing	26 000 kPa
Pilot System – Maximum Flow	90 L/min
Pilot System – Maximum Pressure	4120 kPa
Boom Cylinder – Bore	210 mm
Boom Cylinder – Stroke	1967 mm
Stick Cylinder – Bore	220 mm
Stick Cylinder – Stroke	2262 mm
HB2 Family Bucket Cylinder – Bore	200 mm
HB2 Family Bucket Cylinder – Stroke	1451 mm
JC Family Bucket Cylinder – Bore	220 mm
JC Family Bucket Cylinder – Stroke	1586 mm

Service Refill Capacities

Fuel Tank Capacity	1240 L
Cooling System	101 L
Engine Oil	65 L
Swing Drive (each)	19 L
Final Drive (each)	21 L
Hydraulic System (including tank)	995 L

Sound Performance

Performance	ANSI/SAE J1166 OCT98
-------------	----------------------

- Operator Sound – The operator sound level measured according to the procedures specified in ISO 6394:1998 is 85 dB(A), for cab offered by Caterpillar, when properly installed and maintained and tested with doors and windows closed.
- Exterior Sound – The labeled spectator sound power level measured according to the test procedures and conditions specified in 2000/14/EC is 108 dB(A).
- Hearing protection may be needed when operating with an open operator station and cab (when not properly maintained or doors/windows open) for extended periods or in a noisy environment.

Standards

Brakes	SAE J1026 APR90
Cab/FOGS	SAE J1356 FEB88/ISO 10262

- ISO 10262 OPS, front and top
- ISO J1356 FOGS, front and top

390D/390D L Hydraulic Excavator Specifications

Dimensions

All dimensions are approximate

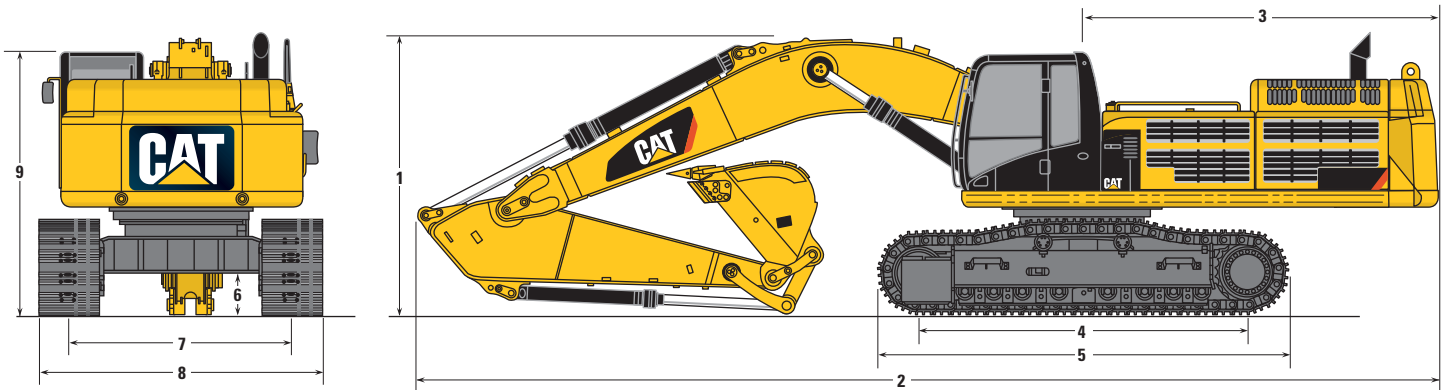

Stick	Reach Boom 10.0 m		General Purpose Boom 8.4 m			Mass Boom 7.25 m		
	R5.5 m	R4.4 m	R5.5 m	R4.4 m	GP2.92 m	M3.4 m	M2.92 m	
Bucket	HB3.9 m ³	HB3.9 m ³	HB4.6 m ³	HB4.6 m ³	JC4.6 m ³	JC6.0 m ³	JC6.0 m ³	
1 Shipping Height	mm	5430	5030	5840	5290	4970	5310	4900
2 Shipping Length	mm	16 280	16 320	14 490	14 700	14 910	13 560	13 690
3 Tail Swing Radius	mm	4680	4680	4680	4680	4680	4680	4680
4 Length to Center of Rollers***	mm	5120	5120	5120	5120	5120	5120	5120
5 Track Length****	mm	6360	6360	6360	6360	6360	6360	6360
6 Ground Clearance	mm	900	900	900	900	900	900	900
7 Track Gauge (Shipping)*	mm	2750	2750	2750	2750	2750	2750	2750
8 Transport Width**	mm	4260 (LC)	4260 (LC)	4260 (LC)	4260 (LC)	4260 (LC)	4260 (LC)	4260 (LC)
9 Cab Height	mm	3760	3760	3760	3760	3760	3760	3760

* Track gauge in extended (working) position: 3510 mm.

** Transport width shown for 750 mm.

Add 150 mm for 900 mm shoes.

Subtract 100 mm for 650 mm shoes.

*** STD 4600 mm (STD), 5120 mm (LC).

**** STD 5840 mm (STD), 6360 mm (LC).

Working Ranges

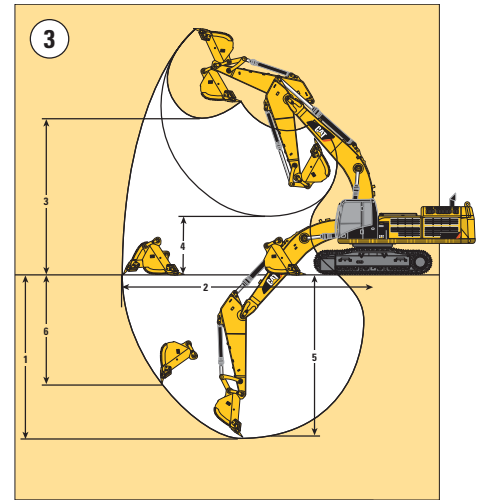
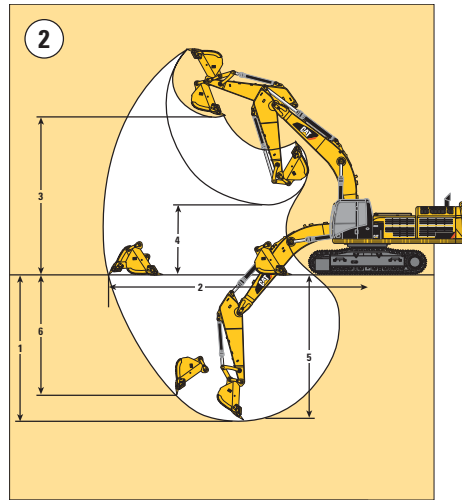
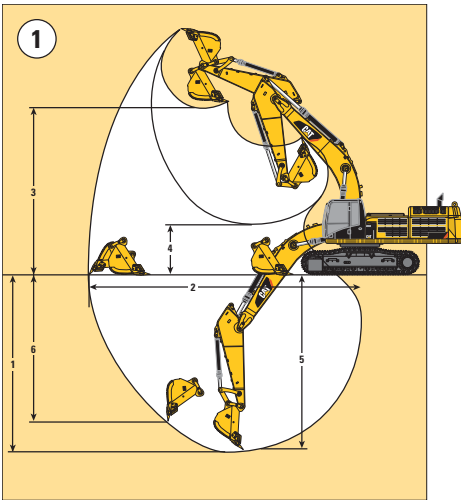

		① Reach Boom 10.0 m		② General Purpose Boom 8.4 m			③ Mass Boom 7.25 m		
Stick		R5.5 m	R4.4 m	R5.5 m	R4.4 m	GP2.92 m	M3.4 m	M2.92 m	
Bucket		HB3.9 m ³	HB3.9 m ³	HB4.6 m ³	HB4.6 m ³	JC4.6 m ³	JC6.0 m ³	JC6.0 m ³	
1	Maximum Digging Depth	mm	11 810	10 710	10 760	9660	8220	7650	7170
2	Maximum Reach at Ground Line	mm	17 250	16 230	15 730	14 690	13 480	12 690	12 240
3	Maximum Loading Height	mm	10 950	10 520	9720	9270	8910	8200	7980
4	Minimum Loading Height	mm	3310	4410	1940	3040	4480	3200	3670
5	Maximum Depth Cut for 2240 mm Level Bottom	mm	11 710	10 600	10 660	9550	8080	7520	7030
6	Maximum Vertical Wall Digging Depth	mm	8390	7380	7860	6850	5950	5100	4700
Bucket Digging Force									
	(SAE)	kN	322	321	322	321	411	404	404
	(ISO)	kN	365	363	365	363	470	471	470
Stick Digging Force									
	(SAE)	kN	230	268	230	268	337	314	342
	(ISO)	kN	236	276	236	276	350	325	356

390D/390D L Hydraulic Excavator Specifications

Operating Weight* and Ground Pressure

	Track					
	900 mm Shoes		750 mm Shoes		650 mm Shoes	
	kg	kPa	kg	kPa	kg	kPa
Reach Boom – 10.0 m						
Bucket – 3.9 m ³						
R5.5 m	90 070	88.3	88 950	104.7	88 080	119.6
R4.4 m	89 570	87.8	88 450	104.1	87 580	118.9
General Purpose Boom – 8.4 m						
Bucket – 4.6 m ³						
R5.5 m	88 690	87.0	87 570	103.1	86 690	117.7
R4.4 m	88 180	86.5	87 070	102.5	86 190	117.1
GP2.92 m	90 680	88.9	89 570	105.4	88 690	120.4
Mass Boom – 7.25 m						
Bucket – 6.0 m ³						
M3.4 m	92 380	90.6	91 260	107.4	90 390	122.7
M2.92 m	92 130	90.4	91 010	107.1	90 140	122.4

* Operating weight includes full fuel tank and 75 kg operator.

Major Component Weights

	kg
Base machine with counterweight and 750 mm shoes (without front linkage)	67 950
Two boom cylinders	1720
Counterweight – GP	
Removal type	12 410
Non-removal type	12 410
Boom (includes lines, pins, stick cylinder)	
Reach Boom – 10.0 m	9750
General Purpose Boom – 8.4 m	8310
Mass Boom – 7.25 m	8480
Stick (includes lines, pins, bucket cylinder and linkage)	
R5.5 m	5430
R4.4 m	4930
GP2.92 m	4910
M3.4 m	5420
M2.92 m	5170

390D Reach Boom Lift Capacities



Load Point Height



Load at Maximum Reach



Load Radius Over Front



Load Radius Over Side

Boom – 10.0 m

Coupler – N/A

Bucket – None

Stick – R5.5 m

Shoes – 750 mm double grouser

Load Point Height	kg	3.0 m		4.5 m		6.0 m		7.5 m		9.0 m		10.5 m		12.0 m		13.5 m		15.0 m		m				
		Front	Side	Front	Side	Front	Side	Front	Side	Front	Side	Front	Side	Front	Side	Front	Side	Front	Side	Front	Side			
12.0 m	kg																				*9750	*9750	11.82	
10.5 m	kg													*12 200	*12 200							*9400	*9400	12.87
9.0 m	kg											*13 700	*13 700	*12 900	12 100	*10 150	9600					*9250	*9250	13.67
7.5 m	kg											*14 400	*14 400	*13 300	11 800	12 300	9450					*9250	8450	14.27
6.0 m	kg							*20 250	*20 250	*17 250	*17 250	*15 250	14 250	*13 850	11 400	12 050	9250					*9400	7800	14.69
4.5 m	kg					*29 300	*29 300	*22 600	22 450	*18 750	17 150	*16 200	13 550	14 250	10 950	11 750	8950					*9650	7400	14.94
3.0 m	kg					*20 200	*20 200	*24 700	20 800	*20 100	16 100	16 850	12 850	13 750	10 450	11 400	8650	9600	7150			9550	7150	15.04
1.5 m	kg					*15 750	*15 750	*26 100	19 600	20 300	15 250	16 250	12 250	13 350	10 050	11 150	8350					9450	7000	14.99
Ground Line	kg					*17 000	*17 000	25 550	18 800	19 600	14 600	15 750	11 800	12 950	9700	10 900	8150					9500	7050	14.78
-1.5 m	kg			*11 350	*11 350	*20 750	*20 750	25 100	18 350	19 200	14 200	15 400	11 450	12 700	9450	10 750	8000					9800	7250	14.42
-3.0 m	kg	*12 300	*12 300	*16 800	*16 800	*26 150	25 550	24 900	18 200	18 950	14 000	15 200	11 250	12 600	9350	10 700	7950					10 300	7650	13.88
-4.5 m	kg	*17 900	*17 900	*23 000	*23 000	*29 200	25 750	*24 150	18 250	18 950	14 000	15 200	11 250	12 600	9350							11 200	8300	13.14
-6.0 m	kg	*24 100	*24 100	*30 400	*30 400	*26 050	*26 050	*21 850	18 500	*18 350	14 150	15 350	11 400	*12 400	9550							*12 000	9400	12.18
-7.5 m	kg			*25 300	*25 300	*21 700	*21 700	*18 450	*18 450	*15 400	14 550	*12 350	11 800									*11 350	11 250	10.91
-9.0 m	kg					*15 650	*15 650	*13 300	*13 300	*10 400	*10 400											*9800	*9800	9.24

Boom – 10.0 m

Coupler – N/A

Bucket – None

Stick – R5.5 m

Shoes – 650 mm double grouser

Load Point Height	kg	3.0 m		4.5 m		6.0 m		7.5 m		9.0 m		10.5 m		12.0 m		13.5 m		15.0 m		m				
		Front	Side	Front	Side	Front	Side	Front	Side	Front	Side	Front	Side	Front	Side	Front	Side	Front	Side	Front	Side			
12.0 m	kg																					*9750	*9750	11.82
10.5 m	kg													*12 200	12 150							*9400	*9400	12.87
9.0 m	kg											*13 700	*13 700	*12 900	12 000	*10 150	9500					*9250	9250	13.67
7.5 m	kg											*14 400	*14 400	*13 300	11 700	12 150	9350					*9250	8350	14.27
6.0 m	kg							*20 250	*20 250	*17 250	*17 250	*15 250	14 100	*13 850	11 300	11 900	9150					*9400	7750	14.69
4.5 m	kg					*29 300	*29 300	*22 600	22 200	*18 750	16 950	*16 200	13 400	14 100	10 800	11 600	8850					*9650	7300	14.94
3.0 m	kg					*20 200	*20 200	*24 700	20 600	*20 100	15 950	16 700	12 700	13 600	10 350	11 300	8550	9450	7100			9400	7050	15.04
1.5 m	kg					*15 750	*15 750	*26 100	19 350	20 100	15 100	16 050	12 100	13 200	9950	11 000	8250					9300	6950	14.99
Ground Line	kg					*17 000	*17 000	25 300	18 550	19 400	14 450	15 550	11 650	12 850	9600	10 750	8050					9400	6950	14.78
-1.5 m	kg			*11 350	*11 350	*20 750	*20 750	24 800	18 150	19 000	14 050	15 200	11 300	12 550	9350	10 600	7900					9650	7150	14.42
-3.0 m	kg	*12 300	*12 300	*16 800	*16 800	*26 150	25 250	24 650	18 000	18 750	13 850	15 050	11 150	12 450	9250	10 550	7850					10 200	7550	13.88
-4.5 m	kg	*17 900	*17 900	*23 000	*23 000	*29 200	25 500	*24 150	18 050	18 750	13 800	15 000	11 100	12 450	9250							11 050	8200	13.14
-6.0 m	kg	*24 100	*24 100	*30 400	*30 400	*26 050	25 900	*21 850	18 300	*18 350	14 000	15 150	11 250	*12 400	9450							*12 000	9300	12.18
-7.5 m	kg			*25 300	*25 300	*21 700	*21 700	*18 450	*18 450	*15 400	14 400	*12 350	11 650									*11 350	11 100	10.91
-9.0 m	kg					*15 650	*15 650	*13 300	*13 300	*10 400	*10 400											*9800	*9800	9.24

*Indicates that the load is limited by hydraulic lifting capacity rather than tipping load. The above loads are in compliance with hydraulic excavator lift capacity standard ISO 10567:2007. They do not exceed 87% of hydraulic lifting capacity or 75% of tipping load. Weight of all lifting accessories must be deducted from the above lifting capacities. Lifting capacities are based on the machine standing on a firm, uniform supporting surface.

Always refer to the appropriate Operation and Maintenance Manual for specific product information.

390D/390D L Hydraulic Excavator Specifications

390D Mass Boom Lift Capacities



Load Point Height



Load at Maximum Reach



Load Radius Over Front



Load Radius Over Side

Boom – 7.25 m

Coupler – N/A

Bucket – None

Stick – M3.4 m

Shoes – 750 mm double grouser

 Load Point Height kg	3.0 m		4.5 m		6.0 m		7.5 m		9.0 m		 m			
	 kg	 m	 kg	 m	 kg	 m	 kg	 m	 kg	 m	 kg	 m		
10.5 m												*17 400	*17 400	6.96
9.0 m								*21 650	*21 650			*15 900	*15 900	8.36
7.5 m								*23 500	*23 500	*18 950	18 650	*15 350	*15 350	9.32
6.0 m					*29 350	*29 350	*24 900	24 650	*22 200	18 300	*15 250	*15 250		9.95
4.5 m			*45 600	*45 600	*33 050	*33 050	*26 800	23 600	22 950	17 800	*15 600	14 250		10.33
3.0 m					*36 200	31 500	*28 500	22 600	22 350	17 200	*16 350	13 650		10.47
1.5 m					*37 700	30 200	28 700	21 750	21 800	16 700	*17 600	13 550		10.40
Ground Line			*27 950	*27 950	*37 150	29 500	28 150	21 250	21 450	16 400	18 200	14 000		10.10
-1.5 m		*23 550	*23 550	*41 700	*41 700	*34 700	29 350	*27 650	21 050	21 400	16 300	19 700	15 100	9.55
-3.0 m		*38 700	*38 700	*37 000	*37 000	*30 150	29 550	*24 000	21 200			*18 800	17 350	8.70
-4.5 m				*27 250	*27 250	*22 550	*22 550					*16 350	*16 350	7.46

Boom – 7.25 m

Coupler – N/A

Bucket – None

Stick – M3.4 m

Shoes – 650 mm double grouser

 Load Point Height kg	3.0 m		4.5 m		6.0 m		7.5 m		9.0 m		 m			
	 kg	 m	 kg	 m	 kg	 m	 kg	 m	 kg	 m	 kg	 m		
10.5 m												*17 400	*17 400	6.96
9.0 m								*21 650	*21 650			*15 900	*15 900	8.36
7.5 m								*23 500	*23 500	*18 950	18 500	*15 350	*15 350	9.32
6.0 m					*29 350	*29 350	*24 900	24 450	*22 200	18 150	*15 250	*15 250		9.95
4.5 m			*45 600	*45 600	*33 050	*33 050	*26 800	23 400	22 750	17 650	*15 600	14 100		10.33
3.0 m					*36 200	31 200	*28 500	22 400	22 150	17 050	*16 350	13 500		10.47
1.5 m					*37 700	29 900	28 450	21 550	21 600	16 550	17 450	13 400		10.40
Ground Line			*27 950	*27 950	*37 150	29 250	27 900	21 050	21 250	16 250	18 050	13 850		10.10
-1.5 m		*23 550	*23 550	*41 700	*41 700	*34 700	29 050	*27 650	20 850	21 200	16 150	19 500	14 950	9.55
-3.0 m		*38 700	*38 700	*37 000	*37 000	*30 150	29 300	*24 000	21 000			*18 800	17 150	8.70
-4.5 m				*27 250	*27 250	*22 550	*22 550					*16 350	*16 350	7.46

*Indicates that the load is limited by hydraulic lifting capacity rather than tipping load. The above loads are in compliance with hydraulic excavator lift capacity standard ISO 10567:2007. They do not exceed 87% of hydraulic lifting capacity or 75% of tipping load. Weight of all lifting accessories must be deducted from the above lifting capacities. Lifting capacities are based on the machine standing on a firm, uniform supporting surface.

Always refer to the appropriate Operation and Maintenance Manual for specific product information.

390D Mass Boom Lift Capacities



Load Point Height



Load at Maximum Reach



Load Radius Over Front



Load Radius Over Side















Boom – 7.25 m

Coupler – N/A

Bucket – None

Stick – M2.92 m

Shoes – 750 mm double grouser

		3.0 m		4.5 m		6.0 m		7.5 m		9.0 m				m
														
10.5 m	kg											*20 950	*20 950	6.27
9.0 m	kg							*22 600	*22 600			*18 950	*18 950	7.81
7.5 m	kg							*24 400	*24 400			*18 200	*18 200	8.82
6.0 m	kg			*39 800	*39 800	*30 550	*30 550	*25 700	24 200	*22 750	18 000	*18 100	16 400	9.49
4.5 m	kg					*34 100	32 650	*27 400	23 200	22 650	17 500	*18 550	15 050	9.89
3.0 m	kg					*36 800	30 850	*28 850	22 200	22 100	16 950	18 650	14 350	10.04
1.5 m	kg					*37 550	29 750	28 400	21 500	21 600	16 550	18 650	14 300	9.96
Ground Line	kg			*25 950	*25 950	*36 300	29 250	27 950	21 050	21 350	16 300	19 400	14 850	9.64
-1.5 m	kg			*40 350	*40 350	*33 250	29 250	*26 650	20 950	*20 650	16 350	*20 300	16 200	9.07
-3.0 m	kg			*33 300	*33 300	*27 950	*27 950	*22 050	21 250			*18 850	*18 850	8.17
-4.5 m	kg					*18 900	*18 900					*15 600	*15 600	6.77















Boom – 7.25 m

Coupler – N/A

Bucket – None

Stick – M2.92 m

Shoes – 650 mm double grouser

		3.0 m		4.5 m		6.0 m		7.5 m		9.0 m				m
														
10.5 m	kg											*20 950	*20 950	6.27
9.0 m	kg							*22 600	*22 600			*18 950	*18 950	7.81
7.5 m	kg							*24 400	*24 400			*18 200	*18 200	8.82
6.0 m	kg			*39 800	*39 800	*30 550	*30 550	*25 700	24 000	*22 750	17 800	*18 100	16 250	9.49
4.5 m	kg					*34 100	32 400	*27 400	23 000	22 450	17 350	*18 550	14 900	9.89
3.0 m	kg					*36 800	30 600	*28 850	22 000	21 850	16 800	18 500	14 250	10.04
1.5 m	kg					*37 550	29 450	28 150	21 250	21 400	16 350	18 450	14 150	9.96
Ground Line	kg			*25 950	*25 950	*36 300	29 000	27 700	20 850	21 150	16 150	19 200	14 700	9.64
-1.5 m	kg			*40 350	*40 350	*33 250	28 950	*26 650	20 750	*20 650	16 150	*20 300	16 000	9.07
-3.0 m	kg			*33 300	*33 300	*27 950	*27 950	*22 050	21 050			*18 850	18 800	8.17
-4.5 m	kg					*18 900	*18 900					*15 600	*15 600	6.77

*Indicates that the load is limited by hydraulic lifting capacity rather than tipping load. The above loads are in compliance with hydraulic excavator lift capacity standard ISO 10567:2007. They do not exceed 87% of hydraulic lifting capacity or 75% of tipping load. Weight of all lifting accessories must be deducted from the above lifting capacities. Lifting capacities are based on the machine standing on a firm, uniform supporting surface.

Always refer to the appropriate Operation and Maintenance Manual for specific product information.

390D/390D L Hydraulic Excavator Specifications

390D L Reach Boom Lift Capacities



Load Point Height



Load at Maximum Reach



Load Radius Over Front



Load Radius Over Side

Boom – 10.0 m
Stick – R5.5 m

Coupler – N/A
Shoes – 750 mm double grouser

Bucket – None

Load Point Height	3.0 m		4.5 m		6.0 m		7.5 m		9.0 m		10.5 m		12.0 m		13.5 m		15.0 m		m			
	Front	Side	Front	Side	Front	Side	Front	Side	Front	Side	Front	Side	Front	Side	Front	Side	Front	Side	Front	Side		
12.0 m	kg																		*9750	*9750	11.82	
10.5 m	kg												*12 200	*12 200					*9400	*9400	12.87	
9.0 m	kg										*13 700	*13 700	*12 900	12 350	*10 150	9800			*9250	*9250	13.67	
7.5 m	kg										*14 400	*14 400	*13 300	12 050	*12 500	9700			*9250	8650	14.27	
6.0 m	kg						*20 250	*20 250	*17 250	*17 250	*15 250	14 500	*13 850	11 650	*12 800	9450			*9400	8000	14.69	
4.5 m	kg					*29 300	*29 300	*22 600	*22 600	*18 750	17 500	*16 200	13 850	*14 450	11 200	*13 150	9150			*9650	7600	14.94
3.0 m	kg					*20 200	*20 200	*24 700	21 250	*20 100	16 450	*17 100	13 150	*15 000	10 700	*13 450	8850	*10 400	7350	*10 050	7300	15.04
1.5 m	kg					*15 750	*15 750	*26 100	20 000	*21 150	15 600	*17 850	12 550	*15 500	10 300	13 200	8600			*10 600	7200	14.99
Ground Line	kg					*17 000	*17 000	*26 700	19 200	*21 700	14 950	*18 250	12 050	15 400	9950	12 950	8350			11 300	7250	14.78
-1.5 m	kg			*11 350	*11 350	*20 750	*20 750	*26 550	18 800	*21 800	14 550	*18 350	11 750	15 150	9700	12 800	8200			11 650	7450	14.42
-3.0 m	kg	*12 300	*12 300	*16 800	*16 800	*26 150	26 150	*25 700	18 650	*21 300	14 350	*17 950	11 550	15 000	9600	12 750	8150			12 300	7850	13.88
-4.5 m	kg	*17 900	*17 900	*23 000	*23 000	*29 200	26 350	*24 150	18 700	*20 200	14 350	*17 050	11 550	*14 350	9600					*12 300	8550	13.14
-6.0 m	kg	*24 100	*24 100	*30 400	*30 400	*26 050	*26 050	*21 850	18 950	*18 350	14 500	*15 350	11 700	*12 400	9800					*12 000	9650	12.18
-7.5 m	kg			*25 300	*25 300	*21 700	*21 700	*18 450	*18 450	*15 400	14 900	*12 350	12 100							*11 350	*11 350	10.91
-9.0 m	kg					*15 650	*15 650	*13 300	*13 300	*10 400	*10 400									*9800	*9800	9.24

Boom – 10.0 m
Stick – R4.4 m

Coupler – N/A
Shoes – 750 mm double grouser

Bucket – None

Load Point Height	3.0 m		4.5 m		6.0 m		7.5 m		9.0 m		10.5 m		12.0 m		13.5 m		m					
	Front	Side	Front	Side	Front	Side	Front	Side	Front	Side	Front	Side	Front	Side	Front	Side	Front	Side				
12.0 m	kg											*12 950	*12 950						*12 950	*12 950	10.50	
10.5 m	kg											*14 550	*14 550						*12 450	*12 450	11.67	
9.0 m	kg											*14 850	*14 850	*13 950	11 850				*12 250	10 800	12.55	
7.5 m	kg								*17 250	*17 250	*15 450	14 600	*14 150	11 600					*12 250	9650	13.20	
6.0 m	kg					*28 250	*28 250	*22 100	*22 100	*18 500	17 800	*16 200	14 000	*14 600	11 250	*13 450	9100			*12 450	8900	13.66
4.5 m	kg							*24 250	21 700	*19 850	16 750	*17 000	13 350	*15 050	10 850	13 500	8900			*12 800	8400	13.93
3.0 m	kg							*25 900	20 250	*20 950	15 850	*17 750	12 750	*15 500	10 450	13 250	8650			12 450	8100	14.04
1.5 m	kg							*26 700	19 350	*21 650	15 150	*18 250	12 250	15 550	10 100	13 050	8450			12 350	7950	13.98
Ground Line	kg					*13 200	*13 200	*26 650	18 850	*21 850	14 650	*18 400	11 850	15 250	9800	12 900	8300			12 550	8050	13.76
-1.5 m	kg					*20 100	*20 100	*25 850	18 650	*21 500	14 400	*18 150	11 650	15 100	9650					13 000	8350	13.36
-3.0 m	kg			*17 950	*17 950	*28 350	26 450	*24 450	18 700	*20 600	14 350	*17 400	11 600	*14 700	9650					*13 200	8900	12.78
-4.5 m	kg			*26 800	*26 800	*26 100	*26 100	*22 350	18 900	*18 950	14 500	*15 950	11 700							*12 950	9850	11.98
-6.0 m	kg			*24 850	*24 850	*22 350	*22 350	*19 350	19 300	*16 400	14 800	*13 300	12 050							*12 350	11 500	10.90
-7.5 m	kg					*17 100	*17 100	*14 900	*14 900	*12 100	*12 100									*10 950	*10 950	9.47

*Indicates that the load is limited by hydraulic lifting capacity rather than tipping load. The above loads are in compliance with hydraulic excavator lift capacity standard ISO 10567:2007. They do not exceed 87% of hydraulic lifting capacity or 75% of tipping load. Weight of all lifting accessories must be deducted from the above lifting capacities. Lifting capacities are based on the machine standing on a firm, uniform supporting surface.

Always refer to the appropriate Operation and Maintenance Manual for specific product information.

390D L General Purpose Boom Lift Capacities



Load Point Height



Load at Maximum Reach



Load Radius Over Front



Load Radius Over Side

Boom – 8.4 m

Coupler – N/A

Bucket – None

Stick – R5.5 m

Shoes – 650 mm double grouser

Load Point Height	kg	3.0 m		4.5 m		6.0 m		7.5 m		9.0 m		10.5 m		12.0 m		13.5 m		m		
		Front	Side	Front	Side	Front	Side	Front	Side	Front	Side	Front	Side	Front	Side	Front	Side	Front	Side	
12.0 m	kg																	*9050	*9050	9.83
10.5 m	kg											*10 950	*10 950					*8500	*8500	11.07
9.0 m	kg											*13 000	*13 000					*8200	*8200	12.00
7.5 m	kg											*14 450	*14 450	*11 500	*11 500			*8050	*8050	12.68
6.0 m	kg									*17 550	*17 550	*16 200	15 150	*13 500	12 050			*8100	*8100	13.15
4.5 m	kg					*27 100	*27 100	*22 200	*22 200	*19 200	18 650	*17 150	14 650	*15 400	11 750			*8250	*8250	13.43
3.0 m	kg					*31 500	*31 500	*24 800	23 350	*20 800	17 800	*18 200	14 100	*16 300	11 400	*9000	*9000	*8600	*8600	13.54
1.5 m	kg					*34 800	30 650	*26 950	22 150	*22 200	17 050	*19 050	13 600	16 500	11 100			*9050	*9050	13.48
Ground Line	kg			*19 000	*19 000	*36 450	29 400	*28 300	21 300	*23 150	16 450	*19 650	13 150	16 250	10 850			*9750	9350	13.25
-1.5 m	kg	*14 250	*14 250	*23 200	*23 200	*36 600	28 750	*28 750	20 700	*23 500	16 000	19 500	12 900	16 050	10 650			*10 700	9700	12.84
-3.0 m	kg	*20 200	*20 200	*29 400	*29 400	*35 350	28 500	*28 150	20 450	*23 050	15 800	*19 250	12 750	*15 550	10 600			*12 200	10 350	12.23
-4.5 m	kg	*27 050	*27 050	*37 750	*37 750	*32 850	28 600	*26 400	20 450	*21 650	15 750	*17 700	12 750					*14 500	11 500	11.39
-6.0 m	kg	*35 550	*35 550	*35 950	*35 950	*28 700	*28 700	*23 250	20 700	*18 750	16 000							*14 900	13 500	10.26
-7.5 m	kg			*27 300	*27 300	*22 250	*22 250	*17 700	*17 700									*13 650	*13 650	8.71

Boom – 8.4 m

Coupler – N/A

Bucket – None

Stick – R4.4 m

Shoes – 650 mm double grouser

Load Point Height	kg	3.0 m		4.5 m		6.0 m		7.5 m		9.0 m		10.5 m		12.0 m		m		
		Front	Side	Front	Side	Front	Side	Front	Side	Front	Side	Front	Side	Front	Side	Front	Side	
10.5 m	kg									*15 350	*15 350					*11 350	*11 350	9.79
9.0 m	kg									*17 350	*17 350	*13 350	*13 350			*10 900	*10 900	10.82
7.5 m	kg									*18 050	*18 050	*16 900	15 000			*10 700	*10 700	11.57
6.0 m	kg							*21 900	*21 900	*19 250	18 800	*17 500	14 650	*11 750	11 650	*10 750	*10 750	12.09
4.5 m	kg					*30 450	*30 450	*24 300	23 750	*20 650	18 050	*18 250	14 200	*15 150	11 400	*11 050	10 800	12.40
3.0 m	kg					*34 200	31 100	*26 500	22 500	*22 000	17 250	*19 050	13 750	16 600	11 150	*11 500	10 400	12.52
1.5 m	kg					*36 300	29 600	*28 100	21 500	*23 050	16 600	*19 650	13 300	16 300	10 900	*12 200	10 300	12.46
Ground Line	kg					*36 650	28 800	*28 750	20 850	*23 500	16 150	19 600	13 000	16 150	10 750	*13 300	10 500	12.21
-1.5 m	kg			*24 000	*24 000	*35 650	28 500	*28 400	20 500	*23 300	15 850	19 400	12 800			*14 850	11 000	11.76
-3.0 m	kg	*23 450	*23 450	*33 350	*33 350	*33 350	28 550	*27 000	20 450	*22 200	15 800	*18 150	12 800			*16 500	11 950	11.09
-4.5 m	kg	*33 050	*33 050	*36 400	*36 400	*29 700	28 900	*24 300	20 650	*19 700	15 950					*16 150	13 650	10.15
-6.0 m	kg			*28 900	*28 900	*24 100	*24 100	*19 550	*19 550							*15 050	*15 050	8.85

*Indicates that the load is limited by hydraulic lifting capacity rather than tipping load. The above loads are in compliance with hydraulic excavator lift capacity standard ISO 10567:2007. They do not exceed 87% of hydraulic lifting capacity or 75% of tipping load. Weight of all lifting accessories must be deducted from the above lifting capacities. Lifting capacities are based on the machine standing on a firm, uniform supporting surface.

Always refer to the appropriate Operation and Maintenance Manual for specific product information.

390D/390D L Hydraulic Excavator Specifications

390D L General Purpose Boom Lift Capacities



Load Point Height



Load at Maximum Reach



Load Radius Over Front



Load Radius Over Side

















Boom – 8.4 m

Coupler – N/A

Bucket – None

Stick – GP2.92 m

Shoes – 750 mm double grouser

	3.0 m		4.5 m		6.0 m		7.5 m		9.0 m		10.5 m				m	
																
10.5 m	kg						*21 400	*21 400					*17 650	*17 650	8.15	
9.0 m	kg						*21 450	*21 450	*20 050	19 000			*16 450	*16 450	9.38	
7.5 m	kg						*22 700	*22 700	*20 300	18 750			*15 900	15 000	10.23	
6.0 m	kg					*30 550	*30 550	*24 600	24 050	*21 200	18 200	*19 150	14 200	*15 800	13 500	10.81
4.5 m	kg						*26 650	22 900	*22 300	17 550	*19 550	13 900	*16 050	12 600	11.16	
3.0 m	kg						*28 250	21 900	*23 200	16 950	*19 950	13 550	*16 650	12 150	11.29	
1.5 m	kg						*28 950	21 200	*23 700	16 450	19 950	13 250	*17 650	12 050	11.22	
Ground Line	kg					*30 450	29 050	*28 550	20 900	*23 500	16 200	*19 550	13 100	*18 300	12 400	10.95
-1.5 m	kg					*32 700	29 150	*27 150	20 800	*22 350	16 100		*18 000	13 250	10.44	
-3.0 m	kg			*32 750	*32 750	*29 200	*29 200	*24 450	21 000	*19 850	16 300		*17 300	14 900	9.68	
-4.5 m	kg			*26 750	*26 750	*23 950	*23 950	*19 850	*19 850				*15 750	*15 750	8.58	

*Indicates that the load is limited by hydraulic lifting capacity rather than tipping load. The above loads are in compliance with hydraulic excavator lift capacity standard ISO 10567:2007. They do not exceed 87% of hydraulic lifting capacity or 75% of tipping load. Weight of all lifting accessories must be deducted from the above lifting capacities. Lifting capacities are based on the machine standing on a firm, uniform supporting surface.

Always refer to the appropriate Operation and Maintenance Manual for specific product information.

390D L Mass Boom Lift Capacities



Load Point Height



Load at Maximum Reach



Load Radius Over Front



Load Radius Over Side















Boom – 7.25 m

Coupler – N/A

Bucket – None

Stick – M3.4 m

Shoes – 650 mm double grouser

	3.0 m		4.5 m		6.0 m		7.5 m		9.0 m				m	
														
10.5 m	kg											*17 400	*17 400	6.96
9.0 m	kg							*21 650	*21 650			*15 900	*15 900	8.36
7.5 m	kg							*23 500	*23 500	*18 950	18 850	*15 350	*15 350	9.32
6.0 m	kg					*29 350	*29 350	*24 900	24 850	*22 200	18 500	*15 250	*15 250	9.95
4.5 m	kg			*45 600	*45 600	*33 050	*33 050	*26 800	23 850	*23 000	17 950	*15 600	14 400	10.33
3.0 m	kg					*36 200	31 800	*28 500	22 800	*23 850	17 400	*16 350	13 800	10.47
1.5 m	kg					*37 700	30 500	*29 500	22 000	*24 250	16 900	*17 600	13 700	10.40
Ground Line	kg			*27 950	*27 950	*37 150	29 800	*29 300	21 450	*23 800	16 600	*19 550	14 150	10.10
-1.5 m	kg	*23 550	*23 550	*41 700	*41 700	*34 700	29 650	*27 650	21 300	*22 000	16 500	*19 800	15 250	9.55
-3.0 m	kg	*38 700	*38 700	*37 000	*37 000	*30 150	29 850	*24 000	21 450			*18 800	17 500	8.70
-4.5 m	kg			*27 250	*27 250	*22 550	*22 550					*16 350	*16 350	7.46















Boom – 7.25 m

Coupler – N/A

Bucket – None

Stick – M2.92 m

Shoes – 750 mm double grouser

	3.0 m		4.5 m		6.0 m		7.5 m		9.0 m				m	
														
10.5 m	kg											*20 950	*20 950	6.27
9.0 m	kg							*22 600	*22 600			*18 950	*18 950	7.81
7.5 m	kg							*24 400	*24 400			*18 200	*18 200	8.82
6.0 m	kg			*39 800	*39 800	*30 550	*30 550	*25 700	24 650	*22 750	18 350	*18 100	16 700	9.49
4.5 m	kg					*34 100	33 250	*27 400	23 650	*23 400	17 850	*18 550	15 350	9.89
3.0 m	kg					*36 800	31 450	*28 850	22 650	*24 000	17 300	*19 500	14 700	10.04
1.5 m	kg					*37 550	30 350	*29 450	21 900	*24 150	16 900	*21 150	14 600	9.96
Ground Line	kg			*25 950	*25 950	*36 300	29 850	*28 850	21 500	*23 300	16 650	*20 950	15 150	9.64
-1.5 m	kg			*40 350	*40 350	*33 250	29 850	*26 650	21 400	*20 650	16 700	*20 300	16 550	9.07
-3.0 m	kg			*33 300	*33 300	*27 950	*27 950	*22 050	21 700			*18 850	*18 850	8.17
-4.5 m	kg					*18 900	*18 900					*15 600	*15 600	6.77

*Indicates that the load is limited by hydraulic lifting capacity rather than tipping load. The above loads are in compliance with hydraulic excavator lift capacity standard ISO 10567:2007. They do not exceed 87% of hydraulic lifting capacity or 75% of tipping load. Weight of all lifting accessories must be deducted from the above lifting capacities. Lifting capacities are based on the machine standing on a firm, uniform supporting surface.

Always refer to the appropriate Operation and Maintenance Manual for specific product information.

390D/390D L Hydraulic Excavator Specifications

390D L Mass Boom Lift Capacities



Load Point Height



Load at Maximum Reach



Load Radius Over Front



Load Radius Over Side

Boom – 7.25 m

Coupler – N/A

Bucket – None

Stick – M2.92 m

Shoes – 650 mm double grouser

 Load Point Height	3.0 m		4.5 m		6.0 m		7.5 m		9.0 m		 Load Radius Over Side		m	
	 kg	 kg	 kg	 kg	 kg	 kg	 kg	 kg	 kg	 kg	 kg	 kg		
10.5 m	kg											*20 950	*20 950	6.27
9.0 m	kg							*22 600	*22 600			*18 950	*18 950	7.81
7.5 m	kg							*24 400	*24 400			*18 200	*18 200	8.82
6.0 m	kg			*39 800	*39 800	*30 550	*30 550	*25 700	24 450	*22 750	18 150	*18 100	16 550	9.49
4.5 m	kg					*34 100	32 950	*27 400	23 400	*23 400	17 650	*18 550	15 200	9.89
3.0 m	kg					*36 800	31 150	*28 850	22 450	*24 000	17 150	*19 500	14 500	10.04
1.5 m	kg					*37 550	30 050	*29 450	21 700	*24 150	16 700	*21 150	14 450	9.96
Ground Line	kg			*25 950	*25 950	*36 300	29 550	*28 850	21 300	*23 300	16 450	*20 950	15 000	9.64
-1.5 m	kg			*40 350	*40 350	*33 250	29 550	*26 650	21 200	*20 650	16 500	*20 300	16 350	9.07
-3.0 m	kg			*33 300	*33 300	*27 950	*27 950	*22 050	21 500			*18 850	*18 850	8.17
-4.5 m	kg					*18 900	*18 900					*15 600	*15 600	6.77

*Indicates that the load is limited by hydraulic lifting capacity rather than tipping load. The above loads are in compliance with hydraulic excavator lift capacity standard ISO 10567:2007. They do not exceed 87% of hydraulic lifting capacity or 75% of tipping load. Weight of all lifting accessories must be deducted from the above lifting capacities. Lifting capacities are based on the machine standing on a firm, uniform supporting surface.

Always refer to the appropriate Operation and Maintenance Manual for specific product information.

390D L Bucket Specifications and Compatibility

	Linkage	Width	Capacity	Weight	Fill	Reach Boom		General Purpose Boom			ME Boom	
		mm	m ³	kg	%	R4.4HB2	R5.5HB2	R4.4HB2	R5.5HB2	G2.9JC	M2.9JC	M3.4JC
Without Quick Coupler												
General Duty (GD)	HB2	1350	3.0	3406	100%	○	⊗	●	⊙	–	–	–
	HB2	1650	3.9	3794	100%	⊗	⊗	⊙	○	–	–	–
	HB2	1900	4.6	4155	100%	⊗	⊗	○	⊗	–	–	–
	HB2	1100	2.2	2856	100%	●	⊙	●	●	–	–	–
	HB2	1350	2.9	3187	100%	○	⊗	●	●	–	–	–
	HB2	1650	3.7	3650	100%	⊗	⊗	●	○	–	–	–
	HB2	1900	4.3	3923	100%	⊗	⊗	○	⊗	–	–	–
	HB2	2000	4.6	4032	100%	⊗	⊗	○	⊗	–	–	–
	JC	2300	5.7	5822	100%	–	–	–	–	⊗	⊙	⊙
	JC	2420	6.0	6004	100%	–	–	–	–	⊗	⊙	○
JC	2575	6.5	6238	100%	–	–	–	–	⊗	○	◇	
General Duty XL (GDXL)	HB2	2000	5.3	4400	100%	⊗	⊗	⊗	⊗	–	–	–
	HB2	2250	6.0	4796	100%	⊗	⊗	⊗	⊗	–	–	–
Heavy Duty (HD)	JC	1750	4.1	4799	100%	–	–	–	–	●	●	●
	JC	2090	5.1	5441	100%	–	–	–	–	⊗	●	⊙
	JC	2300	5.7	5892	100%	–	–	–	–	⊗	⊙	⊙
Severe Duty (SD)	HB2	1100	2.3	3282	90%	●	○	●	●	–	–	–
	HB2	1350	3.0	3736	90%	○	⊗	●	●	–	–	–
	HB2	1650	3.9	4163	90%	⊗	⊗	⊙	○	–	–	–
	HB2	1900	4.6	4553	90%	⊗	⊗	○	⊗	–	–	–
	JC	1960	4.6	6229	90%	–	–	–	–	○	●	●
	JC	2240	5.4	6809	90%	–	–	–	–	⊗	●	⊙
	JC	2350	5.7	7015	90%	–	–	–	–	⊗	⊙	○
	JC	2440	6.0	7342	90%	–	–	–	–	⊗	⊙	○
Extreme Duty (XD)	JC	2090	5.0	6557	90%	–	–	–	–	○	●	⊙
	JC	2240	5.4	7733	90%	–	–	–	–	⊗	⊙	○
	JC	2350	5.7	7968	90%	–	–	–	–	⊗	⊙	○
Maximum dynamic load pin-on (payload + bucket)					kg	7200	6040	10 030	8500	11 960	15 320	14 100
With Quick Coupler (CW-70)												
Severe Duty (SD)	JC	2240	5.4	6559	90%	–	–	–	–	⊗	⊙	○
	JC	2350	5.7	6765	90%	–	–	–	–	⊗	⊙	⊗
Maximum dynamic load with CW coupler (payload + bucket)					kg	5780	4620	8610	7080	10 540	13 900	12 680

The above figures are based on maximum recommended dynamic working weights with front linkage fully extended at ground line with bucket curled. They do not exceed a stability ratio of 1.25.

Capacity based on ISO 7451.

Bucket weights include HD Long tips.

Maximum Material Density:

- 1800 kg/m³ or greater
- ⊙ 1500 kg/m³ or less
- 1200 kg/m³ or less
- ◇ 1200 kg/m³ or less, recommended for GD application only
- ⊗ Not Recommended

Caterpillar recommends using appropriate work tools to maximize the value customers receive from our products. Use of work tools, including buckets, which are outside of Caterpillar's recommendations or specifications for weight, dimensions, flows, pressures, etc. may result in less-than-optimal performance, including but not limited to reductions in production, stability, reliability, and component durability. Improper use of a work tool resulting in sweeping, prying, twisting and/or catching of heavy loads will reduce the life of the boom and stick.

390D/390D L Hydraulic Excavator Specifications

390D Bucket Specifications and Compatibility

	Linkage	Width	Capacity	Weight	Fill	Reach Boom		General Purpose Boom			ME Boom	
		mm	m ³	kg	%	R4.4HB2	R5.5HB2	R4.4HB2	R5.5HB2	G2.9JC	M2.9JC	M3.4JC
Without Quick Coupler												
General Duty (GD)	HB2	1350	3.0	3406	100%	○	⊗	●	⊙	–	–	–
	HB2	1650	3.9	3794	100%	⊗	⊗	⊙	○	–	–	–
	HB2	1900	4.6	4155	100%	⊗	⊗	○	⊗	–	–	–
	HB2	1100	2.2	2856	100%	●	⊙	●	●	–	–	–
	HB2	1350	2.9	3187	100%	○	⊗	●	●	–	–	–
	HB2	1650	3.7	3650	100%	⊗	⊗	●	○	–	–	–
	HB2	1900	4.3	3923	100%	⊗	⊗	○	⊗	–	–	–
	HB2	2000	4.6	4032	100%	⊗	⊗	○	⊗	–	–	–
	JC	2300	5.7	5822	100%	–	–	–	–	⊗	⊙	⊙
	JC	2420	6.0	6004	100%	–	–	–	–	⊗	⊙	○
JC	2575	6.5	6238	100%	–	–	–	–	⊗	○	○	
General Duty XL (GDXL)	HB2	2000	5.3	4400	100%	⊗	⊗	⊗	⊗	–	–	–
	HB2	2250	6.0	4796	100%	⊗	⊗	⊗	⊗	–	–	–
Heavy Duty (HD)	JC	1750	4.1	4799	100%	–	–	–	–	●	●	●
	JC	2090	5.1	5441	100%	–	–	–	–	○	●	⊙
	JC	2300	5.7	5892	100%	–	–	–	–	⊗	⊙	⊙
Severe Duty (SD)	HB2	1100	2.3	3282	90%	●	○	●	●	–	–	–
	HB2	1350	3.0	3736	90%	○	⊗	●	●	–	–	–
	HB2	1650	3.9	4163	90%	⊗	⊗	⊙	○	–	–	–
	HB2	1900	4.6	4553	90%	⊗	⊗	○	⊗	–	–	–
	JC	1960	4.6	6229	90%	–	–	–	–	○	●	●
	JC	2240	5.4	6809	90%	–	–	–	–	⊗	●	⊙
	JC	2350	5.7	7015	90%	–	–	–	–	⊗	⊙	○
	JC	2440	6.0	7342	90%	–	–	–	–	⊗	⊙	○
Extreme Duty (XD)	JC	2090	5.0	6557	90%	–	–	–	–	○	●	⊙
	JC	2240	5.4	7733	90%	–	–	–	–	⊗	⊙	○
	JC	2350	5.7	7968	90%	–	–	–	–	⊗	⊙	○
Maximum dynamic load pin-on (payload + bucket)					kg	7200	6040	10 030	8500	11 960	15 320	14 100
With Quick Coupler (CW-70)												
Severe Duty (SD)	JC	2240	5.4	6559	90%	–	–	–	–	⊗	⊙	○
	JC	2350	5.7	6765	90%	–	–	–	–	⊗	⊙	⊗
Maximum dynamic load with CW coupler (payload + bucket)					kg	5780	4620	8610	7080	10 540	13 900	12 680

Maximum Material Density:

- 1800 kg/m³ or greater
- ⊙ 1500 kg/m³ or less
- 1200 kg/m³ or less
- ⊗ Not Recommended

The above figures are based on maximum recommended dynamic working weights with front linkage fully extended at ground line with bucket curled. They do not exceed a stability ratio of 1.25.

Capacity based on ISO 7451.

Bucket weights include HD Long tips.

Caterpillar recommends using appropriate work tools to maximize the value customers receive from our products. Use of work tools, including buckets, which are outside of Caterpillar's recommendations or specifications for weight, dimensions, flows, pressures, etc. may result in less-than-optimal performance, including but not limited to reductions in production, stability, reliability, and component durability. Improper use of a work tool resulting in sweeping, prying, twisting and/or catching of heavy loads will reduce the life of the boom and stick.

Work Tool Offering Guide*

Boom Type	Reach Boom		General Purpose Boom			Mass Boom	
Stick Size	R5.5 m	R4.4 m	R5.5 m	R4.4 m	GP2.92 m	M3.4 m	M2.92 m
Multi-Processor		MP40**	MP40**	MP40			
Mobile Scrap and Demolition Shear				S365C**	S385C	S385C	S385C

*Offerings not available in all areas. Matches are dependent on excavator configurations. Consult your Cat dealer to determine what is offered in your area, and, for proper work tool match.

**Pin-on only.

390D/390D L Standard Equipment

Standard equipment may vary. Consult your Cat dealer for details.

ELECTRICAL

Alternator – 75 amp
Lights: Cab interior
Signal/warning horn
Power supply at battery compartment – 24V

ENGINE/POWER TRAIN

Automatic engine speed control
Automatic swing parking brake
Automatic travel parking brakes
Cat® C18 engine with ACERT™ Technology
Altitude capability to 2300 m
without derating
High ambient cooling, 52° C capability
Side-by-side cooling system
with separately mounted AC condenser
and variable speed fan
Two speed travel
Water separator
with level indicator for fuel line
Electric fuel priming pump

GUARDS

Heavy-duty travel motor guards
on upper frame
Heavy-duty swivel guard on undercarriage
Heavy-duty travel motor guards
on undercarriage

OPERATOR STATION

Air conditioner, heater and defroster
with automatic climate control
Ashtray and 24V lighter
Beverage/cup holder
Coat hook
Console-mounted, electronic-type joysticks
with adjustable gain and response
Floor mat
Instrument panel and gauges
with full color graphical display
Literature compartment
Neutral lever (lock-out) for all controls
Positive filtered ventilation
Pressurized cab
Retractable seat belt, 75 mm wide
Stationary skylight (polycarbonate)
Sunshade for windshield and skylight
Travel control pedals
with removable hand levers
Windshield wipers and washers
(upper and lower)

UNDERCARRIAGE

Grease lubricated and positive pin
retention track
Hydraulic track adjusters
Variable gauge
Steps, four

OTHER STANDARD EQUIPMENT

Auxiliary hydraulic valve
for hydro-mechanical tools
Cat® one key security system
with locks for doors, cab and fuel cap
Catwalks, left and right sides
Crossroller-type swing bearing
Drive for auxiliary pump
Mirrors, left and right
S·O·SSM quick sampling valves
for engine oil and hydraulic oil
Steel firewall between engine
and hydraulic pumps
Wiring provisions for Cat® Product Link,
AutoLube System and lighted beacon

Optional equipment may vary. Consult your Cat dealer for details.

FRONT LINKAGE

- Bucket linkages
- VB family for VB sticks
(available with or without lifting eye)
- WB family for WB sticks
(available with or without lifting eye)
- Buckets – see charts
- Booms (with two working lights)
 - Mass Excavation – 7250 mm
 - Reach – 10 000 mm
 - GP – 8400 mm
- Sticks
 - For Mass Boom
 - M2.92JC
 - M3.4JC
 - For Reach Boom
 - R5.5HB2
 - R4.4HB2
 - For GP Boom
 - R5.5HB2
 - R4.4HB2
 - GP2.92JC
- Tips, sidecutters and edge protectors

TRACK

- Double grouser, heavy duty
 - 650 mm
 - 750 mm
 - 900 mm

GUARDS

- FOGS (Falling Object Guard System)
including overhead and windshield guards
- Track guiding guards
 - Full length
 - Center section
 - Three pieces
- Wire mesh screen for windshield
- Auxiliary controls and lines
 - Auxiliary boom lines
(high pressure for reach and mass booms)
 - Auxiliary stick lines
(high pressure for reach and mass booms)
- Basic control arrangements:
 - Single action – one way, high-pressure circuit for hammer application
 - Combined function – one way, high-pressure circuit for hammer application function for one-way or two-way high pressure

MISCELLANEOUS OPTIONS

- Boom lowering control device
- Cab front rain protector
- Converter, 10 amp 12V (one)
- Electric refueling pump
- Fine filtration filter
- Jump start terminals
- Reversible cooling fan
including protective screen
- Starting aid with ether for cold weather
- Stick lowering control device
- Travel alarm with cut-off switch

OPERATOR COMPARTMENT

- Joysticks
 - Four button joystick
for standard machine or single action auxiliary control
 - Thumb wheel modulation joystick
for use with combined auxiliary control
- Lunch box storage with lid
- Machine Security System
with programmable keys
- Radio
 - AM/FM radio-mounted in right console
with antenna and two speakers
 - Radio-ready mounting at rear location
including 24V to 12V converter,
speakers, antenna
- Seat
 - Adjustable, high back
with mechanical suspension
 - Adjustable, high back
with air suspension
 - Adjustable, high back heated
with air suspension
- Straight travel pedal
- Windshield
 - One-piece, standard duty
 - 70-30 split, sliding

390D/390D L Hydraulic Excavator

For more complete information on Cat products, dealer services, and industry solutions, visit us on the web at www.cat.com

© 2013 Caterpillar Inc.
All rights reserved

Materials and specifications are subject to change without notice. Featured machines in photos may include additional equipment. See your Cat dealer for available options.

CAT, CATERPILLAR, SAFETY.CAT.COM, their respective logos, "Caterpillar Yellow" and the "Power Edge" trade dress, as well as corporate and product identity used herein, are trademarks of Caterpillar and may not be used without permission.

AEHQ6140-02 (01-2013)
Replaces AEHQ6140-01
(APD)

