

B30D 6x6

**ARTICULATED
DUMP TRUCK
Mk VII**



Blu@dvantage™

- Gross Power: 240 kW (322 hp)
- Gross Torque: 1 250 Nm (922 lbft)
- Rated Payload: 27 300 kg (60,186 lbs)

BELL

B30D 6x6 ARTICULATED DUMP TRUCK MKVII

ENGINE

Mercedes Benz inline 6 cylinder, turbocharged, intercooled, low emission diesel engine

Gross power 240 kW (322 hp) @ 2,200 -1,600 rpm

Net Power 232 kW (311 hp) @ 2,200 -1,600 rpm

Torque 1,250 Nm (922 lbf) @ 1,200 - 1,600 rpm

Displacement 7,2 litres (439 cu.in)

Fuel tank capacity 310 l (85 US gal)

Auxiliary Brake Exhaust brake
Engine Valve Brake (EVB)

AdBlue Tank Capacity 31 l (8.2 US gal)

Certification OM 926 LA meets Europe (EU) stage 3b emissions regulations

TRANSMISSION

Fully automatic ZF planetary transmission

Layout Engine mounted

Gear Layout Constant meshing planetary gears, clutch operated

Gears 6 Forward, 1 Reverse

Clutch type Hydraulically operated multi-disc

Control type Electronic

Torque Converter Hydrodynamic with lock-up in all gears

TRANSFER BOX

Remote mounted

Manufacturer Bell

Model 13100

Layout Three in-line helical gears.

Output Differential 67/33 torque proportioning, Pneumatically lockable on the move.

AXLES

High strength steel fabricated with spiral bevel type gears on the limited slip locking differential and heavy duty outboard planetary gears.

Model Bell 18T

BRAKING SYSTEM

SERVICE BRAKE

Dual circuit, full hydraulic actuation caliper brakes on all wheels or wet disc brakes option

Maximum brake force PARK & EMERGENCY

164 kN (36,900 lbf)
Spring applied, air released driveline mounted disc.



Maximum brake force AUXILIARY BRAKE

396 kN (89,000 lbf)
Automatic exhaust brake and Engine Valve Brake (EVB) Variable Adjustable Hydraulic retarder in transmission

Maximum retardation

442 kW (593 hp)

WHEELS

Tyre Earthmover 23.5R25 or 750/65R25

FRONT SUSPENSION

Semi-independent, quad rubber mounted leading arm linkages supported by nitrogen and oil filled struts.

REAR SUSPENSION

Pivoting walking beams, distributing equal load through laminated rubber suspension blocks. Each axle is coupled to the chassis by four rubber-bushed links for ideal vertical movement.

HYDRAULIC SYSTEM

Variable displacement with load sensing system incorporating a ground driven emergency steering pump.

Flow 184 l/min (48.6 gal/min)

Pressure 25 Mpa (3,915 psi)

Filter 5 microns

STEERING SYSTEM

Hydrostatically actuated, low effort, fast acting. Two double-acting steering cylinders

Lock to lock turns 4.1

Steering Angle 45°

DUMPING SYSTEM

Two double-acting, single stage, dump cylinders

Raise Time 12 s

Lowering Time 6 s

Tipping Angle 70°

PNEUMATIC SYSTEM

Air drier with heater and integral unloader valve, serving park brake and auxiliary functions

System Pressure 810 kPa (123 psi)

ELECTRICAL SYSTEM

Voltage 24 V

Battery Type Two maintenance free permanently sealed

Battery Capacity 2 X 105 Ah

Alternator Rating 28 V 80 A

VEHICLE SPEEDS

1st	8 km/h
2nd	13 km/h
3rd	22 km/h
4th	31 km/h
5th	44 km/h
6th	53 km/h
R	8 km/h



B30D 6x6 ARTICULATED DUMP TRUCK MkVII

LOAD CAPACITY & GROUND PRESSURE

WEIGHTS		GROUND PRESSURE			LOAD CAPACITY			OPTION WEIGHTS	
UNLADEN	kg	LADEN (No sinkage)	kPa	kPa	BODY	m³	cu.yd		kg
Front	9,710		23.5R25	750/65R25	Struck Capacity	13	17	Bin liner	1,192
Middle	4,490	Front	265	234	SAE 2:1 Capacity	17	22,2	Tailgate	708
Rear	4,490	Middle	330	277	SAE 1:1 Capacity	20,5	26,8	Extra wheelset	536
Total	18,690	Rear	330	277	SAE 2:1 Capacity with Autogate	17,5	22,9		
LADEN									
Front	13,350	LADEN (With sinkage)							
Middle	16,320	Front	138	115	Rated Payload	27 300 kg (60,186 lbs)			
Rear	16,320	Middle	165	137					
Total	45,990	Rear	165	137					

GRADEABILITY/RIMPULL

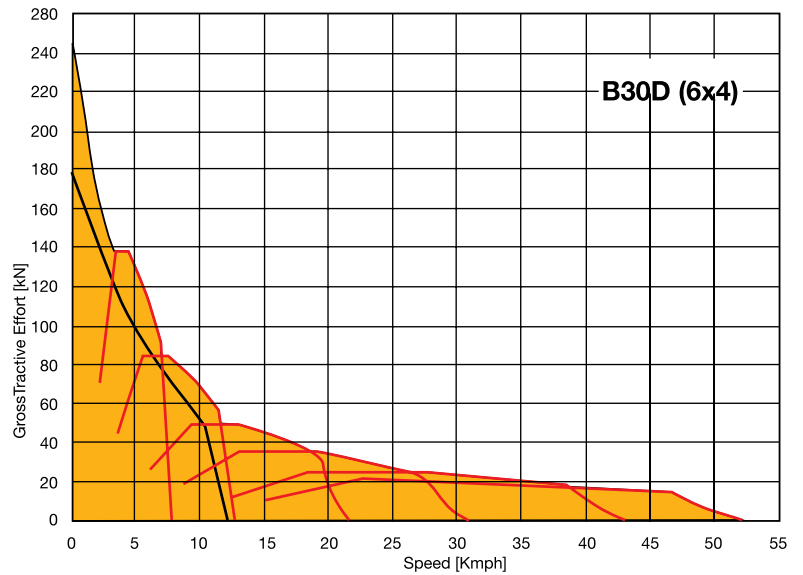
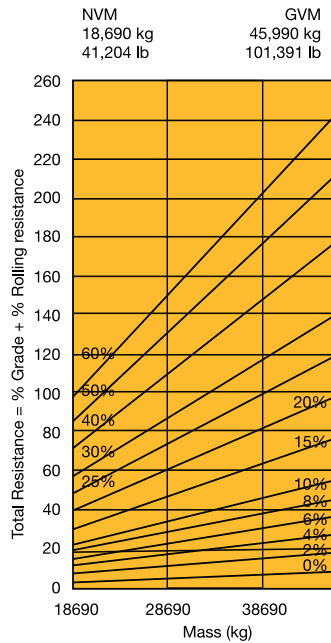

RETARDATION

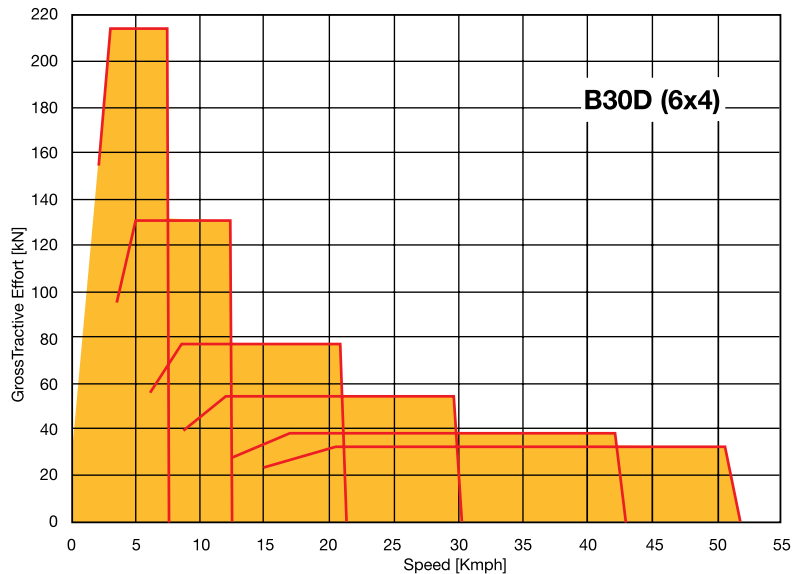
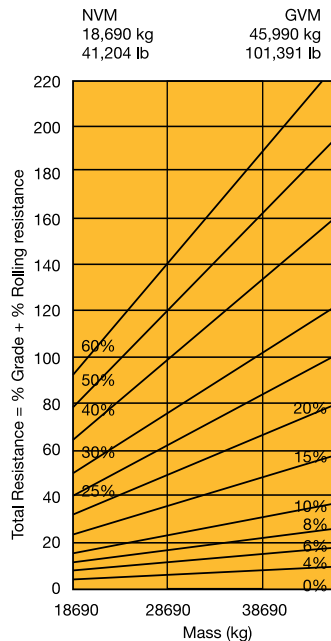

B30D 6x6 ARTICULATED DUMP TRUCK Mk VII

DIMENSIONS

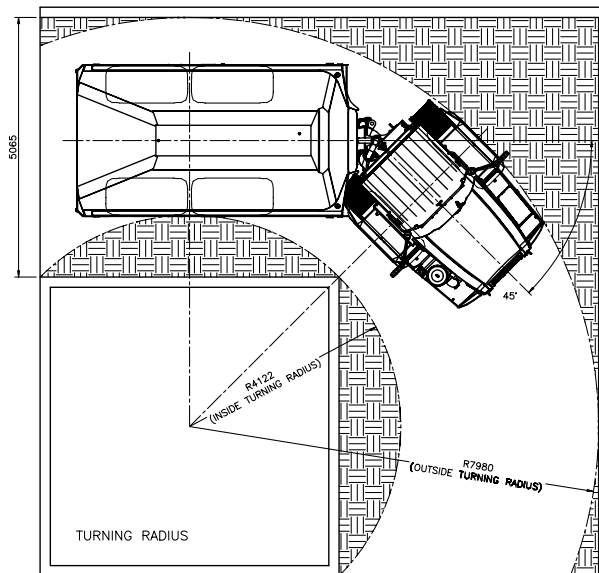
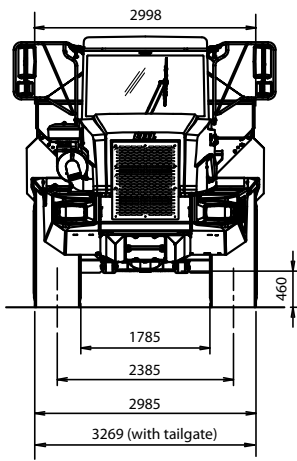
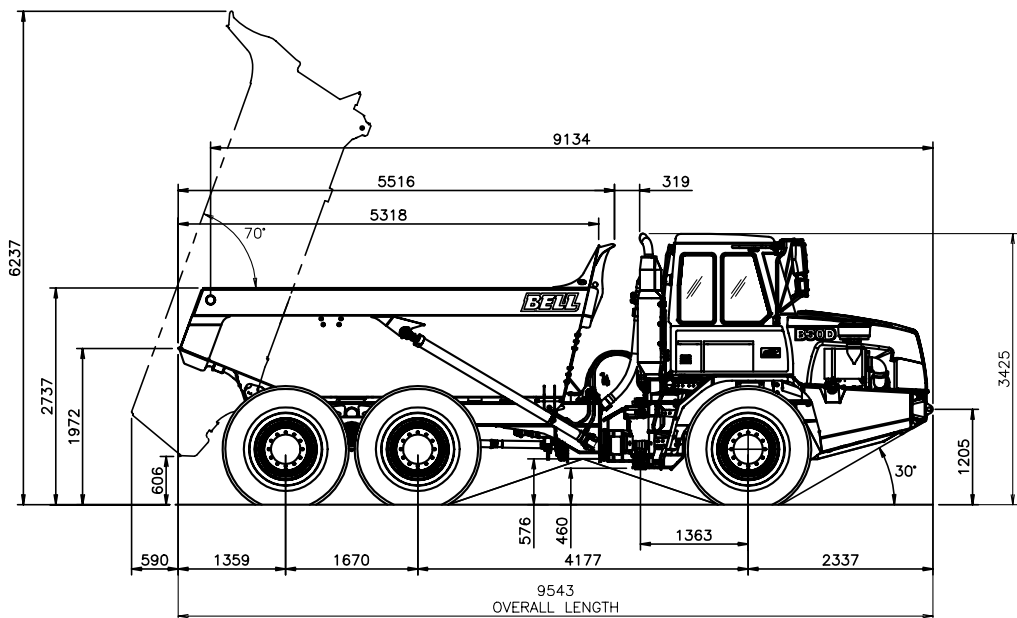

B30D 6x6 ARTICULATED DUMP TRUCK MKVII

AVAILABLE EQUIPMENT*

Cab

- ROPS/FOPS certification
- Protective rear window guard
- Tilt cab for service access
- Gas strut supported door
- Tinted safety glass
- Sliding windows
- Rear view mirrors- regular and wide angle
- Electrically adjustable rearview mirrors - one per side
- Sun visor
- Wiper/washer with intermittent control
- Tilt and telescoping steering wheel
- Adjustable, air suspension seat with retractable seat belt
- Fold-away trainer seat with retractable seat belt
- HVAC climate control system with filtered and ducted air
- Rotating beacon
- 12 V power outlet/12 V cigarette lighter
- Ash tray
- Drinks holder
- Cooled/heated lunch box
- I-Tip programmable bin tip
- Sound insulated to 76 dB(A) to ISO 6396
- Radio/CD/Tape
- Memory Module
- Air horn

MDU Features

- Operator / Site selected speed control
- Tipping counter
- Trip timer
- Trip distance
- On Board Weigh System (OBW)
- Transmission gear selection
- Fuel Consumption
- Diagnostics
- Intermittent wiper timing control
- Speedo calibration for alternative tyre sizes
- Metric /Imperial unit selection
- Warning lights with audible buzzer

Gauges

- Engine coolant temperature
- Engine oil pressure
- Transmission oil temperature
- Fuel
- Tachometer
- Battery voltage
- Hourmeter
- Odometer
- System air pressure

Vehicle

- Ground driven emergency steering
- Bin safety prop
- Articulation lock
- Integral transmission output retarder with 6 settings

Other

- (Factory or field installed)
- Groeneveld auto greasing system
- Retractable sun visor
- Exhaust body heating
- Autogate
- Body liners
- Fleetmatic Satellite Monitoring System
- Driver ID and immobiliser
- Forward working lights
- Artic reverse light
- Fuel heater
- External windshield visor
- Headlight protection grills
- Rear window wiper
- Antenna mounting bracket
- System for reverse camera
- Wiggins quick fuelling system
- Tyre pressure monitoring

*standard specification for machines may vary according to region



B30D 6x6 ARTICULATED DUMP TRUCK Mk VII

- The exclusive on-board weighing option presents the operator with real time information on the payload while the machine is being loaded. A 'limp home' mode can also be activated if the machine is significantly over-loaded.

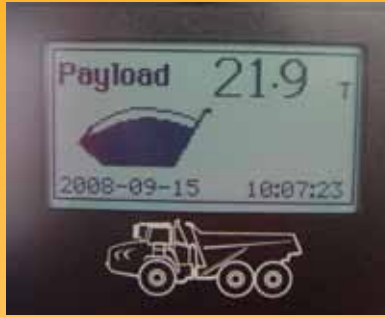

- The park brake automatically applies when neutral is selected and it is not possible to engage neutral at speed. Torque dependent park brake release (hill assist) ensures no roll back on slopes.



- The incorporation of a Pitch and Roll sensor in the vehicle allows the bin to not be operated if the truck is in an unsafe position.



- Full hand-rails kit can be installed to provide even more safety when performing engine checks.



- Keyless start, driver identity, and access codes ensures no unauthorized operation of your equipment.



- Both operator or site selectable maximum speed control allows the vehicle to automatically decelerate and apply the retarder to prevent onsite speeding.



- Reverse cameras are available for factory or on site fitment ensuring full view when reversing.



- Optional Tyre pressure - monitoring System ensures that the operator has real time information on all tyres pressure and temperature conditions.

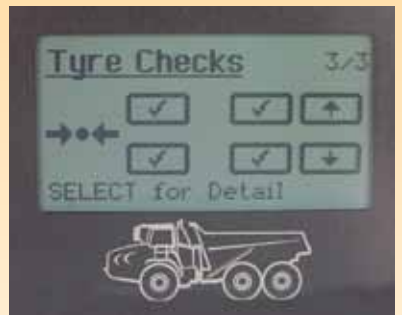



- The best in class retarder and engine braking automatically applies when the operator lifts his foot off the accelerator. Retarder aggressiveness can be simply adjusted on the sealed switch module ensuring maximum descent control for all conditions.

- All trucks can be set up to automatically sound the horn when starting or switching between forward and reverse.

BELL INTERNATIONAL: Tel: +27 (0) 35-907 9431

 Tel: +33 (0) 5 55 89 23 56

 Tel: +49 (0) 6631 / 91 13 - 0

 Tel: +34 91 879 60 19

 Tel: +27 (0) 11-928-9700

 Tel: +44 (0) 1283 712862

 Tel: +7 495 647 20 90

E-mail: sales@bellequipment.com

• www.bellequipment.com

All dimensions are shown in millimetres, unless otherwise stated between brackets.
Under our policy of continuous improvement, we reserve the right to change specifications and design without prior notice. Photographs featured in this brochure may include optional equipment.

**Strong Reliable Machines
Strong Reliable Support**

BELL