

SAMSUNG

HEAVY INDUSTRIES



# SE280(N)LC-2

**Samsung Crawler Excavator**

<b>Flywheel Horsepower:</b>	<b>132.5 kw</b>	<b>178 hp</b>
<b>Operating Weight:</b>	<b>28,500 kg</b>	<b>62,830 lb</b>
<b>Bucket Capacity (SAE):</b>	<b>0.85 - 2.05 m<sup>3</sup></b>	<b>1.11 - 2.7 yd<sup>3</sup></b>



# Samsung Excavators Provide Outstanding Power and Precision



Crawler Excavators from Samsung provide more power performance and durability than ever before. We've made refinements in the hydraulic system to provide more power and speed, making fine control easier.

At the same time, we've reinforced the steel in the boom, the track frames and the undercarriage to provide longer life in the toughest of applications.

Your operators will also appreciate the comfort and safety features offered in our unique hi-visibility cab. All in all, this machine offers you the best value on the market today.



HEAVY INDUSTRIES



# Modern Technology

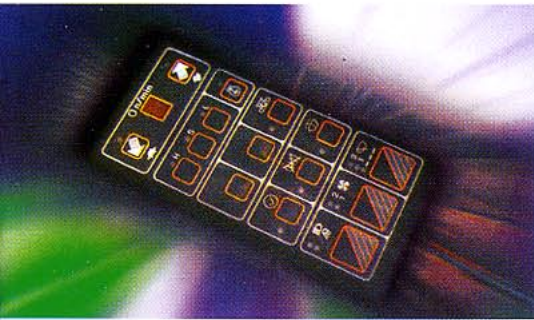

By utilising the latest electro-mechanical technology, Samsung can provide the optimum balance, precision and power whilst offering the highest degree of efficiency and economy.

- **Mode Selection System** - Samsung's three mode system makes it possible to select the speed and power to fit job conditions. This feature results in higher productivity and reduced fuel consumption.

**H Mode (Heavy Duty)** - This high capacity mode provides the hydraulic pumps with 100% of engine power when working hard ground, rock or other difficult applications.

**S Mode (Medium Duty)** - A standard mode that balances engine power and fuel costs for general excavating and loading work.

**L Mode (Light Duty)** - An economical mode requiring less engine power for use in light loading, standby or precision work.

# Maximum Productivity

Samsung's Crawler Excavators match engine power with hydraulic output to provide the right combination of speed and power in any application.

- **High Capacity Cummins Engine** - The Cummins engines are renowned worldwide for their capacity and durability. Its excellent combustion efficiency results in an economical, powerful engine that proves itself in severe weather conditions. Fuel costs are minimal and parts and service support are readily available.

- **"Exceptional" Working Range** - The reach, dig depth and dump height capabilities of Samsung Excavators are among the highest in their size class. You can handle more work with less manoeuvring.

- **Lower Frame Durability** - The high stress areas of the Lower Frame are reinforced to handle the harshest ground conditions.

- **Outstanding Digging Performance** - High breakout forces provide more than enough power to handle even the toughest job conditions with ease. Samsung Excavators can also be fitted with a wide range of buckets to increase productivity.

- **Smooth Simultaneous Operation** - Samsung's unique hydraulic system is designed to provide flexible operation in all five functions; travel, swing, bucket, boom and arm, while operating simultaneously. All operations remain smooth and fast throughout any work cycle.

- **Excellent Start-up in Cold Weather Conditions** - An electric air heater and fuel warmer are available as optional equipment. Heating the fuel prior to start-up prevents filter blockage for easier cold weather starts.

- **Working Stability** - A heavy counterweight provides excellent balance and stability with various work attachments such as hammers, speciality buckets and forestry fronts.

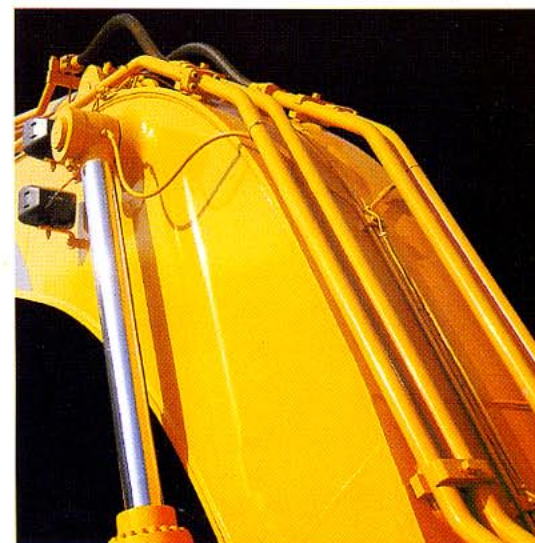

- **Increased Boom Durability** - The Boom has been reinforced to specifically handle tough job applications such as hydraulic breakers, crushers, grapples, shears, etc.

# Operator Comfort



Operator comfort is important in maintaining maximum productivity. That's why we've designed our cab with the operator in mind. Our ultramodern design is very comfortable and spacious and offers the additional benefits of conveniently located controls and reduced noise levels.

- **Removable Front Bottom Window** - Improved low angle visibility can be achieved by quick removal of the front bottom window.

- **Stereo/Cassette** - A high quality car stereo cassette provides excellent sound reproduction.

- **Overload Warning Device (Optional)** - The overload warning device is factory adjusted to reflect the 'over-the-side' lifting capacity of the Boom and Arm configuration of the machine.

- **Manual Control of Engine Speed** - Repositioning the lever mounted inside the cab allows easy transition to manual control.

- **Cab Noise Control** - To improve the operator's environment the cab is insulated with sound attenuating material. Successfully lowering intruding noise levels enhances operator performance, reduces fatigue and stress, paying greater dividends in safety.

- **Highest Visibility In The Industry** - The large curved front window offers remarkably increased visibility in the upper line of sight and is easily opened by sliding upward, to the overhead storage position.

- **Deluxe KAB Seat** - A deluxe KAB seat is installed as standard equipment, providing full adjustment for each operator's weight and size, resulting in the ultimate in operator comfort.

- **Interior Climate Control** - The conveniently placed keypad control panel for the integrated air conditioning/heating unit, allows the operator to optimise the cab temperature. With ease the comfort zone is maintained, utilising the multivalent distribution system for comfort and visibility regardless of weather conditions.



# Advanced Design Concept

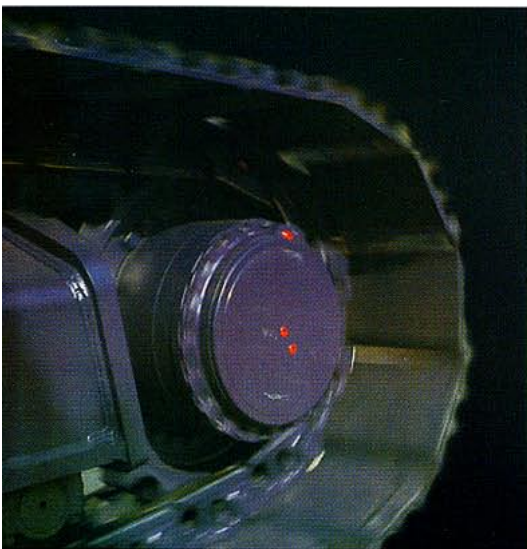

Samsung's Crawler Excavators have been computer-designed to provide greater structural integrity, stability and durability which will extend the service life of all major structural components.

- **Strong Undercarriage Components** - By increasing the hardness of the pins and bushings and improving the material composition of the links, rollers, idlers, and sprockets, we've added more usable life to our undercarriage.
- **Heavy Duty Track Guards** - Heavy duty track guards protect the lower rollers and prevent track disengagement on rough terrain.
- **Anti-slip Step** - Provides the operator with sure footing when entering or exiting the cab.
- **Two Speed Travel** - This feature allows the operator to travel in low gear when working in rough terrain or when slow movement is required and high gear for travel between job areas.

- **Hydraulic Safety Lock** - Raising the left side arm when leaving the cab immobilizes all controls levers, and helps to ensure operator safety.

- **Automatic Swing Brake** - The swing brake is automatically applied when the swing movement stops, preventing drift of the upper structure during slope operations.

- **Large Boom Lights** - Apart from the body head lights, separate large boom lights are installed to enhance the working conditions at night.

- **Reinforced Frames** - Both the upper and lower frames have been substantially reinforced for longer life.

# Easy Maintenance

The spacious engine room and lift-up side covers make access to the engine compartment fast and easy.

- **Engine Hood Locks** - Locks are installed on the engine hood and side doors to protect against vandalism.
- **Auto Fuel Pump (Option)** - Allows easier re-fueling when required.
- **Centralized Grease Injection Points** - Easier lubrication of the swing ring and attachments.
- **Cooling Water Auxiliary Tank** - Enables easy monitoring and replenishment of coolant by opening the side door.
- **Easy Bucket Adjustment** - The flange can be disassembled to adjust the bucket fit for extended life and less noise.
- **Precleaner (Option)** - Extends the air filter replacement period.

- **Simplified Hydraulics** - Samsung's Excavators utilise fewer hydraulic lines and hoses. As a result, maintenance is minimised and fewer parts are required.

- **Large Capacity Radiator** - The large capacity radiator provides excellent engine cooling and protects against overheating.

- **Self-Diagnosing Monitor System** - This system monitors 6 vital machine functions. If trouble occurs in one of these functions, the monitor will identify the problem eliminating the need for further troubleshooting procedures.

- **Easy Replacement of Bucket Teeth** - Samsung's bucket teeth are connected with a single side pin for quick and easy replacement.

- **Engine Cooling Fan** - The engine cooling fan is made of a tough plastic material to reduce noise while maintaining excellent air flow efficiency.



HEAVY INDUSTRIES



- **Easy Access Oil Filter** - The engine oil filter is conveniently located for easy access to inspect or change.



**SPECIFICATIONS** (General)

- **Operating Weight** 28,500kg
- **Bucket Capacity** 0.85-2.05m<sup>3</sup> 1.11-2.7yd<sup>3</sup> (SAE)
- **Engine**
  - Model Cummins 6CT 8.3-C
  - Type Water Cooled 6 Cylinder
  - Flywheel Horsepower 132.5kw at 1900rpm
  - Max. Torque 76kg.m at 1600rpm
  - Fuel Tank Capacity 430ℓ (95 UK gallons)
- **Hydraulics**
  - Type 2 Variable Axial Piston Pumps
  - System Pressure 320kg/cm<sup>2</sup>
  - Max. Flowrate 2 x 255 ℓ/min (2 x 56 UK gallons/min)
- **Performance**
  - Swing Speed 0 to 9.7rpm
  - Travel Speed 2.9 to 4.4km/h
  - Tractive Effort (1sp/2sp) 21,300/14,300kg
  - Ground Pressure 0.55kg/cm<sup>2</sup> with 600mm shoe  
0.42kg/cm<sup>2</sup> with 800mm shoe

**BACKHOE ATTACHMENTS**

**Characteristics**

The Boom and Arm are box type structures made of high tensile steel plates. All bushings are sealed against dust and dirt for increased lubrication intervals. High tensile strength, wear-resistance and welded steel buckets are used.

- Special heat treatment connections
- Two-point support-type boom cylinder
- Flanged bushing and O-ring at arm plus bucket connection.

**Bucket and Arm Digging Forces**

Arm length	3,000mm	2,500mm
<b>Bucket force</b>	16,600kg	16,600kg
<b>Arm force</b>	12,600kg	15,000kg

**MACHINE DIMENSIONS** (Based on Standard Machine)

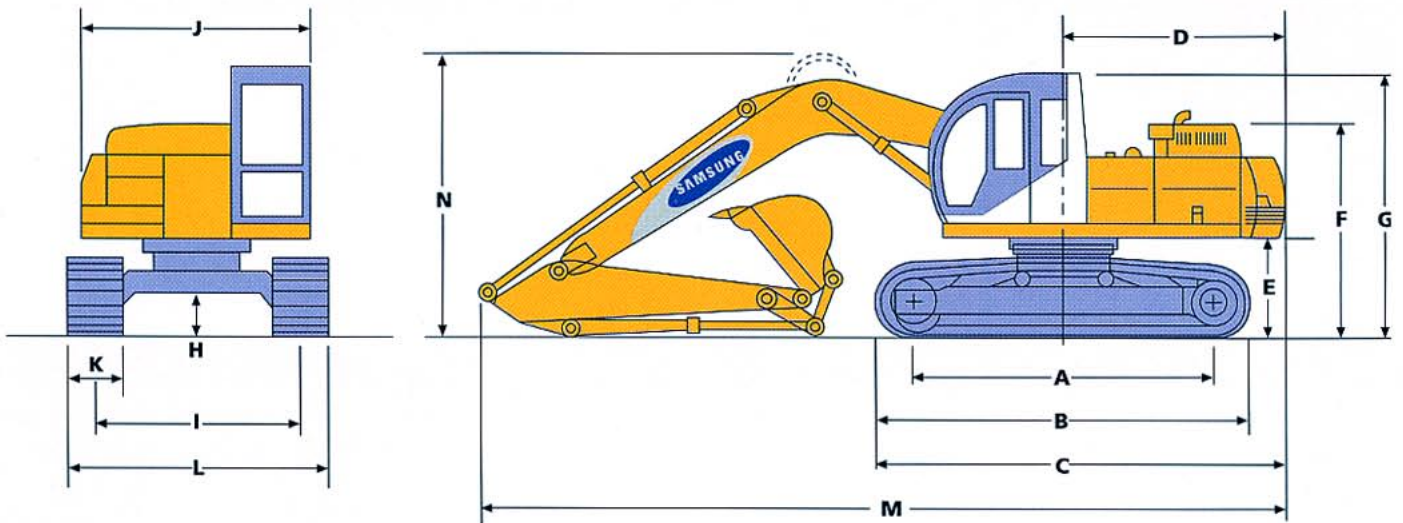

<b>A.</b> Distance Between Tumblers	4,020 mm	<b>I.</b> Track Gauge	2,590 mm 2,390 mm - (NLC)
<b>B.</b> Undercarriage Length	4,930 mm	<b>J.</b> Upper Frame Width	2,840 mm
<b>C.</b> Length of Base Machine	5,430 mm	<b>K.</b> Track Shoe Width	600 mm
<b>D.</b> Tail Swing Radius	2,970 mm	<b>L.</b> Overall Width	3,190 mm 2,990 mm - (NLC)
<b>E.</b> Counterweight Clearance	1,150 mm	<b>M.</b> Overall Length	10,540 mm
<b>F.</b> Height Without Cab	2,450 mm		(10,560) mm
<b>G.</b> Overall Height of Cab	3,050 mm	<b>N.</b> Overall Height of Boom	3,370 mm
<b>H.</b> Min. Ground Clearance	500 mm		(3,560) mm

All dimensions marked in *italics* are for the SE280NLC-2.  
\* Specifications may vary according to regional availability



**STANDARD AND OPTIONAL EQUIPMENT**

**STANDARD EQUIPMENT**

**Cabin**

- Sun Visor
- Sliding Side Window
- Seat
- Glove Box
- Coat Hook

**Instrument Panel**

- Engine Coolant Temp. Gauge
- Fuel Gauge
- Digital Clock
- Indicator Lights

**Miscellaneous**

- Car Stereo
- Ashtray
- Swing Lock
- Water Replenishment Tank
- Starting Aid System

- Lockable Door
- Sliding Front Window
- Hydraulic Safety Lock
- Control Box
- Removable Bottom Window

- Hyd. Oil Temp. Gauge
- Hour Meter
- Warning Lights

- Cigarette Lighter
- Horn
- Magazine Box
- Engine Auto Deceleration

**OPTIONAL EQUIPMENT**

**Cabin**

- FOPS

**Miscellaneous**

- Anti Drop Valves
- Air Conditioner
- Grease Gun
- Breaker Control System
- Tilting Bucket System

- Heater
- Tool Kit
- Under Plate
- Travel Alarm
- Overload Warning Device

**A:** Reach from swing centre

**B:** Bucket hook height





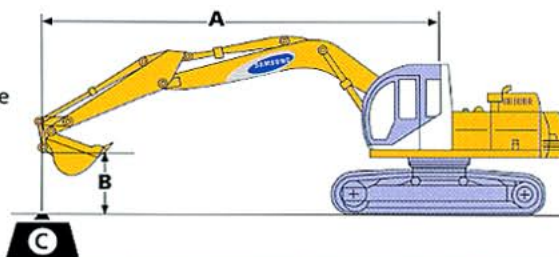









 Rating over front

 Rating over side



**LIFTING**

**CAPACITIES**

Boom and Arm Length	A	1.5m		3.0m		4.5m		6.0m		7.5m		9.0m		Max	
															
<b>Shoe 600mm</b>	<b>7.5m</b>	-	-	-	-	-	-	-	-	-	-	-	-	*4,045	*4,045
	<b>6.0m</b>	-	-	-	-	-	-	-	-	*5,026	4,765	-	-	*3,876	*3,876
<b>Boom 6.3m</b>	<b>4.5m</b>	-	-	-	-	*7,666	*7,666	*6,183	*6,183	*5,507	*4,647	-	-	*3,910	3,367
	<b>3.0m</b>	-	-	-	-	(*10,527)	(9,491)	(*6,183)	(*6,183)	(*5,507)	(4,357)	-	-	(*3,910)	(3,144)
<b>Arm 3.0m</b>	<b>1.5m</b>	-	-	-	-	*10,527	10,227	*7,556	6,490	*6,226	4,459	*4,867	3,152	*4,094	3,083
	<b>0m</b>	-	-	-	-	(*10,527)	(9,491)	(*7,556)	(6,068)	(*6,226)	(4,172)	(*4,867)	(2,938)	(*4,094)	(2,872)
<b>Bucket 0.85m³ 750kg (Std.)</b>	<b>-1.5m</b>	-	-	-	-	*12,824	9,486	*8,855	6,118	*6,970	4,269	5,161	3,077	*4,469	2,991
	<b>-3.0m</b>	-	-	-	-	(*12,824)	(8,774)	(*8,855)	(5,704)	(*6,970)	(3,985)	(5,333)	(2,863)	(*4,459)	(2,782)
<b>Bucket 0.85m³ 750kg (Opt.1)</b>	<b>0m</b>	-	-	-	-	*13,921	9,173	*9,768	5,878	6,900	4,129	-	-	*5,067	3,076
	<b>-1.5m</b>	-	-	-	-	(*13,921)	(8,470)	(*9,768)	(5,469)	(7,120)	(3,847)	-	-	(*5,067)	(2,861)
<b>Shoe 600mm</b>	<b>7.5m</b>	-	-	-	-	-	-	*5,248	*5,248	-	-	-	-	*5,448	*5,448
	<b>6.0m</b>	-	-	-	-	-	-	(*5,579)	(*5,579)	-	-	-	-	(*5,761)	(*5,761)
<b>Boom 6.3m</b>	<b>4.5m</b>	-	-	-	-	-	-	*5,646	*5,646	*5,524	4,603	-	-	*5,556	4,428
	<b>3.0m</b>	-	-	-	-	-	-	(*5,879)	(*5,879)	(*5,783)	(4,576)	-	-	(*5,817)	(4,411)
<b>Arm 2.5m</b>	<b>1.5m</b>	-	-	-	-	*8,535	*8,535	*6,685	*6,685	*5,882	4,522	-	-	*5,761	3,731
	<b>0m</b>	-	-	-	-	(*8,515)	(*8,515)	(*6,783)	(6,395)	(*6,071)	(4,424)	-	-	(*5,985)	(3,708)
<b>Bucket 0.85m³ 750kg (Opt.1)</b>	<b>-1.5m</b>	-	-	-	-	*8,002	6,329	*6,531	4,355	*6,645	(4,183)	-	-	5,637	3,386
	<b>-3.0m</b>	-	-	-	-	(*7,969)	(5,872)	(*6,645)	(4,183)	-	-	-	-	(6,031)	(3,346)
<b>Bucket 0.85m³ 750kg (Opt.1)</b>	<b>0m</b>	-	-	-	-	*9,186	5,995	*6,968	4,188	*9,186	(5,451)	(7,250)	(3,962)	5,507	3,279
	<b>-1.5m</b>	-	-	-	-	(*9,065)	(5,451)	(*9,065)	(5,451)	(7,250)	(3,962)	-	-	(5,867)	(3,213)
<b>Bucket 0.85m³ 750kg (Opt.1)</b>	<b>-1.5m</b>	-	-	-	-	*14,059	9,099	*9,877	5,803	6,845	4,078	-	-	5,707	3,389
	<b>-3.0m</b>	-	-	-	-	(*13,650)	(7,896)	(*9,778)	(5,225)	(7,098)	(3,828)	-	-	(6,041)	(3,284)
<b>Bucket 0.85m³ 750kg (Opt.1)</b>	<b>-1.5m</b>	-	-	-	-	*11,819	*11,819	*13,910	9,120	9,826	5,759	6,824	4,059	6,342	3,776
	<b>-3.0m</b>	-	-	-	-	(*11,058)	(*11,058)	(*13,531)	(7,962)	(9,936)	(5,191)	(7,096)	(3,826)	(6,656)	(3,612)
<b>Bucket 0.85m³ 750kg (Opt.1)</b>	<b>-3.0m</b>	-	-	-	-	*18,320	*18,320	*13,054	9,306	*9,624	5,857	-	-	7,794	4,660
	<b>-4.5m</b>	-	-	-	-	(*17,661)	(16,657)	(*12,720)	(8,205)	(*9,530)	(5,345)	-	-	(*7,910)	(4,395)
<b>Bucket 0.85m³ 750kg (Opt.1)</b>	<b>-4.5m</b>	-	-	-	-	*15,265	*15,265	*10,931	9,685	-	-	-	-	*8,448	6,941
	<b>-4.5m</b>	-	-	-	-	(*14,700)	(*14,700)	(*10,713)	(8,706)	-	-	-	-	(*8,423)	(6,435)

Note: 1. Ratings are based on SAE J1097, ISO 10567.  
 2. Indicated loads do not exceed 75% of tipping, machine situated on firm level, uniform supporting surface or 87% of full hydraulic capacity.  
 3. Ratings marked "\*" are limited by hydraulic capacity rather than tipping load.  
 4. Ratings marked in brackets are for the SE280NLC-2.



**WORKING RANGES AND BUCKET COMBINATIONS**

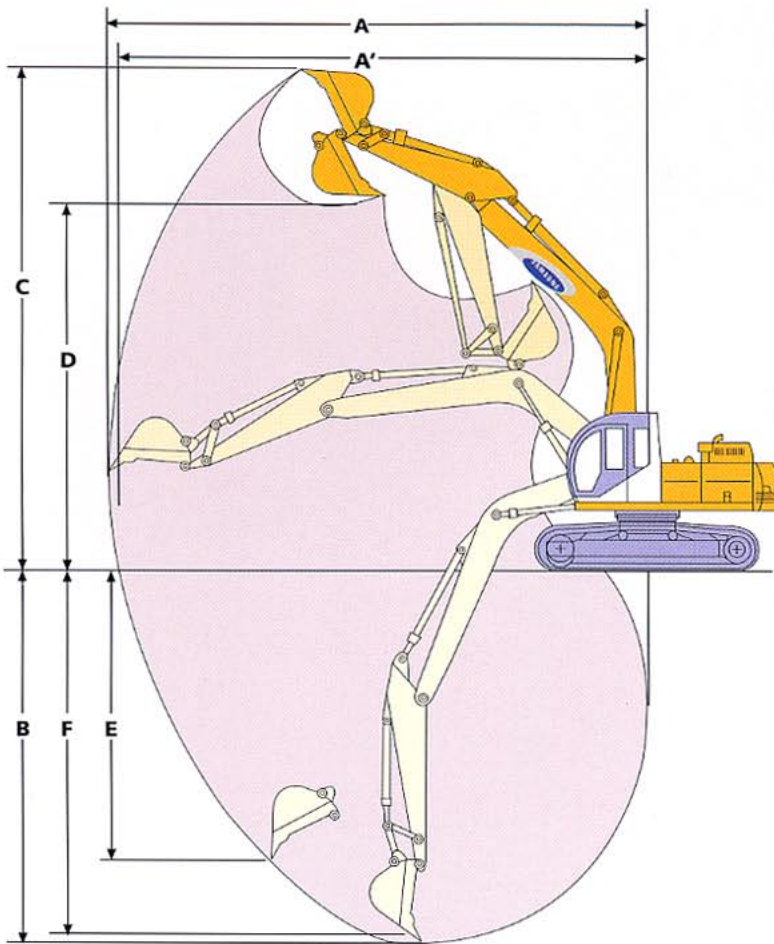

	Units	Std.	Opt. 1
Boom	m	6.3	6.3
Arm	m	3.0	2.5
A. Max. digging reach	mm	10,780	10,260
A'. Max. reach at ground level	mm	10,580	9,990
B. Max. digging depth	mm	7,500	6,960
C. Max. digging height	mm	10,160	9,820
D. Max. dumping clearance	mm	7,120	6,790
E. Vertical digging depth	mm	6,325	6,070
F. Digging depth at 8' - flat floor	mm	7,240	6,740
Bucket capacity (SAE heaped)	0.85m <sup>3</sup>	●	●
	1.25m <sup>3</sup>	■	●
	1.45m <sup>3</sup>	■	●
	1.65m <sup>3</sup>	▲	■
	2.05m <sup>3</sup>	▲	▲

- Suitable for materials with density of 2000kg/m<sup>3</sup> or less
- Suitable for materials with density of 1600kg/m<sup>3</sup> or less
- ▲ Suitable for materials with density of 1100kg/m<sup>3</sup> or less

**BUCKET SPECIFICATIONS**

Bucket capacity (SAE heaped)	Width with side cutters	Width without side cutters	Weight
0.85m <sup>3</sup>	900mm	775mm	750kg
1.25m <sup>3</sup>	1,200mm	1,075mm	998kg
1.45m <sup>3</sup>	1,350mm	1,225mm	1,122kg
1.65m <sup>3</sup>	1,500mm	1,375mm	1,248kg
2.05m <sup>3</sup>	1,800mm	1,675mm	1,497kg

**UNDERCARRIAGE FEATURES**

Tracks - Tractor type undercarriage, heavy duty track frame, all welded structure, high tensile strength steel used for toughness. Side frames are welded securely and rigidly to track frame. Lifetime lubricated track rollers, idlers and sprocket. Track shoes of rolled and heat-treated alloy steel with triple grousers. Specially heat-treated track pins, hydraulic track adjusters with shock-absorbing recoil springs.

	Units	600mm Shoe	700mm Shoe	800mm Shoe	Swamp Shoe	No. of Rollers and Shoes
Operating Weight	kg	28,500	29,030	29,410	29,550	-
Ground Pressure	kg/cm <sup>2</sup>	0.55	0.48	0.42	0.37	-
	psi	7.82	6.83	5.97	5.26	-
Shoe Length	mm	-	-	-	910	-
Upper Rollers	Each	-	-	-	-	2 x 2
Lower Rollers	Each	-	-	-	-	9 x 2
Track Shoes std.	Each	-	-	-	-	-
Track Shoes LC	Each	-	-	-	-	51 x 2



**HEAVY INDUSTRIES**

**THE NETHERLANDS**

**HEAD OFFICE – EUROPE**

LUIDSPREKERSTRAAT 1

1322AW ALMERE

THE NETHERLANDS

TEL: (+31) (0) 36 536 77 70

FAX: (+31) (0) 36 536 09 70

**FRANCE**

PARIS NORD II

305 RUE DE LA BELLE ETOILE

BP50279

95958 ROISSY CDG CEDEX

FRANCE

TEL: (+33) (0) 148 630691

FAX: (+33) (0) 148 630698

**GERMANY**

AM KRONBERGER HANG 6

65824 SCHWALBACH / TS.

GERMANY

TEL: (+49) (0) 6196 667640

FAX: (+49) (0) 6196 667633

**UK OFFICE**

TELFORD WAY

KETTERING

NN16 8UX

UNITED KINGDOM

