

VOLVO WHEEL LOADER

L350F



MORE CARE. BUILT IN.



VOLVO – A PARTNER TO TRUST

L350F is a wheel loader that never compromises. As a whole, the machine combines the lift arm system and attachments which make up a dynamic unit, a solid combination of power and intelligence. It's fast, smooth, and stable, and lifts both high and heavy. A durable loader that handles the toughest jobs, around the clock, day or night.

Increase your profitability

The bigger the machine, the tougher the demands on reliability. In fact, a big loader like the L350F is like a factory on wheels and requires a business-like approach where revenues far outweigh costs. In light of this, you'll be glad to know that in most applications, the L350F is more fuel-efficient than other machines in its class. Throw in reliability and you're looking at outstanding economy and productivity. All together a significant increase in profitability.

A global company with local presence

When you buy a Volvo L350F, you not only get one of the most reliable wheel loaders on the market. With our global dealer and service network you also get Volvo Construction Equipment as your reliable and committed partner. Wherever you are, you get fast access to well-trained service personnel and the right parts. In short, all the products, services, and knowledge you need to optimize your machine's profitability and productivity.

Specifications	L350F
Engine:	Volvo D16E LA E3
Max power at	28,3–30,0 r/s (1700–1800 rpm)
SAE J1995 gross:	397 kW (540 metric hp)
ISO 9249, SAE J1349 net:	394 kW (535 metric hp)
Breakout force:	472,8 kN*
Static tipping load at full turn:	34 290 kg*
Buckets:	6,2–12,7 m ³
Log grapples:	5,5–6,3 m ²
Operating weight:	50,0–56,0 t
Tires:	35/65 R33 875/65 R33

* Rock bucket: 6,9 m³ straight edge with teeth and segments,
Tires: 875/65 R33, Standard boom





STRENGTH THAT MAXIMIZES YOUR INCOME

The Volvo L350F gives you a way to move more tons per hour. The powerful engine combined with the fully automatic transmission gives instant response even at the lowest engine speed, and Volvo's drivetrain always promotes maximum power when and where it's needed most. The result is maximal productivity and lowest possible cost per ton.

Full power even at idle speed

With Volvo's new engine generation, Volvo wheel loaders have become both more powerful and easier to operate. The L350F responds immediately with its 540 hp, electronically controlled low-emission engine, which delivers full power even at low rpm.

Always the right gear

Volvo's planetary transmission features smooth shifting with automatic Lock-Up. All the operator has to do is to select forward or reverse, and then Automatic Power Shift (APS) automatically selects the right gear to suit current engine revs and ground speed.

Volvo's drivetrain provides top reliability

Volvo's drivetrain components are tailored to match each other and dimensioned to provide top reliability. On the L350F, the rear axle is mounted in a maintenance-free axle cradle, which means that the operator doesn't have to carry out lubrication and there is no downtime.

Gentle and powerful brakes

The Volvo L350F is equipped with Volvo's hydraulically operated, axle oil-cooled wet disc brakes. This system is both powerful and gentle in operation, while ensuring long service life.

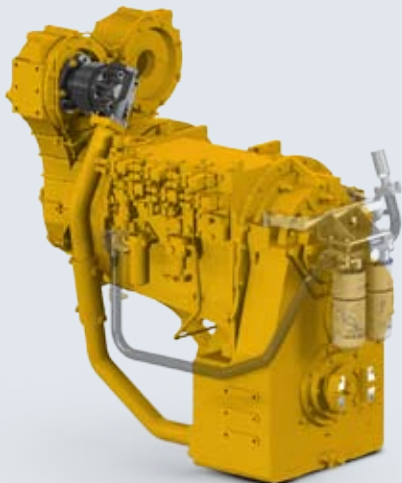

Volvo Engine D16E V-ACT

Volvo's engines feature Volvo Advanced Combustion Technology, V-ACT, an emission-controlling solution based on simple yet proven technology

The turbocharged D16E with air-to-air intercooling features both electronically controlled fuel injection and hydrostatic variable-speed cooling fan and overhead camshaft with four valves per cylinder

Volvo HTE 400 Heavy-Duty Transmission

Volvo's planetary transmission features smooth shifting with automatic Lock-Up in second, third, and fourth gears, saving fuel to reduce costs

The 4th generation APS featuring automatic mode selector allows the operator to choose between four different gear shifting programs – these features save fuel and promote higher productivity

The transmission automatically downshifts to first gear when needed

Volvo AHW 90 Heavy-Duty Axles

Outboard-mounted wet disc brakes and planetary hub reductions increase lateral stability, optimize oil-cooling and simplify serviceability

Lifetime-lubed rear axle mounting never needs greasing

Volvo Brakes

The fully hydraulic dual circuit service brakes increase site safety and the system can automatically apply the parking brake in case of engine shutdown or if brake pressure is too low

Hydraulic dual circuit system for enhanced safety

Oil circulation-cooled axles with filters ensure effective braking and a long service life



POWER WITH PRECISION

With its lift arm system, load-sensing hydraulics, easily operated steering and high stability, the L350F allows the operator equal measures of power and precision. The load-sensing hydraulic system ensures that hydraulic oil is pumped around the system only when and where it's needed, providing higher efficiency and lower fuel consumption.

No power loss through the loading cycle

The lift arm system delivers high breakout torque at ground level, allowing the operator to handle heavy material without any power loss at any point in the loading cycle. This is one of the reasons why the L350F is an exceptionally efficient production machine.

Powerful and intelligent

The L350F features an intelligent load-sensing hydraulic system. Two variable piston pumps provide exactly the flow rate and pressure required at any given moment in time, distributing the power where it's needed, when it's needed. When flow is not required in the hydraulic system, all engine power is diverted to the drivetrain. This provides smoother operation, lower fuel consumption, and more precise control of machine and load. You always get full power, regardless of revs.



Well-designed steering with precision makes it easy to maneuver

Steering is easy even at low rpm. The load-sensing hydrostatic steering system is activated only when the steering wheel is turned, resulting in a highly efficient system where there is no waste of power or fuel. The electro-hydraulic steering with Comfort Drive Control (CDC) is easily operated and precise, and is stable over the whole speed range. Furthermore, the CDC features an end-stroke damping that provides smooth, full-range steering and eliminates frame shocks that may occur during quick turns.

Volvo Lift Arm System

Volvo's proven lift arm system provides outstanding breakout force

Improved lift arm geometry allows for exceptional attachment visibility

Dual pin seals reduce wear for improved durability and long service life

Volvo Load-Sensing Hydraulics

Electro-hydraulic load-sensing system includes variable displacement piston pumps to provide flow and pressure, delivering power where and when it's needed, which means better fuel-efficiency

Volvo's Boom Suspension System (BSS)* features two operating modes and is designed with heavy-duty shock accumulators that promote faster, more comfortable work cycles, boosting productivity by up to 20 percent

Volvo Steering

Steering by steering wheel:

- Load-sensing steering only uses power when it's needed, thereby saving fuel.
- An accumulator system provides operator comfort and increased productivity.

Steering by CDC:

- Significantly reduces repetitive steering wheel movements by integrating fingertip controls into the left armrest, helping to lower operator fatigue while increasing productivity and operator comfort.
- Speed-sensitive steering provides precision in any application.
 - An accumulator system provides operator comfort and increased productivity.
 - End-stroke damping improves operator comfort, increases productivity and component reliability.

Volvo Frames

Volvo's world-class frames resist high stresses and provide superior operational stability, reduce vibrations, and promote low sound levels

Well-designed articulation joint not only looks good, it also provides component and frame reliability – with widely spaced bearings, the frame resists higher forces, preventing expensive line boring and increasing bearing service life

*Optional equipment



SUSTAINED ENDURANCE – YEAR AFTER YEAR

With big loaders, availability is everything. If the machine stops, work stops. That's why the L350F is designed, down to the smallest detail, to work without downtime, no matter how hard you push it. For example, Volvo uses filters on all expensive and vital components to prevent costly downtime and repairs. It's built to run.

Volvo – a quality concept in itself

Before a new machine generation is launched on the market, every vital component and newly designed system has been individually durability and fatiguetested in test rigs. Only after passing that stage are they ready to meet the world's toughest test environment – the customers' reality – for thousands of hours in our prototypes and pre-series machines. The test hosts provide their feedback and comments about every detail directly to Volvo's engineering department. Volvo's Reliability Growth test technology means more test hours, improved measuring precision, and predictability in quality assurance. Volvo is a quality concept in itself. We set our goals a little higher.

High resale value and long service life

The Volvo L350F is not just one of the most productive loaders on the market; it's also one of the most cost-effective. There are several reasons for this – Volvo's renowned reliability, our beneficial financing packages, the low fuel consumption, the high resale value, and the minimal service requirement. All this makes it the most productive and reliable machine in the business. Shift after shift, year after year.

Four levels of support, one level of care

Your machine should be profitable, not only today but tomorrow as well. At Volvo we have an extensive range of different tools, programs, and service agreements ensuring that your Volvo will give you optimal usage and profitability for a long time ahead. The best way to get the most out of your Volvo is to invest in a Volvo Customer Support Agreement. Since different businesses have different needs, we've made it easy for you to select the Customer Support Agreement that's right for your business by creating four Customer Support Agreement packages – from a program of regular machine inspections to a comprehensive repair and maintenance program, which means that there is no need for an on-site workshop.



Air from all the major components is vented through easily replaced filters, preventing dirty air from entering the transmission, axles, fuel tank and hydraulic tank

Volvo's oil-bath pre-cleaner* in combination with the standard air filter is far more effective in dusty and dirty operating conditions

All electrical cables are well protected against water, dirt and chafing, routed in sturdily attached conduits with rubber-sealed connectors and terminal caps – all the most vital components are well protected inside the cab

Volvo Reliability Growth (RG) tests for high quality during thousands of hours

Volvo designed and engineered rear axle trunnion is maintenance-free and lubed for life

A brake with two-level warning for high axle oil temperature provides effective component protection and longer service life.

*Optional equipment



PROTECTION TO STAY FOCUSED IN OPERATION

Volvo has designed wheel loaders since 1954. Right from the beginning we put safety first, and we have used all the experience and knowledge we have amassed throughout these years to make the L350F as safe as possible. But not at the expense of comfort, operating joy, and power. Quite the opposite. We know that safety and productivity partly is the result of a satisfied operator – man and machine in perfect harmony.

Generous space

You really feel welcome in Volvo's latest cab. It's both wider and deeper than its predecessor. There is lots of space to stretch out your legs, and ample space for storage boxes, boots, and cups. The comfortable seat suits operators of all sizes. The large, swept windshield gives optimized visibility in every direction, up high as well, making it easy to load even with Long Boom*. To facilitate communication with others on the site, there are sliding windows on both sides**. All instruments are easy to read, and on the right side all buttons are very easily accessible on a sturdy aluminum pillar.

Always a comfortable climate

Volvo's unique and patented two-stage air cleaning recirculates up to 90 percent of the air, and only 10 percent comes from the outside. The air in the cab is cleaned to 98 percent. Automatic Climate Control (ACC) is standard and ensures an always comfortable climate in the cab, regardless of weather and temperature. And if the operator needs a break, the heat can be left on even with the engine off*, which both saves fuel and protects the environment.



Volvo Care Cab

Volvo's world class operator's environment features a larger, more spacious interior, large storage compartments, front pillar-mounted switches and in-cab adjustable return-to-dig, boom kick-out and bucket position detents

From the fully adjustable operator's seat, armrest and steering column to the floor-to-ceiling front windshield, long shifts have never been so comfortable, and with the new viscous cab mounts unwanted noise and vibrations are further dampened

The Volvo Care Cab pressurizes and filters all incoming air twice, promoting a clean interior and a healthy, happy operator – Automatic Climate Control promises consistent cab temperatures throughout the entire shift

Unobstructed 360 degree visibility defines the Volvo Care Cab; a wide laminated windshield, large windows, narrow ROPS-pillars with a low reinforcement frame and optimized visibility over all attachments help increase productivity – night work is simplified with the powerful front and rear halogen lights which provide proper coverage for the operator

* Optional equipment

** Door side is optional





REAL-TIME INTELLIGENCE SUPPORTING 24/7 UPTIME

Few machines work as hard and in as tough environments as the bigger wheel loaders. In order to keep stops as short and few as possible, Volvo provides warranties and service systems that are tailored to your machine and suited to the toughest imaginable operating conditions, thereby reducing downtime and maximizing uptime.

Service-friendliness means more time to work

Volvo assists you in your daily maintenance by providing simple and quick electronic checks of oil and fluid levels. All filters and service points are easily accessible. All the hatches are large and easy to open. Pressure check connections and quick-couplings are conveniently grouped for fast and simple inspection.

CareTrack* - on track and in control

With CareTrack installed in your L350F, you can concentrate on your core business while your Volvo Dealer takes care of your machine. CareTrack allows you to remotely monitor your machine's fuel economy and performance, shift by shift. The system also allows your Volvo Dealer to monitor the machine's condition, checking for problems from many miles away. Service mechanics can get service reminders,

analyze error codes**, and start problem-solving before making maintenance visits. Using the CareTrack mapping and Geo-fence functions, it's easy to locate the machine, and to prevent unauthorized use. It all adds up to increased peace of mind.

Let Contronic take control

The L350F's operation and performance are controlled by a built-in and highly reliable electronic network, Volvo Contronic. It works on three levels; the system keeps an eye on the machines' functions in real-time, and a service technician can connect the Contronic service tool to the system and troubleshoot directly on the site. All operational data is stored and can be used to analyze the machines' performance and trace its history since the most recent service. The machines' functions can be optimized according to changes in operating conditions via the Contronic service display, and machine functions can be adapted to suit changing conditions.



Contronic electronic monitoring system

Over-riding computerized electronic and monitoring system, dependable and easy to use

Coordination of reliable engine and machine computers for optimum performance and safety

Display information in three categories – current operating data, warning texts and error messages

Available in 24 languages, monitors fuel consumption, cycle times and service intervals

The system has built-in safety functions that automatically limit the engine's torque and power output in case of major malfunctions in order to protect the engine and transmission, thus reducing the risk of subsequent damage

Maintenance and uptime

Electronic monitoring of fluid levels simplifies and reduces the time needed for daily inspections, and enhances reliability

Long lubrication intervals mean more time for productive work

Easily accessible hatches and service points make service easier

Anti-slip service platforms, wide and angled cab ladders and conveniently located handrails provide safe movement around the machine

CareTrack* advanced telematics

GPS positioning, mapping, Geo- & Time-fence functions monitor your machine fleet

GPRS and/or Satellite transfer of operating data, error codes**, logged machine data**

Service reminders and alarms, including forwarding by E-mail and text message

* Optional equipment

** Only available with CareTrack Advanced



A MACHINE YOU CAN ALWAYS TRUST

Access and Serviceability

- Easily accessed hatches and service points
- Centralized, ground level lubrication banks and grouped pressure check connections
- Lubricated-for-life rear axle bearings
- Slip protected service platforms, handrails, wide and angled cab ladders provide safety
- Long lubrication intervals allow more time for productive work

Volvo Lift Arm System

- Lift arm system provides superior force throughout the lift cycle
- Increase in dump height increases loading efficiency
- Optimized attachment visibility and great rollback angles
- Dual pin seals prevent contamination of pins

Commitment to Volvo's Core Values: Quality, Safety, and Care for the Environment

- Roll Over Protection System (ROPS) provides safe operation
- Non-return valves prevent leakage of both hydraulic and fuel tanks in case of roll-over
- High-quality breather filters on all major components
- Optional biodegradable hydraulic oil allows environmentally-friendly operation
- All Volvo wheel loaders are more than 95% recyclable
- All electrical wiring is routed through high-quality conduits with sealed connectors

World-Class, Volvo Care Cab

- Larger, more spacious cab interior with large storage compartments
- Care Cab features the market's best cab filtration system
- Front pillar-mounted switches
- In-cab adjustable bucket and boom detents
- Fully adjustable operator's seat, armrest, lever carrier, and steering column
- Improved allround visibility includes wide, laminated front windshield and floor-to-ceiling glass
- Viscous damping helps to eliminate unwanted noise and vibrations



Volvo Load-Sensing Hydraulics

- Electro-hydraulic, load-sensing system provides exact flow and pressure where and when it's needed
- Faster cycle times and increased lift force
- Speed-sensitive CDC provides high precision in any application
- CDC with end-stroke damping improves operator comfort, increases productivity and component reliability



Volvo Contronic Monitoring System

- Network monitors operation and performance in real-time
- The Contronic system warns the operator in time, troubleshoots for the service technician, and helps the machine owner to adapt the wheel loader to the application
- Fast and easy electronic level checks of oils and fluids
- Display shows continuous operating data, warning texts, and error messages
- Monitors fuel consumption, cycle times, and service intervals
- Available in 24 languages

Volvo Designed and Manufactured Engine

- Turbocharged Volvo V-ACT D16E, Tier 3/Stage IIIA-approved D16E provides tremendous power and impressive low-end torque
- Couples outstanding fuel economy, high reliability, and durability with low levels of noise and exhaust emissions
- Engine control with overspeed protection for optimal performance in all operating conditions
- Hydrostatically driven, electronically controlled fan works only when needed, which saves fuel

Volvo HTE 400 Heavy-Duty Transmission

- Automatic Power Shift (APS) with automatic mode selector
- The transmission automatically downshifts to first gear when needed
- Smooth shifting planetary transmission with automatic Lock-Up in second, third, and fourth gears

Volvo AHW 90 Heavy-Duty Axles

- Dual circuit service brakes and automatic parking brake application
- Outboard-mounted wet disc brakes and planetary reductions
- Optional axle oil cooling provides maximized cooling capacity*
- Brake wear indicators on each hub simplifies monitoring of brake pad wear

Volvo Frames

- High-quality steel provides stress resistance and operational stability
- Low vibrations and incredibly quiet sound levels
- Well-organized articulation joint provides visual appeal and reliability
- Upper and lower joints are designed to resist large forces

* Optional equipment

GROWTH IN HARMONY WITH THE ENVIRONMENT

Volvo's core values are quality, safety, and environmental care. We regard our commitment to the environment as a natural part of our entire operation, the goal of which is to maximize productivity and efficiency at the lowest possible cost and minimal environmental impact. With the L350F, you get one of the market's cleanest and most reliable wheel loaders.

Powerful, dependable, and environmentally optimized

With the new generation of diesel engines, Volvo has taken yet another giant stride ahead to reduce emissions, without any dramatic changes that reduce engine power. This is possible thanks to the new V-ACT (Volvo Advanced Combustion Technology). The system's secret lies in its advanced method of fuel injection, its enhanced electronic control of engine operation, and its smart system of exhaust gas recirculation. This new engine makes the L350F more environmentally optimized, without affecting fuel consumption.

More than 95 percent recyclable

Volvo wheel loaders are almost entirely recyclable. Components such as the engine, transmission, and hydraulic system are re-engineered and reused in our Parts Exchange Program. For us, this is an obvious and natural part of our undertaking.

Quality

All major components including transmission, axles, fuel tank, and hydraulic tank are well-protected from contamination with high-quality breather filters, only replaced every 2000 hours to ensure long machine life and prevent oil misting. All electrical wiring is routed through high-quality conduits with rubber-sealed end connectors, providing true protection from water, dust, vibration and abrasion.

Safety

Dual circuit wheel brake system
Electronic brake testing in Contronic
The parking brake is activated automatically when the engine is switched off
The Volvo Care Cab has been tested and approved according to the requirements in ROPS ISO 3471 and FOPS ISO 3449
Warning signs offer clear information in the form of symbols and illustrations
Optimized allround visibility gives effective control over the entire working area
All steps and platforms are provided with a slip protected surface, as well as well-positioned handrails

Environment

Volvo wheel loaders are manufactured in environmentally certified factories according to ISO 140001
The Volvo D16E engine meets all existing emission requirements according to Stage IIIA and Tier 3
The load-sensing hydraulic system contributes to low fuel consumption
Optional biodegradeable hydraulic oil allows environmentally-friendly operation
All Volvo wheel loaders are more than 95% recyclable with all plastic parts marked according to ISO standards to simplify recycling
Low interior and exterior noise levels



VOLVO GENUINE ATTACHMENTS – FOR A PERFECT MATCH

Volvo wheel loaders are renowned for their high quality and Volvo's genuine attachments offer exactly the same high quality. This is actually an absolute precondition for our machines to deliver what we promise – the highest possible productivity. Machines and attachments that are made for each other work best together.

Best penetration capability and long service life

Genuine Volvo attachments are durable and last up to three times as long as some other makes. This high quality stems partly from our long experience and partly from our close cooperation with some of the world's best material manufacturers. The high quality also applies to the bucket's wear parts. Their design and the materials from which they are made give Volvo's edge savers, teeth, and segments the best penetration capability, long service life, and short time for replacement of wear parts.

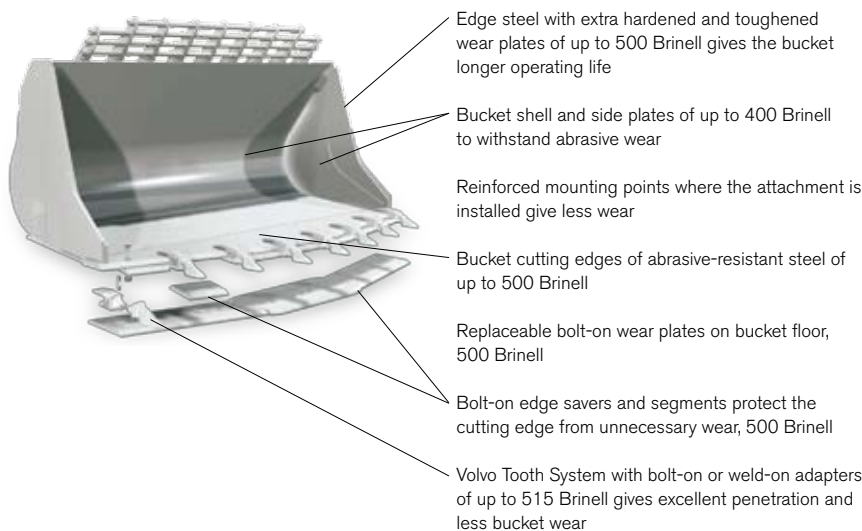

Spade nose rock bucket with teeth and segments



Straight edge rock bucket with teeth and segments



Side-dump bucket with bolt-on edges



General purpose bucket with bolt-on edges



Light material bucket with bolt-on edges



Block handling fork

VOLVO OPTIONAL EQUIPMENT BOOSTS YOUR PROFIT



Selection of Volvo optional equipment

Long boom

A long boom gives the extra dump height and reach necessary for loading high trucks or feeders. The additional reach also gives added protection when loading the bucket by keeping the machine farther away from the material.

Boom Suspension System (BSS)

BSS utilizes gas/oil accumulators connected to the lift cylinders to absorb shocks and smooth out rough roads for faster cycle times, less spillage, and increased operator comfort.

3rd hydraulic function

3rd hydraulic function enable use of hydraulically attachments.

Automatic Lubrication System

Our factory-installed Automatic Lubrication System takes care of greasing while the machine is in operation. This means less downtime for scheduled maintenance and more time for productive work.

Mudguards

Swing-out rear mudguards – to protect the machine in extreme conditions. Permit rear boarding.

Rear-view camera system

Rear-view camera system reduces blind spots and increases site safety when reversing and also improves operator comfort.

Limited Slip

Volvo's Limited Slip differentials provide dependable traction in tough ground conditions, which reduces tire slip and simplifies operation.

Engine air pre-cleaners

Volvo's own oil-bath pre-cleaner is available for increased purification of the engine induction air. In addition to increased cleaning capacity, these air pre-cleaners extend service intervals, thereby reducing maintenance time.

CareTrack telematics system

Remote monitoring of the machine's position, utilization, and performance. Forwarding of error codes, alarms, and service reminders. Position on map plus Geo & Time-fence functions.

VOLVO L350F IN DETAIL



Engine

Engine: V-ACT Stage III A/Tier 3, 16 liter, 6-cylinder in-line turbo-charged, air-to-air intercooler diesel engine with double rockers and Internal Exhaust Gas Recirculation (I-EGR). One-piece cylinder head with four valves per cylinder and one overhead camshaft. The engine has wet replaceable cylinder liners and replaceable valve guides and valve seats. Mechanically actuated electronically controlled unit injectors. The throttle application is transmitted electrically from the throttle pedal. **Air cleaning:** Three stage cyclone pre-cleaner - primary filter - secondary filter. **Cooling system:** Hydrostatic, electronically controlled fan and intercooler of the air-to-air type.

Engine	Volvo D16E LAE3
Max power at	28,3-30,0 r/s (1700-1800 r/min)
SAE J1995 gross	397 kW (540 metric hp)
ISO 9249, SAE J1349 net	394 kW (535 metric hp)
Max torque at	23,3 r/s (1400 r/min)
SAE J1995 gross	2550 Nm
ISO 9249, SAE J1349 net	2532 Nm
Economic working range	1000-1500 r/min
Displacement	16,1 l

Drivetrain

Torque converter: 3-element, 1-stage, 1-phase torque converter with Lock-Up function and free-wheel stator. **Transmission:** Planetary Power Shift transmission with full modulated electronically controlled shifting of 4 gears forward and reverse. Volvo Automatic Power Shift (APS) gear shifting system with fully automatic shifting 1-4 (Lock-Up in 3-4) and mode selector with 4 different gear shifting programs, including AUTO mode. **Axes:** Fully floating axle shafts with planetary-type heavy-duty hub reductions. Fixed front axle and oscillating rear axle. **Optional:** Limited Slip differentials in front and rear axle.

Transmission	Volvo HTE 400
Torque multiplication, stall ratio	2,65
Maximum speed, forward/reverse	
1st gear	6,8 / 7,5 km/h
2nd gear	12,1 / 13,2 km/h
3rd gear	21,0 / 22,9 km/h
4th gear	35,7 / 38,2 km/h
Measured with tires	35/65 R33 L4
Front axle/rear axle	Volvo AHW 90/AHW 90
Rear axle oscillation	±12°
Ground clearance at 12° osc.	550 mm

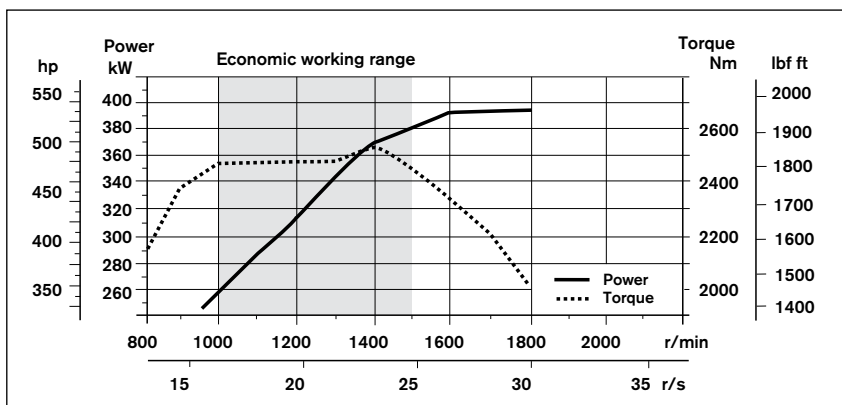



Electrical System

Central warning system: Contrinsic electrical system with central warning light and buzzer for following functions: - Serious engine malfunction - Low steering system pressure - Overspeed warning engine - Interruption in communication (computer error) Central warning light and buzzer with gear engaged for the following functions: - Low engine oil pressure - High engine oil temperature - High charge-air temperature - Low coolant level - High coolant temperature - High crankcase pressure - Low transmission oil pressure - High transmission oil temperature - Low brake pressure - Engaged parking brake - Brake charging failure - Low hydraulic oil level - High hydraulic oil temperature - Overspeeding in engaged gear - High brake cooling oil temperature front and rear axles.

Voltage	24 V
Batteries	2x12 V
Battery capacity	2x170 Ah
Cold cranking capacity, approx.	1000 A
Reserve capacity	330 min
Alternator rating	2280 W/80 A
Starter motor output	7,0 kW (9,5 hp met.)

Brakes

Service brake: Service brakes are dual circuit all-hydraulic multi-disc brakes with nitrogen-charged accumulators and automatic slack adjusters. Outboard-mounted oil-cooled, wet disc brakes at each wheel. Transmission disengagement during braking can be preselected in Contrinsic. **Parking brake:** Wet multi-disc type in transmission housing. Spring-applied, electro-hydraulically released with a switch on instrument panel. Applies automatically when the key is turned off. **Secondary brake:** Dual circuit axle-by-axle system. Actuated by service brake pedal. Low pressure alarm. Dead engine braking capability provided by three nitrogen-charged accumulators. **Standard:** The brake system complies with the requirements of ISO 3450:1996.

Number of brake discs per wheel	11
Accumulators	6x1,0 l
Accumulators for parking brake	1x0,5 l

Cab

Instrumentation: All important information is centrally located in the operator's field of vision. Display for Contrinsic monitoring system. Heater and defroster: Heater coil with filtered fresh air, fan with auto function and 11 manually selectable steps, defroster vents for all window areas. **Operator's seat:** Operator's seat with adjustable suspension and retractable seatbelt. The seat is mounted on a bracket on the rear wall and floor. The forces from the retractable seatbelt are absorbed by the seat rails. **Standard:** The cab is tested and approved according to ROPS (ISO 3471, SAE J1040), FOPS (ISO 3449). The cab meets with requirements according to ISO 6055 ("Operator overhead protection - Industrial trucks") and SAE J386 ("Operator Restraint System").

Sound level in cab according to ISO 6396	LpA 72 dB (A)
External sound level according to ISO 6395	LwA 111 dB (A)
Ventilation	9 m ³ /min
Heating capacity	13 kW
Air conditioning	8 kW

Lift arm system

Z-bar linkage system with high breakout forces. The lift arms are single plate construction with a high-strength steel cast cross tube. The single bell crank and bucket link are nodular iron castings.

Lift cylinders	2
Cylinder bore	200 mm
Piston rod diameter	110 mm
Stroke	1264 mm
Tilt cylinder	1
Cylinder bore	260 mm
Piston rod diameter	120 mm
Stroke	728 mm

VOLVO L350F IN DETAIL



Hydraulic System

System supply: Two load-sensing axial piston pumps with variable displacement. The steering function always has priority from one of the pumps. **Valves:** Double-acting 2-spool valve. The main valve is controlled by an electric pilot. **Lift function:** The valve has four positions; lift, hold, lower, and float position. Inductive/magnetic automatic boom kickout can be switched on and off and is adjustable to any position between maximum reach and full lifting height. **Tilt function:** The valve has three functions; rollback, hold, and dump. Inductive/magnetic automatic bucket positioner can be switched on and off. **Cylinders:** Double-acting cylinders for all functions. **Filter:** Full-flow filtration through 20 micron (absolute) filter cartridge. **Hydraulic oil cooler:** Air-cooled oil cooler mounted on radiator.

Working pressure maximum, pump 1	25,0 MPa
Flow at engine speed	256 l/min 10 MPa 30 r/s (1800 r/min)
Working pressure maximum, pump 2	26,0 MPa
Flow at engine speed	354 l/min 10 MPa 30 r/s (1800 r/min)
Working pressure maximum, pump 3	26,0 MPa
Flow at engine speed	84 l/min 10 MPa 30 r/s (1800 r/min)
Cycle times	
Raise*	8,0 s
Tilt*	1,9 s
Lower, empty	4,7 s
Total cycle time	14,6 s

* with load according to ISO 14397 and SAE J818

Steering System

Steering system: Load-sensing hydrostatic articulated steering with an accumulator system and a non-pressurized tank. **System supply:** The steering system has priority feed from a load-sensing axial pump with variable displacement. **CDC:** Speed-dependent electro-hydraulic power steering system with closed center hydrostatic back-up and end-stroke damping.

Steering cylinders	2
Cylinder bore	110 mm
Rod diameter	70 mm
Stroke	586 mm
Working pressure	26,0 MPa
Maximum flow	354 l/min
Maximum articulation	±37°

Service

Service accessibility: Large, easy-to-open service doors with gas struts. Swing-out radiator grill. Fluid filters and component breather filters promote long service intervals. Possibility to monitor, log, and analyze data to facilitate troubleshooting.

Refill capacities	
Fuel tank (total)	660 l
Fuel, usable	620 l
Engine oil	40 l
Engine coolant	68 l
Transmission oil	79 l
Axle oil front/rear	155 l
Hydraulic oil tank	365 l



SPECIFICATIONS

Tires: 35/65 R33 RL5K L5 Goodyear

	Standard boom	Long boom
B	9130 mm	9560 mm
C	4300 mm	-
D	550 mm	-
F	4180 mm	-
F ₁	3980 mm	-
F ₂	3220 mm	-
G	2130 mm	-
J	4920 mm	5400 mm
K	5340 mm	5810 mm
O	60 °	58 °
P _{max}	46 °	-
R	43 °	45 °
R ₁ *	49 °	50 °
S	66 °	72 °
T	120 mm	130 mm
U	660 mm	770 mm
V	3970 mm	-
X	2720 mm	-
Y	3630 mm	-
Z	4230 mm	4650 mm
a ₂	8240 mm	-
a ₃	4610 mm	-
a ₄	±37 °	-

* Carry position SAE

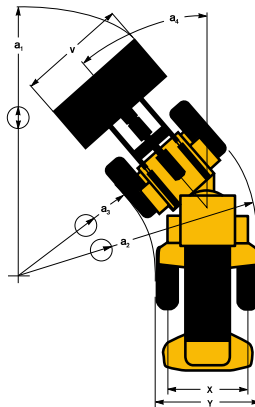

Where applicable, specifications and dimensions are according to ISO 7131, SAE J732, ISO 7546, SAE J742, ISO 14397, SAE J818.

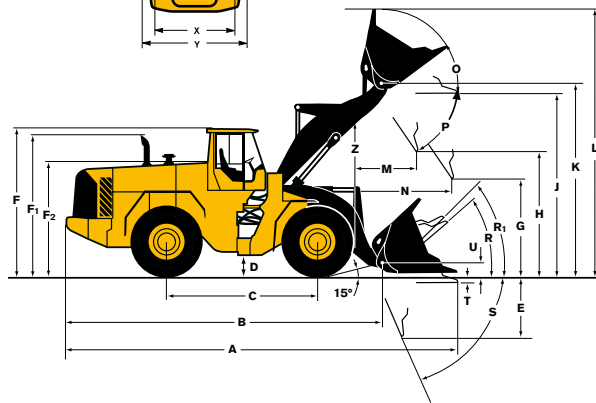

Supplemental Operating Data

35/65 R33 RL5K L5 Goodyear	Width over tires (mm)	Ground clearance (mm)	Operating weight (kg)	Static tipping load, full turn (kg)	
				Standard boom	Long boom
35/65 R33 XLD D1 L4 Michelin	+10	-20	-1140	-1030	-910
35/65 R33 XLD D2 L5 Michelin	+10	-20	-440	-580	-510
35/65 R33 X-Mine D2 L5 Michelin	+20	-20	+260	-50	-40

Type of boom	Type of bucket	ISO/SAE Bucket volume	Material density (t/m ³)										
			L350F	0,8	1,0	1,2	1,4	1,6	1,8	2,0			
Standard boom	General purpose	8,4 m ³					9,2		8,4				
	Rock	STE 6,9 m ³								6,9		6,6	
		SPN 6,9 m ³								6,9		6,6	
		SPN 7,7 m ³						7,7		7,3			
Light mtrl	Light mtrl	12,7 m ³		12,7									
Long boom	General purpose	7,7 m ³					8,5		7,7				
	Rock	STE 6,9 m ³								6,9		6,6	
		SPN 6,5 m ³								6,5		6,2	
		SPN 6,9 m ³								6,9		6,6	
Light mtrl	Light mtrl	12,7 m ³		12,7									











How to read bucket fill factor

Bucket Selection Chart

The volume handled varies with the bucket fill and is often greater than indicated by the bucket's ISO/SAE volume. The table shows optimum bucket choice with regard to the material density.











Material	Bucket fill, %	Material density, t/m ³
Earth	110 - 115	1,4 - 1,6
Clay	110 - 120	1,4 - 1,6
Sand	100 - 110	1,6 - 1,9
Gravel	100 - 110	1,7 - 1,9
Rock	75 - 100	1,5 - 1,9

The size of rock buckets is optimized for optimal penetration and filling capability rather than the density of the material.

STANDARD BOOM		ROCK									GENERAL PURPOSE	LIGHT MATERIAL
Tires 875/65 R33 RL5K L5 GY Pin-on buckets												
		Teeth	Teeth & Segments	Bolt-on edges	Teeth	Teeth & Segments	Bolt-on edges	Teeth & Segments	Bolt-on edges	Bolt-on edges	Bolt-on edges	
Volume, heaped ISO/SAE	m ³	6,6	6,9	6,9	6,8	6,9	6,9	7,7	7,7	8,4	12,7	
Static tipping load, straight	kg	40 030	39 060	39 340	38 920	38 230	38 730	37 810	38 330	38 810	37 830	
at 35°	kg	35 710	34 780	35 060	34 640	33 950	34 460	33 550	34 070	34 550	33 560	
at full turn	kg	35 220	34 290	34 580	34 150	33 470	33 980	33 060	33 590	34 070	33 080	
Breakout force	kN	504,7	472,8	474,8	392,6	372,3	373,9	356,8	358,3	419,1	376,4	
A	mm	10 990	11 070	10 740	11 430	11 500	11 180	11 600	11 270	10 970	11 160	
E	mm	1620	1670	1390	2000	2050	1770	2130	1850	1590	1760	
H ^{*)}	mm	3790	3720	3940	3500	3430	3650	3370	3590	3790	3640	
L	mm	7460	7460	7460	7430	7430	7430	7550	7550	7280	7730	
M ^{*)}	mm	1830	1790	1590	2160	2120	1920	2180	1980	1740	1890	
N ^{*)}	mm	2730	2680	2530	2980	2920	2790	2960	2830	2640	2700	
V	mm	3970	3970	3970	3970	3 970	3970	3970	3970	3970	4500	
a, clearance circle	mm	18 090	18 100	17 960	18 310	18 320	18 170	18 370	18 210	18 060	18650	
Operating weight	kg	49 810	50 230	50 020	50 280	50 700	50 550	50 940	50 790	50 130	51 030	

*) Measured to the tip of the bucket teeth or bolt-on edge. Dump height to bucket edge. Measured at 45° dump angle. (Spade nose buckets at 42°.)

Note: This only applies to genuine Volvo attachments.

LONG BOOM		ROCK									GENERAL PURPOSE	LIGHT MATERIAL
Tires 875/65 R33 RL5K L5 GY Pin-on buckets												
		Teeth	Teeth & Segments	Bolt-on edges	Teeth	Teeth & Segments	Bolt-on edges	Teeth & Segments	Bolt-on edges	Bolt-on edges	Bolt-on edges	
Volume, heaped ISO/SAE	m ³	6,2	6,5	6,5	6,4	6,5	6,5	6,9	6,9	7,7	12,7	
Static tipping load, straight	kg	37 810	36 950	37 220	36 860	36 210	36 670	35 960	36 420	36 810	35 590	
at 35°	kg	33 620	32 800	33 070	32 700	32 050	32 520	31 810	32 280	32 660	31 450	
at full turn	kg	33 150	32 320	32 600	32 230	31 580	32 050	31 340	31 810	32 180	30 980	
Breakout force	kN	471,7	442,4	443,6	365,9	347,6	348,5	338,1	339,1	396,8	341,2	
A	mm	11 370	11 430	11 110	11 790	11 860	11 540	11 920	11 600	11 300	11 580	
E	mm	1640	1690	1400	2040	2080	1790	2140	1850	1570	1830	
H ^{*)}	mm	4290	4220	4440	4010	3940	4160	3900	4120	4310	4130	
L	mm	7870	7870	7870	7850	7840	7840	7900	7900	7650	8200	
M ^{*)}	mm	1800	1770	1560	2120	2090	1890	2130	1930	1690	1910	
N ^{*)}	mm	3060	3010	2850	3310	3250	3110	3280	3140	2950	3050	
V	mm	3970	3970	3970	3970	3970	3970	3970	3970	3970	4500	
a, clearance circle	mm	18 380	18 390	18 240	18600	18 610	18 450	18 640	18 480	18 330	18 960	
Operating weight	kg	51 320	51 740	51 530	51 790	52 210	52 060	52 330	52 180	51 580	52 660	

*) Measured to the tip of the bucket teeth or bolt-on edge. Dump height to bucket edge. Measured at 45° dump angle. (Spade nose buckets at 42°.)

Note: This only applies to genuine Volvo attachments.

STANDARD EQUIPMENT

Service and maintenance

Engine oil remote drain and fill
Transmission oil remote drain and fill
Grouped lubrication points, ground accessible
Pressure check connections: transmission and hydraulic, quick-connect, grouped on console for easy access
Tool box, lockable
Wheel nut wrench kit

Engine

Three stage air cleaner, pre-cleaner, primary and secondary filter
Indicator glass for coolant level
Preheating of induction air
Fuel pre-filter with water trap
Fuel filter
Crankcase breather oil trap

Electrical system

24 V, pre-wired for optional accessories
Alternator 24V/ 80A
Battery disconnect switch with removable key
Fuel gauge
Hour meter
Electric horn
Instrument cluster: <ul style="list-style-type: none"> • Fuel level • Transmission temperature • Coolant temperature • Instrument lighting
Reverse alarm
Lighting: <ul style="list-style-type: none"> • Twin halogen front headlights with high and low beams • Parking lights • Double brake and tail lights • Turn signals with flashing hazard light function • Halogen work lights (4 front and 4 rear)

Contronic monitoring system

Monitoring and logging of machine data
Contronic display
Fuel consumption
Ambient temperature
Clock
Brake test
Test function for warning and indicator lights
Warning and indicator lights: <ul style="list-style-type: none"> • Battery charging • Parking brake
Warning and display message: <ul style="list-style-type: none"> • Engine coolant temperature • Charge-air temperature • Engine oil temperature • Engine oil pressure • Transmission oil temperature • Transmission oil pressure • Hydraulic oil temperature • Brake pressure • Parking brake applied • Parking brake NOT applied • Brake charging • Overspeed at direction change • Axle oil temperature • Steering pressure • Crankcase pressure • Attachment lock open
Level warnings: <ul style="list-style-type: none"> • Fuel level • Engine oil level • Engine coolant level • Transmission oil level • Hydraulic oil level • Washer fluid level
Engine torque reduction in case of malfunction indication: <ul style="list-style-type: none"> • High engine coolant temperature • High engine oil temperature • Low engine oil pressure • High crankcase pressure • High charge-air temperature
Engine shutdown to idle in case of malfunction indication: <ul style="list-style-type: none"> • High transmission oil temperature • Slip in transmission clutches
Keypad, background lit
Start interlock when gear is engaged

Drivetrain

Automatic Power Shift (APS) with operator controlled transmission disengagement when braking and mode selector with AUTO mode
Fully automatic gear shifting, 1-4
Pulse Width Modulation (PWM) controlled gear shifting
Torque converter with Lock-Up
Automatic Lock-Up shifting, 3-4 (gear selector in 4) and 2 (gear selector in 2)
Forward and reverse switch by hydraulic lever console
Indicator glass for transmission oil level

Brake system

Wet oil circulation-cooled disc brakes on all four wheels
Dual brake circuits
Dual brake pedals
Secondary brake system
Parking brake, electric-hydraulic
Brake wear indicators

Cab

ROPS (ISO 3471), FOPS (ISO 3449)
Acoustic inner lining
Ashtray
Cigarette lighter, 24 V power outlet
Lockable door
Cab heating with fresh air inlet and defroster
Fresh air inlet with two filters
Automatic climate control (ACC)
Floor mat
Dual interior lights
Dual interior rear-view mirrors
Dual exterior rear-view mirrors
Sliding window, right side
Tinted safety glass
Operator's seat, KAB, air-suspended, heavy-duty
Lap-type retractable seatbelt (SAE J386)
Ergonomic heavy-duty operator's seat with adjustable position and suspension
Seat-mounted adjustable lever console, working hydraulics
Adjustable steering wheel
Storage compartment
Document pocket
Sun visor
Beverage holder
Windshield washer front and rear
Windshield wipers front and rear
Interval function for front and rear wipers
Service platforms with slip protected surfaces on front and rear fenders
Comfort Drive Control (CDC)

Hydraulic system

Main valve, double-acting 2-spool with electric pilots
Variable displacement axial piston pumps (3) for: <ul style="list-style-type: none"> • Steering system, working hydraulics • Working hydraulics, brakes • Cooling fan, brakes
Electric-hydraulic servo control
Electric level lock
Boom kick-out, automatic, adjustable from cab
Return-to-dig, automatic, adjustable from cab
Bucket positioner, automatic, adjustable from cab
Double-acting hydraulic cylinders with end-damping
Indicator glass for hydraulic oil level
Hydraulic oil cooler

External equipment

Fenders, front with rubber extensions
Viscous cab mounts
Rubber engine and transmission mounts
Lifting eyes
Easy-to-open side panels with gas struts
Frame, joint lock
Vandalism lock prepared for <ul style="list-style-type: none"> • Batteries • Engine compartment • Radiator
Tie-down eyes
Recovery eyes
Tow hitch

OPTIONAL EQUIPMENT

Service and maintenance

Tool kit
Automatic lubrication system
Automatic lubrication system for long boom
Refill pump for automatic lubrication system
Oil sampling valve

Engine

Air pre-cleaner, oil-bath type
Air pre-cleaner, cyclone type
Cooling package: Radiator and charge air cooler, corrosion-protected
Engine block heater, 230 V
Engine auto shutdown
ESW, increased engine protection
ESW, disabled engine protection
Hand throttle control
Fuel fill strainer
Fast fill fuel system
Fuel heater
Reversible cooling fan
Max. fan speed, hot climate

Electrical system

Alternator, 80 A with air filter
Alternator, 110 A
Battery, high capacity
Anti-theft device
Work lights front, high intensity discharge (HID)
Work lights front, on cab, dual
Work lights rear, on cab
Work lights rear, on cab, dual
Warning beacon, rotating

Cab

Radio with CD player
Radio installation kit incl. 11 A, 12 V outlet, left side
Radio installation kit incl. 11 A, 12 V outlet, right side
Rear-view camera incl. monitor, colour
Rear-view mirrors, electrically adjustable and heated
Asbestos dust protection filter
Carbon filter
Automatic climate control panel, with Fahrenheit scale
Lunchbox holder
Seatbelt, 3", (width 75 mm)
Steering wheel knob
Sun blind, rear window
Sun blind, side windows
Timer cab heating
Window sliding, door
Universal door/ignition key
Anchorage for Operator's manual

Drivetrain

Limited Slip differential, rear axle
Limited Slip differential, front and rear axle
Speed limiter, 20 km/h
Speed limiter, 30 km/h

Brake system

Oil coolers for front and rear axles

Hydraulic system

Boom suspension system with single-acting lift function
Arctic kit, pilot hoses, brake accumulators and hydraulic oil
3rd electro-hydraulic function
3rd electro-hydraulic function for long boom
Hydraulic oil cooler, corrosion-protected
Hydraulic attachment bracket
Separate attachment locking
Biodegradable hydraulic fluid
Fire-resistant hydraulic fluid
Hot climate hydraulic fluid

External equipment

Long boom

Protective equipment

Guards for front headlights
Guards for tail lights
Guards for tail lights, heavy-duty
Guards for rear work lights
Guards for radiator grill
Windows, side and rear guards
Windshield guard
Belly guard, front
Belly guard, rear
Mudguards fixed front and swing out rear, mudguards wideners incl.

Other equipment

Secondary steering with automatic test function
Logger version
Block handler kit
Block handler kit, heavy-duty
CE-marking
Sound decal, EU
CareTrack, GSM (Europe and North America)
CareTrack, GSM/Satellite (Europe and North America)

Tires and Rims

35/65 R33 (875/65 R33):
• L4
• L5
Rims, 33-28.00/3.5:
• Five piece
• Five piece, wood protected
• Five piece, heavy-duty

Attachments

Buckets (pin-on):
• Rock, straight edge
• Rock, spade nose
• Rock, side-dump, spade nose
• General purpose, straight edge
• Light material
Wear parts:
• Adapters for teeth, weld-on
• Teeth
• Segments, bolt-on
• Edge savers, bolt-on
Block handling equipment (hook-on):
• Rock bucket
• Stone fork
• Breaker tine
• Rake
Log grapples



Volvo Construction Equipment is different. Our machines are designed, built and supported in a different way. That difference comes from an engineering heritage of over 175 years. A heritage of thinking first about the people who actually use the machines. About how to help them be safer, more comfortable, more productive. About the environment we all share. The result of that thinking is a growing range of machines and a global support network dedicated to helping you do more. People around the world are proud to use Volvo. And we're proud of what makes Volvo different – **More care. Built in.**



Not all products are available in all markets. Under our policy of continuous improvement, we reserve the right to change specifications and design without prior notice. The illustrations do not necessarily show the standard version of the machine.

VOLVO

Volvo Construction Equipment
www.volvoce.com

Ref. No. VOE21E1002740
Printed in Sweden 2009.04-X,X
Volvo, Eskilstuna

English
WLO