

314C LCR

Hydraulic Excavator



Cat® 3064 T Diesel Engine

Gross Power 70 kW/95 hp

Net Power (ISO 9249) at 1950 rpm 67 kW/91 hp

Maximum Lifting Capacity 7800 kg

Tail Swing Radius 1480 mm

Operating Weight 15 120 kg

Equipped with 2600 mm blade, one-piece boom, 3000 mm stick, 600 mm shoes, and 0.41 m³ bucket.

314C LCR Hydraulic Excavator

The 314C LCR offers a compact radius and improved performance, versatility and styling.

Compact Radius

The 314C LCR features a compact radius, making it ideal for working in urban construction where space is often restricted. **pg. 4**

Engine

The new Cat 3064 T engine delivers outstanding performance, fuel efficiency and low sound levels. This compact engine was developed specifically for construction equipment and provides excellent durability. **pg. 5**

Operator Station

An enlarged cab and new window design enhance visibility and operator comfort. Sliding door system allows easy operator access, even in tight quarters. All operator controls are designed for smooth, low-effort operation and easy reach. **pg. 7**

Hydraulics

The open-center, two-pump hydraulic system provides high efficiency and reliability. The machine's pump flow control improves fuel efficiency, ensures smooth control, reduces sound levels and extends component life. **pg. 6**

Increased horsepower, better controllability, extended service intervals and a redesigned operator station increase your productivity and lower your operating costs.



Front Linkage

Front linkage variations allow the use of one boom, two sticks and five bucket sizes for maximum productivity on a wide range of jobs. **pg. 8**

Buckets, Quick Coupler and Work Tools

Ex-CWTS available buckets, quick couplers, multi-grapples, shears, and ex-CIPL available hammers – to provide a total solution package to the end-user. **pg. 9**

Undercarriage and Blades

Rugged Cat undercarriage design and proven structural manufacturing techniques ensure outstanding durability in the toughest conditions. Blades feature replaceable and reversible cutting edges for long service life and reliability. **pg. 10**

Serviceability

Longer service intervals and easier maintenance result in better machine availability and lower owning and operating costs. **pg. 11**

Complete Customer Support

Your Cat dealer offers a wide range of services that can be set up under a customer support agreement when you purchase your equipment. The dealer will help you choose a plan that can cover everything from machine configuration to eventual replacement.



Compact Radius

Compact radius design delivers top performance in tight quarters.



Dimensions

1 Front Swing From Center	
2500 mm stick	1970 mm
3000 mm stick	2220 mm
2 Rear Swing	
From Center	1480 mm
3 Overhang	
500 mm shoes	235 mm
600 mm shoes	185 mm
700 mm shoes	135 mm
4 Width	
2500 mm stick	3450 mm
3000 mm stick	3700 mm

Compact Radius Design. The 314C LCR features a compact radius, making it ideal for working in tight areas.

Shorter Tail Swing Radius. A shorter tail swing radius makes the 314C LCR easier to operate against walls and in other tight areas, reducing the risk of damage to the rear of the machine during operation.

Flexibility in Tight Quarters. The shorter tail measurement allows the excavator to work productively in urban construction, on logging roads and other space-restricted sites.

Engine

The four-cylinder turbocharged Cat 3064 T engine is built for power, reliability, economy and low emissions.

Torque Rise. The engine has a long-stroke piston movement for high torque at medium to low speeds – a feature that is especially beneficial for heavy-duty use.

Automatic Engine Control. Provides convenient one-touch command. Three-stage control maximizes fuel efficiency and reduces sound levels.

Low Fuel Consumption. The engine offers low fuel consumption, improved thermal efficiency and reduced resistance between pistons and liners.

Maintenance Access. The oil level gauge, oil filter, fuel filter and priming pump are all located in front of the engine for easy maintenance. The engine oil filter and fuel filter change intervals have been extended.

Crankshaft and Connecting Rods. The engine has a specially-balanced crankshaft to counteract typical four-cylinder engine vibration. The surface of the crankshaft journals and pins are induction-hardened to improve abrasion resistance.

Pistons and Rings. Heat-resistant aluminum alloy pistons have a short compression height, reducing weight and improving combustion efficiency. The piston ring set consists of three rings, treated for maximum wear resistance.



Cooling System. A large-diameter fan and full-length, water-cooled cylinders, combined with excellent thermal efficiency, help prevent overheating. The result is longer engine life and the ability to operate at high temperatures and under heavy loads. The core radiator is equipped with waved fins to prevent clogging.

Lubrication System. The system utilizes an external gear-type, high-efficiency oil pump. The large oil filter is composed of a main filter and a bypass filter, designed for high performance.

Sound. 3064 T engine complies with the EU sound regulation (2000/14/EC)

Hydraulics

Cat hydraulics deliver power and precise control to keep material moving at high volume.



High Efficiency Hydraulics. The 314C LCR uses an open-center, two-pump system. The main pumps are variable-displacement axial piston pumps and are driven directly from the engine. The pump drive is direct, so transmission efficiency remains high.

Component Layout. All major components are located close together, so shorter tubes and lines are used between components, resulting in less friction loss in the lines and reduced pressure drops.

Flow Control System. When controls are in neutral position, flow is minimized resulting in longer component life and lower fuel consumption and sound levels.

Hydraulic Cross-Sensing System. The system utilizes each of the main hydraulic pumps to 100 percent of engine power under all operating conditions, resulting in faster implement speeds and pivot turns.

Stick Regeneration Circuit. Saves energy while the stick is in use, providing shorter cycle times and lower operating costs.

Pilot System. Increased pilot hydraulic pressure provides better control to the front linkage, swing and travel operations.

Precise Control. Hydraulics deliver smooth changes in speed and outstanding overall control, so operators remain comfortable and productive throughout the day.

Boom Drift Reducing Valve. This valve reduces the natural drift of the boom, so lifted material will remain suspended for long periods with virtually no drift.

Auxiliary Hydraulic Valve. The auxiliary hydraulic valve is standard on the 314C LCR for use with optional hydraulic circuits.

Operator Station

Designed for simple, easy operation, the 314C LCR allows the operator to focus on production.



Sliding Door. The cab door slides alongside the cab and takes less space to open and close than a hinged door. This unique design allows the operator to easily get in and out of the cab when working against walls on job sites, even when attachments are added.

Cab Design. An enlarged cab with curved styling gives the operator a comfortable, spacious working environment and improved visibility.

Consoles. Redesigned consoles feature a simple, functional design. Both consoles have attached adjustable armrests and slide forward and backward.

Monitor. A compact monitor is located at the right console for excellent visibility from the operator's seat. The monitor displays instrument panel gauges and indicators in an easy-to-read format.

Cab Mounts. The cab shell is attached to the frame with viscous rubber cab mounts, that dampen vibrations and sound levels while enhancing operator comfort.



Travel Controls. The footrest provides a more comfortable way to control the travel pedals. The two travel control levers have a reverse-L shape, making them easier to operate. Lever stroke and force have been adjusted to improve fine control and to prevent jolting during travel.

Seat. The new suspended seat slide forward and backward independent of the consoles, so it can be adjusted to the operator's comfort level.

Hydraulic Activation Control Lever. For added safety, this lever must be in the locked position before the operator can leave the cab. This feature prevents the machine from operating without the operator in the cab.

Climate Control. The 314C LCR features a fully automatic climate control. The air conditioner is standard and adjusts temperature and flow.

Front Linkage

Designed for maximum flexibility to keep productivity and efficiency high on all jobs.



Front Linkage Attachments. Allows the use of one boom, two sticks and five buckets. Using these combinations makes the excavator productive in a wide range of applications.

Boom. The boom is designed to provide maximum digging capability. The Cat one-piece boom features a fabricated box-section design. Robotic welding and high-tensile strength steel on upper, lower and side plates provide high durability and consistency.

Sticks. Two stick attachments are available: a long stick to maximize reach or medium stick for the most versatile front linkage. Both sticks use a box-section design made of high tensile-strength steel and a buffer plate.

Linkage Bearings. A self-lubricated, sintered bearing greatly extends the greasing interval on front linkage pins by reducing pin friction. Greasing intervals on the bucket swing pin connection are also extended using a mesh bearing design.

Buckets. High tensile-strength steel is used in high-stress areas for excellent wear and shock resistance. The side plates are angled to prevent contact of the bucket sidewalls during trenching operations. All five bucket sizes are a general-purpose design and share a common side profile.

Bucket-Flop Adjustment Mechanism. All 300-family excavators are equipped with this feature, allowing the operator or service person to reduce the side play at the bucket to stick-nose connection. This attachment is only available when Cat buckets are ordered.

Work Tools

A wide variety of Work Tools help optimize machine performance. Purpose designed and built to Caterpillar's high durability standards.

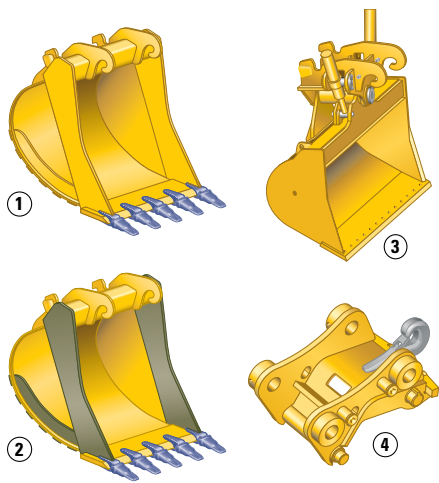

Work Tools. Caterpillar work tools are designed to function as an integral part of your excavator and to provide the best possible performance in your particular application. All work tools are performance-matched to Cat machines.

Quick Couplers. Quick Couplers enable the operator to simply release one work tool and connect to another, making your hydraulic excavator highly versatile. Productivity also increases, as a carrier no longer needs to be idle between jobs. Caterpillar offers hydraulic and spindle quick coupler versions.

Buckets. Caterpillar offers a wide range of specialized buckets, each designed and tested to function as an integral part of your excavator. Buckets feature the Caterpillar Ground Engaging Tools.

- 1 Excavation (X)
- 2 Extreme Excavation (EX)
- 3 Ditch Cleaning
- 4 Quick Coupler

Hammers. Cat hammer series deliver very high blow rates, increasing the productivity of your tool carriers in demolition and construction applications. Wide oil flow acceptance ranges make the Caterpillar hammers suitable for a wide range of carriers and provide a system solution from one safe source.

Orange Peel Grapples. The Orange Peel Grapple is constructed of high-strength, wear-resistant steel, with a low and compact design that makes it ideal for dump clearance. There are several choices of tine and shell versions.

Multi-Grapples. The Multi-Grapple with unlimited left and right rotation is the ideal tool for stripping, sorting, handling and loading. The powerful closing force of the grab shells combined with fast opening/closing time ensures rapid cycle time which translates to more tons per hour.

Vibratory Plate Compactors. Cat compactors are performance-matched to Cat machines, and integrate perfectly with the Cat hammer line – brackets and hydraulic kits are fully interchangeable between hammers and compactors.

Specifications for Pin-on Buckets

Contact your Caterpillar dealer for special bucket requirements.

		Excavation						Extreme Excavation		
A	Bite width	mm	600	750	900	1000	1100	1200	500	1200
B	Tip radius	mm	1230	1230	1230	1230	1230	1230	1140	1230
	Capacity	Liters	280	380	485	560	640	715	210	715
	Weight	kg	316	336	375	397	430	453	314	463

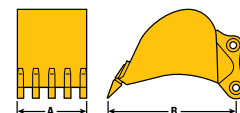

Undercarriage and Blades

Durable undercarriage absorbs stresses and provides excellent stability.



Blades. Three blade widths are available as attachments. The bolt-on cutting edge consists of three pieces, which can be reused by turning them upside down. Replaceable bolt-on edges protect the blade from damage and wear. Mesh bearings in the pin joints of the blade cylinder extend the greasing interval.

Carbody and Track Roller Frame. X-shaped, box-section carbody provides high rigidity and excellent resistance to torsional bending. The track frame is made from a press-formed pentagonal section for maximum strength and long service life. The carbody and track roller frame assembling process use robot welding to ensure continuous, high-quality welds.

Rollers and Idlers. Sealed and lubricated track rollers, carrier rollers and idlers provide excellent service life to keep the machine in the field longer.

Upper Frame. The rugged upper structure is designed for maximum durability and efficient use of materials.

Grease-Lubricated Track. Grease-lubricated seals protect the track link and provide longer wear life by helping to keep dirt and debris from entering the pin and bushing joint.

Roller Lubrication. All rollers, sprockets and idler joints are closed with floating seals. Lubricating oil from the seals prevents water and dirt from entering. The seals also make lubrication maintenance-free.

Travel Motors. Automatic speed selection enables the machine to automatically shift up and down from high and low speeds in a smooth, controlled manner. An “anti-hunt” feature eliminates the hunting often associated with auto shifting when operating near the shift point.

Idler Guard. An idler guard is integral to the track roller frame. This standard guard helps maintain track alignment while traveling or working on slopes.

Segment-Type Rubber Track. Optional segment-type rubber track prevents damage to concrete and other road surfaces, especially in urban areas.

Serviceability

Simplified service and maintenance save you time and money.

Extended Service Intervals. Extended service and maintenance intervals reduce service time and machine availability. Use of oil-free bearings extends front linkage greasing interval to 1000 hours, except in bucket area.

Ground-Level Maintenance. For operator convenience, most daily maintenance areas can be easily reached from ground level.

Fan Guard. Engine radiator fan is completely enclosed by fine wire mesh, reducing the risk of injury.

DT Electrical Connectors. Connectors are water- and vibration-resistant, improving electrical system reliability.

Radiator and Oil cooler. Opening the engine hood allows easy access to the engine radiator and the oil cooler. A reserve tank and drain cock are attached to the radiator to simplify maintenance.

Air Filter. Cat radial seal provides superior cleaning efficiency.

Engine Inspection. The engine can be accessed from the upper structure or from under the machine. A steel wall separates the engine and pump compartments, preventing hydraulic oil from spraying on the engine in the event of a hydraulic line failure.

Engine Maintenance. To make daily servicing easier, the oil level gauge, oil filter, fuel filter and priming pump are grouped in front of the engine.

Fuel Tank. A drain cock is installed at the bottom of the tank, making it easier to remove water and sediment during maintenance.

Fuel-Water Separator. The water separator has a primary fuel filter element and is located in the radiator compartment for easy access from the ground.

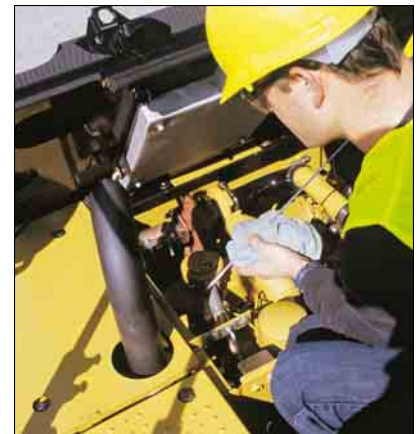

Engine

Cat 3064 T turbocharged diesel engine

	kW	hp
Gross power	70	95
Net power		
ISO 9249	67	91
EEC 80/1269	67	91

Dimensions

Bore	102 mm
Stroke	130 mm
Displacement	4.25 liters

- all engine horsepower (hp) are metric including front page.
- net power advertised is the power available at the flywheel when the engine is equipped with fan, air cleaner, muffler, and alternator
- no engine derating required below 1500 m altitude
- Meets Stage II EU Emission Directive 97/68/EC.

Drive

Travel speed	5.5 km/h
Maximum drawbar pull	110 kN

Operating Weights

Equipped with one-piece boom, long undercarriage and 0.41 m³ bucket capacity.

Stick length	2500 mm	3000 mm
Standard	kg	kg
500 mm triple grouser	13 800	13 800
2500 mm blade: add	810	810
Optional		
600 mm triple grouser	14 000	14 100
2600 mm blade: add	820	820
700 mm triple grouser	14 300	14 400
2700 mm blade: add	830	830

Hydraulic System

Main Implement System	
Maximum Flow (2x)	127 l/min
Maximum pressure	
Implements	299 bar
Travel	343 bar
Swing	230 bar
Pilot System	
Maximum flow	26.9 l/min
Maximum pressure	41 bar
Blade System	
Maximum flow	58.5 l/min
Maximum pressure	206 bar
Boom Cylinder	
Bore	110 mm
Stroke	1000 mm
Stick Cylinder	
Bore	120 mm
Stroke	1197 mm
Bucket Cylinder	
Bore	100 mm
Stroke	939 mm

Swing Mechanism

Swing Torque	30.90 kNm
Swing Speed	12.6 rpm

Service Refill Capacities

	Liters
Fuel Tank	200
Cooling System	17.5
Engine Oil	17.5
Swing Drive	3
Final Drive (each)	2.5
Hydraulic system (including tank)	150
Hydraulic tank	115

Sound

Operator Sound

The operator sound level measured according to the procedures specified in ISO 6396 is 74 dB(A), for cab offered by Caterpillar, when properly installed and maintained and tested with the doors and windows closed.

Exterior Sound

The labeled spectator sound power level measured according to the test procedures and conditions specified in 2000/14/EC is 100 dB(A).

Undercarriage

Caterpillar designed and built track-type undercarriage.

	Ground Pressure
Standard	
500 mm triple grouser	0.41 bar
Optional	
600 mm triple grouser	0.35 bar
700 mm triple grouser	0.30 bar

Dimensions

All dimensions are approximate.

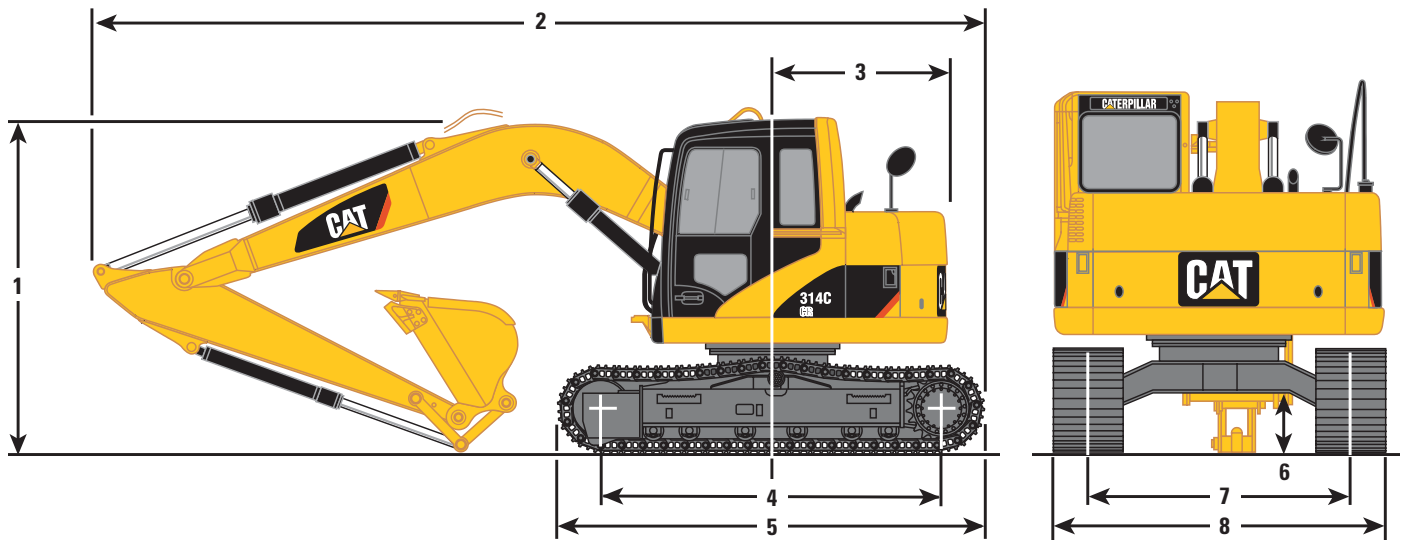

	mm	mm		mm	mm
Stick Length	2500	3000	6 Ground clearance	455	455
1 Shipping height	2820	2820	7 Track gauge	1990	1990
2 Shipping length	7410	7410	8 Transport width		
3 Tail swing radius	1480	1480	500 mm shoe	2490	2490
4 Length to centers of rollers	3040	3040	600 mm shoes	2590	2590
5 Track length	3750	3750	700 mm shoes	2690	2690

Working Ranges with One-Piece Boom (4650 mm)

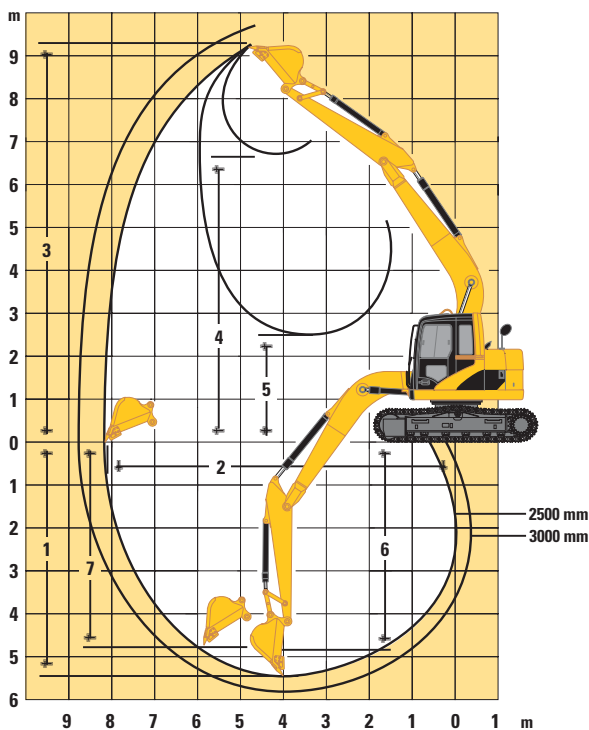













Stick Length	mm	*2500	**3000
1 Maximum Digging Depth	mm	5450	5950
2 Maximum Reach at Ground Level	mm	8180	8630
3 Maximum Cutting Height	mm	9300	9620
4 Maximum Loading Height	mm	6860	7190
5 Minimum Loading Height	mm	2500	2060
6 Maximum Depth Cat for 2440 Level Bottom	mm	5240	5770
7 Maximum Vertical Wall Digging Depth	mm	4910	5330
Minimum Front Swing Radius	mm	1970	2220
Stick Digging Force (SAE)	kN	64	57
Bucket Digging Force (SAE)	kN	94	94

* With 0.52 m³ bucket
 ** With 0.41 m³ bucket













Lift capacities with One-Piece Boom (4650 mm)

All weights are in kg













Medium stick – 2500 mm
Shoes – 600 mm
Bucket capacity – 0.52 m³
Bucket weight – 386 kg
Blade up

	1.5 m		3.0 m		4.5 m		6.0 m		7.5 m					
												m		
7.5 m												*1550	*1550	5.2
6.0 m					*3250	*3250						*1300	*1300	6.7
4.5 m					*3550	3450						*1250	*1250	7.6
3.0 m			*5950	*5950	*4200	3250	3300	2000				*1250	*1200	8.0
1.5 m			*7800	5550	*4900	3000	3200	1900				*1350	1150	8.0
0 m			*6600	5200	4900	2800	3100	1800				*1500	1200	8.0
-1.5 m	*4400	*4400	*7300	5100	4800	2700	3050	1750				*1850	1400	7.0
-3.0 m	*7800	*7800	*5600	5250	*3900	2750						*1750	*1750	6.0













Medium stick – 2500 mm
Shoes – 600 mm
Bucket capacity – 0.52 m³
Bucket weight – 386 kg
Blade down

	1.5 m		3.0 m		4.5 m		6.0 m		7.5 m					
												m		
7.5 m												*1550	*1550	5.2
6.0 m					*3250	*3250						*1300	*1300	6.7
4.5 m					*3550	*3550	*3150	2450				*1250	*1250	7.6
3.0 m			*5950	*5950	*4200	3800	*3400	2350				*1250	*1250	8.0
1.5 m			*7800	6750	*4900	3550	*3650	2250				*1350	*1350	8.0
0 m			*6600	6350	*5200	3350	*3450	2150				*1500	1450	7.7
-1.5 m	*4400	*4400	*7300	6300	4950	3300	*3450	2100				*1850	1700	7.0
-3.0 m	*7800	*7800	*5600	*5600	*3900	3300						*1750	*1750	5.8

Long stick – 3000 mm
Shoes – 600 mm
Bucket capacity – 0.41 m³
Bucket weight – 344 kg
Blade up

	1.5 m		3.0 m		4.5 m		6.0 m		7.5 m					
												m		
7.5 m					*1800	*1800						*1350	*1350	5.9
6.0 m					*2850	*2850	*2300	2150				*1200	*1200	7.3
4.5 m					*3150	*3150	*2900	2100				*1150	*1150	8.0
3.0 m			*4950	*4950	*3800	3300	*3150	2000	*1800	1300		*1150	1050	8.4
1.5 m			*7250	5750	*4600	3000	3200	1900	*2200	1250		*1250	1000	8.5
0 m			*7550	5200	4950	2800	3100	1800	2150	1200		*1400	1050	8.2
-1.5 m	*4000	*4000	*7700	5050	4800	2700	*3050	1700				*1700	12500	7.5
-3.0 m	*6700	*6700	*6350	5100	*4300	3650	*2800	1750				*1950	1600	6.4
-4.5 m			*3750	*3750	*2300	*2300						*2000	*2000	4.8

Long stick – 3000 mm
Shoes – 600 mm
Bucket capacity – 0.41 m³
Bucket weight – 344 kg
Blade down

	1.5 m		3.0 m		4.5 m		6.0 m		7.5 m					
												m		
7.5 m					*1800	*1800						*1350	*1350	5.9
6.0 m					*2850	*2850	*2300	*2300				*1200	*1200	7.3
4.5 m					*3150	*3150	*2900	2500				*1150	*1150	8.0
3.0 m			*4950	*4950	*3800	*3800	*3150	2400	*1800	1600		*1150	*1150	8.4
1.5 m			*7250	6950	*4600	3600	*3500	2250	*2450	1550		*1250	*1250	8.5
0 m			*7550	6400	*5100	3350	*3700	2150	2150	1500		*1400	1300	8.2
-1.5 m	*4000	*4000	*7700	6200	*5050	3250	*3550	2100				*1700	1500	7.5
-3.0 m	*6700	*6700	*6350	6250	*4300	3250	*2800	2100				*1950	*1950	6.4
-4.5 m			*3750	*3750	*2300	*2300						*2000	*2000	4.8

Standard Equipment

Standard and optional equipment may vary. Consult your Caterpillar dealer for specifics.

Electrical

50 Ampere alternator
Working light, chassis mounted
Horn
Cat batteries

Operator Environment

Bolt-on FOGS capability
Openable laminated front windshield with assist device
Tempered other windows
Front windshield guard bosses
Openable polycarbonate skylight with sunshade
Pillar mounted windshield wiper and washer
Rear window emergency exit
Seat height adjustable, with armrest and retractable seatbelt without head rest
Integrated seat, console and joystick type controls
Instrument panel and gauges, warning information and machine condition
Positive filtered ventilation
Air conditioner (auto) with defroster

Interior lighting
Coat hook
Ashtray
Literature holder
Utility space for magazines
Beverage holder
Neutral lever for all controls
Travel control pedals with removable hand levers
Washable floor mat
Radio mounting
Power supply 12V-5A (cigar lighter)

Power Train

Cat 3064T Diesel engine with 24-volt electric starting
Automatic engine speed control and one touch low idle
Water separator in fuel line
Two speed auto-shift travel
Straight line travel

Undercarriage

Hydraulic track adjusters
Track type undercarriage with grease lubricated seals
Idler track guiding guard
Idler and center section track guiding guards-314C LCR
500 mm Triple Grouser shoes

Other Standard Equipment

Auxiliary hydraulic valve
Door locks and cap locks and Caterpillar one key security system
Mirrors (Frame-right, rear)
Automatic swing parking brake
EU configuration meets EU stage 2 sound and emission regulations

Optional Equipment

Air conditioner
Alarm Travel
Auxiliary hydraulic lines for sticks and boom
Blades
2500 mm, for use with 500 mm steel or segment rubber track
2600 mm, for use with 600 mm track
2700 mm, for use with 700 mm track
Bucket linkage
Cab mounted working lights
Cold weather start
Cooling EU high ambient,
Coolant ext. Life (50°C)

CWTS buckets
Guard, swivel
Guard bottom HD
Guard falling objects
Guard Cab top
Hydraulic arrangements, auxiliary: single-function capability
combined single and double function capability
Medium pressure hydraulic arrangement

Right-side boom lights
Step extension
Stick lowering check valve
Sticks
3000 mm stick
2500 mm stick
Tracks
500 mm segment rubber track
600 mm triple grouser
700 mm triple grouser

314C LCR Hydraulic Excavator

For more complete information on Cat products, dealer services, and industry solutions, visit us on the web at www.cat.com

Materials and specifications are subject to change without notice. Featured machines in photos may include additional equipment. See your Caterpillar dealer for available options.

© 2007 Caterpillar -- All rights reserved

CAT, CATERPILLAR, their respective logos, "Caterpillar Yellow" and the POWER EDGE trade dress as well as corporate and product identity used herein, are trademarks of Caterpillar and may not be used without permission.

HEHH3068-2 (02/2007) hr

CATERPILLAR[®]