

VOLVO EXCAVATOR

EC460B LC



- **Engine power, gross:**
245 kW (329 hp)
- **Operating weight:**
45,1 ~ 47,9 t
- **Buckets (SAE):**
1 800 ~ 3 775 l
- Turbocharged VOLVO diesel engine with direct injection and charged air cooler meets EU Stage IIIA requirements
- Contronics, Volvo's advanced mode selection system and electronically controlled system
- 2 variable displacement axial piston pumps. Independent and simultaneous movements of the digging equipment are controlled by "Automatic Sensing Work Mode".
- Cab
 - Ergonomic environment for easier operator use
 - Low sound level
 - Filtered air
 - Hydraulic dampening mounts
- Strong digging equipment, produced by robotic welding
- High lifting, breakout and tearout forces for tough digging conditions
- Long undercarriage for excellent stability
- Auxiliary hydraulic valve is standard
- Prepared for a number of optional items

VOLVO



ENGINE

The next-generation Volvo diesel engine uses Volvo Advanced Combustion Technology (V-ACT) to deliver lower emissions and maintain superior performance and fuel efficiency. The Stage IIIA compliant engine uses precise, high-pressure fuel injectors, internal recirculation of engine exhaust and electronic engine controls to optimize machine performance.

Air Filter: 3-stage, and pre-cleaner

Automatic Idling System: Reduces engine speed to idle when the levers and pedals are not activated resulting in less fuel consumption and low cab noise levels.

Low-Emission Engine:

Make	VOLVO
Model	D12D EAE3
Power output at	30 r/s (1 800 rpm)
Net (ISO 9249/ DIN 6271)	235 kW (320 ps / 316 hp)
Gross (SAE J1995)	245 kW (333 ps / 329 hp)
Max. torque	1 720 N·m at 1 350 rpm
No. of cylinders	6
Displacement	12,1 l
Bore	131 mm
Stroke	150 mm



ELECTRICAL SYSTEM

High capacity electrical system that is well-protected. Waterproof double-lock harness plugs are used to secure corrosion free connections. The main relays and solenoid valves are shielded to prevent damage. The master switch is standard.

Contronics, provides advanced monitoring of machine functions and important diagnostic information.

Voltage	24 V
Batteries	2 x 12 V
Battery capacity	200 Ah
Alternator	28 V / 80 A



SERVICE REFILL CAPACITIES

Fuel tank	685 l
Hydraulic system, total	525 l
Hydraulic tank	270 l
Engine oil	42 l
Engine coolant	60 l
Slew reduction unit	2 x 6,0 l
Travel reduction unit	2 x 5,5 l



SLEW SYSTEM

The slew system uses 2 axial piston motors, driving 2 planetary gearboxes for maximum torque. Automatic slew holding brake and anti-rebound valves are standard.

Max. slew speed 8,5 rpm



DRIVE

Each track is powered by an automatic two-speed shift travel motor. The track brakes are multi-disc, spring-applied and hydraulic released. The travel motor, brake and planetary gears are well protected within the track frame.

Max. tractive effort 324,6 kN
 Max. travel speed 2,9 / 4,8 km/h
 Gradeability 35° (70%)



UNDERCARRIAGE

The undercarriage has a robust X-shaped frame, greased and sealed track chains are standard.

Fixed undercarriage (Std.):

No. of track shoes	2 x 52
Link pitch	216 mm
Shoe width, triple grouser	600 / 700 / 800 / 900 mm
Shoe width, double grouser	600 mm
No. of bottom rollers	2 x 9
No. of top rollers	2 x 2

Mechanically retractable undercarriage (Opt.):

No. of track shoes	2 x 52
Link pitch	216 mm
Shoe width, triple grouser	600 / 700 / 800 / 900 mm
Shoe width, double grouser	600 mm
No. of bottom rollers	2 x 9
No. of top rollers	2 x 3



HYDRAULIC SYSTEM

The hydraulic system, also known as the "Automatic Sensing Work Mode", is designed for high-productivity, high-digging capacity, high-maneuvering precision and good fuel economy. The summation system, boom, arm and slew priority along with boom and arm regeneration provide optimum performance.

The following important functions are included in the system:

Summation system: Combines the flow of both hydraulic pumps to ensure quick cycle times and high productivity.

Boom priority: Gives priority to the boom operation for faster raising when loading or performing deep excavations.

Arm priority: Gives priority to the arm operation for faster cycle times in leveling and for increased bucket filling when digging.

Slew priority: Gives priority to slew functions for faster simultaneous operations.

Regeneration system: Prevents cavitation and provides flow to other movements during simultaneous operations for maximum productivity.

Power boost: All digging and lifting forces are increased.

Holding valves: Boom and arm holding valves prevent the digging equipment from creeping.

Power Max: All function speeds are increased.

Main pump:

Type 2 x variable displacement axial piston pumps
Maximum flow ... 2 x 345 l/min

Pilot pump:

Type Gear pump
Maximum flow ... 1 x 31 l/min

Hydraulic motors:

Travel Variable displacement axial piston motor
with mechanical brake
Slew Fixed displacement axial piston motor with
mechanical brake

Relief valve setting:

Implement 31,4 / 34,3 Mpa
Travel circuit 31,4 Mpa
Slew circuit 24,5 Mpa
Pilot circuit 3,9 Mpa

Hydraulic cylinders:

Boom 2
Bore x Stroke \varnothing 165 x 1 590 mm
Arm 1
Bore x Stroke \varnothing 190 x 1 850 mm
Bucket 1
Bore x Stroke \varnothing 165 x 1 335 mm
ME bucket 1
Bore x Stroke \varnothing 175 x 1 335 mm



CAB

The operator's cab has easy access via a wide door opening. The cab is supported on hydraulic dampening mounts to reduce shock and vibration levels. These along with sound absorbing lining provide low noise levels. The cab has excellent all-round visibility. The front windshield can easily slide up into the ceiling and the lower front glass can be removed and stored in the side door.

Integrated air conditioning and heating system:

The pressurized and filtered cab air is supplied by an automatically controlled fan. The air is distributed throughout the cab from 13 vents.

Ergonomic operator's seat: The adjustable seat and joystick console move independently to accommodate the operator.

The seat has nine different adjustments plus a seat belt to for the operator's comfort and safety.

Sound Level:

Sound level in cab
according to ISO 6396 LpA 73 dB(A)
External sound level
according to ISO 6395
and EU Directive 2000/14/EC LwA 106 dB(A)



GROUND PRESSURE

- **Machine with fixed undercarriage** 7,0 m boom, 3,35 m arm, 2 060 l (1 730 kg) bucket and 9 300 kg counterweight.

Description	Shoe width	Operating weight	Ground pressure	Overall width
Triple grouser	600 mm	45 100 kg	78,4 kPa	3 340 mm
	700 mm	45 600 kg	67,7 kPa	3 440 mm
	800 mm	46 100 kg	59,8 kPa	3 540 mm
	900 mm	46 620 kg	53,9 kPa	3 640 mm
Double grouser	600 mm	44 850 kg	78,4 kPa	3 340 mm

- **Machine with retractable undercarriage** 7,0 m boom, 3,35 m arm, 2 060 l (1 730 kg) bucket and 9 300 kg counterweight.

Description	Shoe width	Operating weight	Ground pressure	Overall width
Triple grouser	600 mm	46 300 kg	80,4 kPa	3 340 mm
	700 mm	46 820 kg	69,6 kPa	3 440 mm
	800 mm	47 340 kg	61,8 kPa	3 540 mm
	900 mm	47 880 kg	55,9 kPa	3 640 mm
Double grouser	600 mm	46 050 kg	80,4 kPa	3 340 mm

MAX. PERMITTED BUCKETS

Note: 1. Bucket size based on ISO 7451, heaped material with a 1:1 angle of repose.
2. "Max permitted sizes" are for reference only and are not necessarily available from the factory.

- Max. permitted sizes for direct fit buckets:

Fixed undercarriage, counterweight 9 300 kg

Description	Unit	6,5 m ME boom	7,0 m Boom			
		2,55 m Arm	2,55 m Arm	3,35 m Arm	3,9 m Arm	4,8 m Arm
GP bucket 1,5 t/m ³	l	3 725	3 425	3 125	2 850	2 525
GP bucket 1,8 t/m ³	l	3 275	3 000	2 725	2 500	2 225
HD bucket 1,8 t/m ³	l	3 000	2 775	2 525	2 300	2 050
HD bucket 2,0 t/m ³	l	2 800	2 575	2 325	2 150	1 900

- Max. permitted sizes for quick fit buckets:

Fixed undercarriage, counterweight 9 300 kg

Description	Unit	6,5 m ME boom	7,0 m Boom			
		2,55 m Arm	2,55 m Arm	3,35 m Arm	3,9 m Arm	4,8 m Arm
GP bucket 1,5 t/m ³	l	3 600	3 300	2 975	2 725	2 400
GP bucket 1,8 t/m ³	l	3 150	2 875	2 600	2 375	2 100
HD bucket 1,8 t/m ³	l	2 900	2 650	2 400	2 200	1 950
HD bucket 2,0 t/m ³	l	2 700	2 475	2 225	2 050	1 800

- Max. permitted sizes for direct fit buckets:

Mechanically retractable undercarriage, counterweight 9 300 kg

Description	Unit	6,5 m ME boom	7,0 m Boom			
		2,55 m Arm	2,55 m Arm	3,35 m Arm	3,9 m Arm	4,8 m Arm
GP bucket 1,5 t/m ³	l	3 775	3 475	3 175	2 900	2 575
GP bucket 1,8 t/m ³	l	3 300	3 050	2 775	2 550	2 250
HD bucket 1,8 t/m ³	l	3 050	2 800	2 550	2 350	2 075
HD bucket 2,0 t/m ³	l	2 825	2 600	2 375	2 175	1 925

- Max. permitted sizes for quick fit buckets:

Mechanically retractable undercarriage, counterweight 9 300 kg

Description	Unit	6,5 m ME boom	7,0 m Boom			
		2,55 m Arm	2,55 m Arm	3,35 m Arm	3,9 m Arm	4,8 m Arm
GP bucket 1,5 t/m ³	l	3 650	3 350	3 025	2 775	2 450
GP bucket 1,8 t/m ³	l	3 200	2 925	2 650	2 425	2 150
HD bucket 1,8 t/m ³	l	2 950	2 700	2 450	2 250	1 975
HD bucket 2,0 t/m ³	l	2 725	2 500	2 275	2 075	1 825

DIMENSIONS

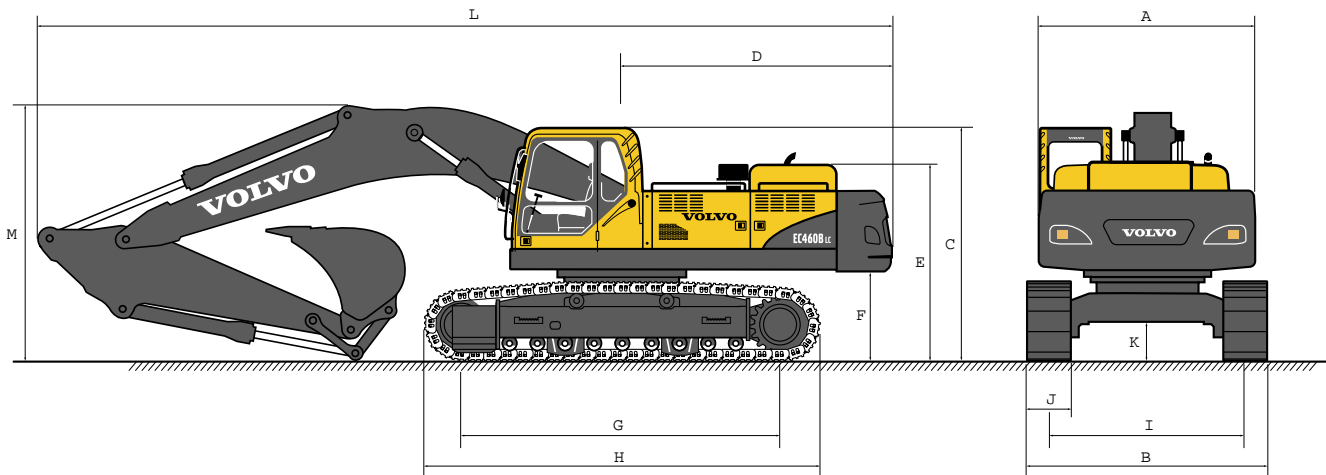

• Machine with fixed undercarriage

Description	Unit	6,5 m ME boom	7,0 m Boom			
		2,55 m Arm	2,55 m Arm	3,35 m Arm	3,9 m Arm	4,8 m Arm
A. Overall width of superstructure	mm	2 990	2 990	2 990	2 990	2 990
B. Overall width	mm	3 340	3 340	3 340	3 340	3 340
C. Overall height of cab	mm	3 250	3 250	3 250	3 250	3 250
D. Tail slew radius	mm	3 730	3 730	3 730	3 730	3 730
E. Overall height of engine hood	mm	2 750	2 750	2 750	2 750	2 750
F. Counterweight clearance *	mm	1 275	1 275	1 275	1 275	1 275
G. Tumbler length	mm	4 370	4 370	4 370	4 370	4 370
H. Track length	mm	5 370	5 370	5 370	5 370	5 370
I. Track gauge	mm	2 740	2 740	2 740	2 740	2 740
J. Shoe width	mm	600	600	600	600	600
K. Min. ground clearance *	mm	550	550	550	550	550
L. Overall length	mm	11 560	12 060	12 070	12 070	11 940
M. Overall height of boom	mm	3 770	3 630	3 650	3 690	4 650

• Machine with mechanically retractable undercarriage

Description	Unit	6,5 m ME boom	7,0 m Boom			
		2,55 m Arm	2,55 m Arm	3,35 m Arm	3,9 m Arm	4,8 m Arm
A. Overall width of superstructure	mm	2 990	2 990	2 990	2 990	2 990
B. Overall width (extended)	mm	3 490	3 490	3 490	3 490	3 490
Overall width (retracted)	mm	2 990	2 990	2 990	2 990	2 990
C. Overall height of cab	mm	3 360	3 360	3 360	3 360	3 360
D. Tail slew radius	mm	3 730	3 730	3 730	3 730	3 730
E. Overall height of engine hood	mm	2 860	2 860	2 860	2 860	2 860
F. Counterweight clearance *	mm	1 385	1 385	1 385	1 385	1 385
G. Tumbler length	mm	4 370	4 370	4 370	4 370	4 370
H. Track length	mm	5 370	5 370	5 370	5 370	5 370
I. Track gauge (extended)	mm	2 890	2 890	2 890	2 890	2 890
Track gauge (retracted)	mm	2 390	2 390	2 390	2 390	2 390
J. Shoe width	mm	600	600	600	600	600
K. Min. ground clearance *	mm	746	746	746	746	746
L. Overall length	mm	11 540	12 060	12 070	12 070	11 940
M. Overall height of boom	mm	3 800	3 770	3 790	3 830	4 790

* Without shoe grouser

DIMENSIONS

• Boom

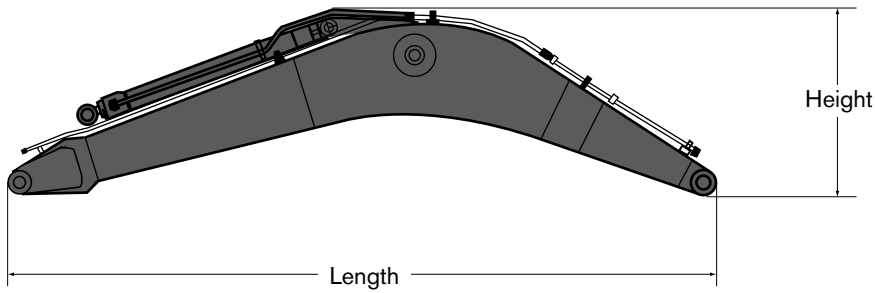

Description	6,5 m ME	7,0 m
Length	6 750 mm	7 250 mm
Height	2 000 mm	1 840 mm
Width	960 mm	960 mm
Weight	3 950 kg	4 000 kg

* Includes cylinder, pin and piping

• Arm

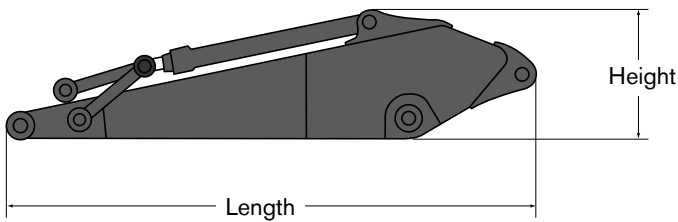

Description	2,55 m	3,35 m	3,9 m	4,8 m
Length	3 770 mm	4 590 mm	5 140 mm	6 100 mm
Height	1 235 mm	1 230 mm	1 240 mm	1 250 mm
Width	600 mm	600 mm	600 mm	600 mm
Weight	2 350 kg	2 500 kg	2 500 kg	2 700 kg

* Includes cylinder, piping and linkage

WORKING RANGES & DIGGING FORCES

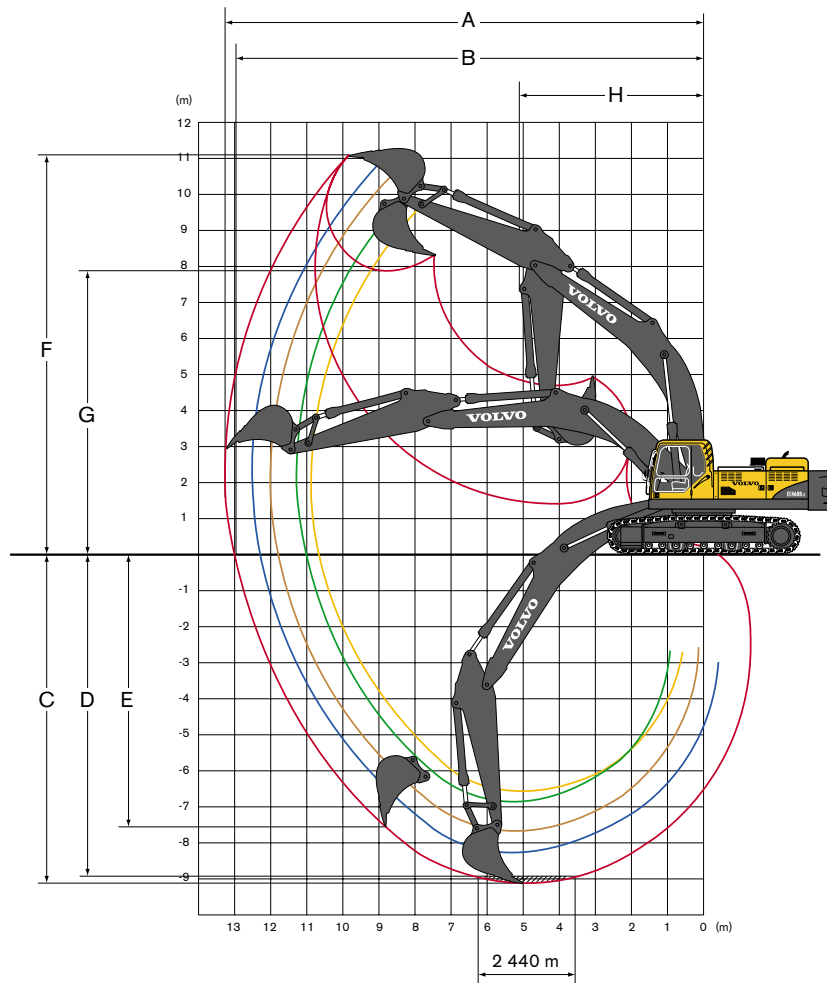

• Machine with direct fit GP bucket: fixed undercarriage

Description	Unit	6,5 m ME boom	7,0 m Boom			
		2,55 m Arm	2,55 m Arm	3,35 m Arm	3,9 m Arm	4,8 m Arm
A. Max. digging reach	mm	10 900	11 310	12 000	12 500	13 220
B. Max. digging reach on ground	mm	10 660	11 070	11 780	12 290	13 020
C. Max. digging depth	mm	6 570	6 900	7 700	8 250	9 150
D. Max. digging depth (2,44 m level)	mm	6 400	6 720	7 550	8 120	9 030
E. Max. vertical wall digging depth	mm	5 800	6 150	6 840	7 300	7 730
F. Max. cutting height	mm	10 580	10 820	10 970	11 150	11 090
G. Max. dumping height	mm	6 980	7 440	7 650	7 840	7 870
H. Min. front slew radius	mm	4 770	5 170	5 090	4 990	5 040

• Digging forces with direct fit bucket

Description	Unit	6,5 m ME boom	7,0 m Boom			
		2,55 m Arm	2,55 m Arm	3,35 m Arm	3,9 m Arm	4,8 m Arm
Bucket radius	mm	1 923	1 810	1 810	1 810	1 810
Breakout force – bucket (Normal / Power boost)	SAE kN	245,2 / 267,7	222,6 / 244,2	222,6 / 244,2	222,6 / 244,2	222,6 / 244,2
Breakout force – bucket (Normal / Power boost)	ISO kN	276,5 / 302,0	253,0 / 276,5	253,0 / 276,5	253,0 / 276,5	253,0 / 276,5
Tearout force – arm (Normal / Power boost)	SAE kN	217,7 / 237,3	224,6 / 245,2	190,2 / 208,9	170,6 / 186,3	154,9 / 169,6
Tearout force – arm (Normal / Power boost)	ISO kN	224,6 / 246,1	231,4 / 253,0	195,1 / 213,8	173,6 / 190,2	157,9 / 172,6
Rotation angle, bucket	deg	169	183	183	183	183

WORKING RANGES & DIGGING FORCES

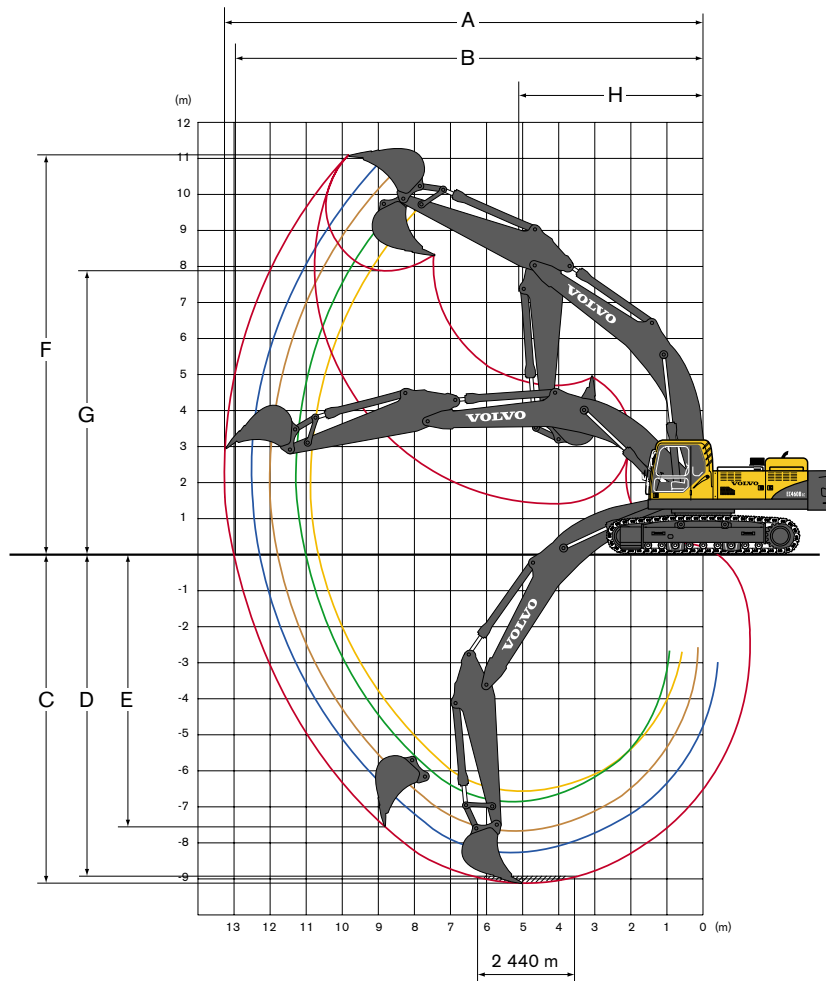

• Machine with direct fit GP bucket: mechanically retractable undercarriage

Description	Unit	6,5 m ME boom		7,0 m Boom		
		2,55 m Arm	2,55 m Arm	3,35 m Arm	3,9 m Arm	4,8 m Arm
A. Max. digging reach	mm	10 900	11 310	12 000	12 500	13 220
B. Max. digging reach on ground	mm	10 630	11 050	11 750	12 260	12 990
C. Max. digging depth	mm	6 440	6 770	7 570	8 120	9 020
D. Max. digging depth (2,44 m level)	mm	6 270	6 590	7 420	7 980	8 900
E. Max. vertical wall digging depth	mm	5 670	6 020	6 710	7 170	7 600
F. Max. cutting height	mm	10 710	10 950	11 110	11 280	11 220
G. Max. dumping height	mm	7 110	7 570	7 780	7 970	8 000
H. Min. front slew radius	mm	4 770	5 170	5 090	4 990	5 040















• Digging forces with direct fit bucket

Description	Unit	6,5 m ME boom		7,0 m Boom			
		2,55 m Arm	2,55 m Arm	3,35 m Arm	3,9 m Arm	4,8 m Arm	
Bucket radius	mm	1 923	1 810	1 810	1 810	1 810	
Breakout force – bucket (Normal / Power boost)	SAE	kN	245,2 / 267,7	222,6 / 244,2	222,6 / 244,2	222,6 / 244,2	222,6 / 244,2
Breakout force – bucket (Normal / Power boost)	ISO	kN	276,5 / 302,0	253,0 / 276,5	253,0 / 276,5	253,0 / 276,5	253,0 / 276,5
Tearout force – arm (Normal / Power boost)	SAE	kN	217,7 / 237,3	224,6 / 245,2	190,2 / 208,9	170,6 / 186,3	154,9 / 169,6
Tearout force – arm (Normal / Power boost)	ISO	kN	224,6 / 246,1	231,4 / 253,0	195,1 / 213,8	173,6 / 190,2	157,9 / 172,6
Rotation angle, bucket	deg		169	183	183	183	183

LIFTING CAPACITY (At the arm and without bucket)

Note: For lifting capacity including bucket, simply subtract actual weight of the direct fit bucket or the bucket with quick fit from the following values.

EC460B LC with fixed undercarriage















 Across undercarriage  Along undercarriage	Lifting hook related to ground level	3,0 m		4,5 m		6,0 m		7,5 m		9,0 m		Max. reach			
															Max. mm
with 600 mm shoe 9 300 kg CWT ME boom 6,5 m + arm 2,55 m	6,0 m	kg					*12 860	*12 860	*11 840	10 250			*11 050	8 940	8 140
	4,5 m	kg			*19 240	*19 240	*14 670	13 930	*12 580	9 990			*11 060	7 950	8 680
	3,0 m	kg			*22 060	20 050	*16 720	13 300	*13 590	9 670			*11 440	7 470	8 940
	1,5 m	kg			*15 740	*15 740	*18 290	12 820	*14 460	9 400			11 580	7 350	8 940
	0 m	kg			*23 190	19 220	*18 930	12 570	14 860	9 240			12 020	7 600	8 680
	-1,5 m	kg	*16 930	*16 930	*24 370	19 290	*18 520	12 530	*14 460	9 220			*12 910	8 310	8 130
	-3,0 m	kg	*28 150	*28 150	*21 790	19 550	*16 760	12 690					*13 030	9 880	7 230
	-4,5 m	kg			*16 830	*16 830							*12 390	*12 390	5 810
with 600 mm shoe 9 300 kg CWT boom 7,0 m + arm 2,55 m	6,0 m	kg					*12 630	*12 630	*11 310	10 270			*10 980	8 060	8 710
	4,5 m	kg					*14 650	13 740	*12 250	9 940	*11 110	7 550	*11 060	7 260	9 220
	3,0 m	kg					*16 750	13 060	*13 350	9 590	*11 570	7 390	10 720	6 860	9 460
	1,5 m	kg					*18 240	12 590	*14 270	9 300	11 420	7 250	10 620	6 760	9 460
	0 m	kg					*18 790	12 380	14 730	9 130	11 330	7 170	10 970	6 950	9 210
	-1,5 m	kg			*23 890	19 060	*18 450	12 360	*14 580	9 100			11 920	7 520	8 700
	-3,0 m	kg	*25 020	*25 020	*21 800	19 310	*17 100	12 510	*13 300	9 250			*12 280	8 720	7 870
	-4,5 m	kg			*18 060	*18 060	*13 930	12 890					*12 020	11 390	6 590
with 600 mm shoe 9 300 kg CWT boom 7,0 m + arm 3,35 m	6,0 m	kg						*10 290	*10 290	*9 860	7 860		*8 660	7 210	9 460
	4,5 m	kg			*17 390	*17 390	*13 320	*13 320	*11 360	10 150	*10 320	7 700	*8 730	6 570	9 930
	3,0 m	kg			*22 140	*20 140	*15 620	13 380	*12 620	9 750	*10 980	7 490	*9 030	6 240	10 150
	1,5 m	kg			*14 340	*14 340	*17 490	12 790	*13 750	9 410	11 480	7 300	*9 580	6 140	10 150
	0 m	kg			*17 590	*17 590	*18 550	12 450	*14 520	9 170	11 330	7 160	9 860	6 270	9 920
	-1,5 m	kg	*12 690	*12 690	*25 020	18 910	*18 720	12 330	14 670	9 070	11 280	7 120	10 550	6 690	9 450
	-3,0 m	kg	*21 670	*21 670	*23 500	19 080	*17 960	12 390	*14 150	9 100			*11 590	7 540	8 690
	-4,5 m	kg	*27 480	*27 480	*20 640	19 440	*15 930	12 620	*11 970	9 360			*11 780	9 260	7 560
with 600 mm shoe 9 300 kg CWT boom 7,0 m + arm 3,9 m	6,0 m	kg						*9 450	*9 450	*9 090	7 890		*6 990	6 580	9 990
	4,5 m	kg					*12 190	*12 190	*10 560	10 180	*9 650	7 690	*7 050	6 020	10 440
	3,0 m	kg			*20 150	*20 150	*14 550	13 430	*11 880	9 740	*10 390	7 440	*7 280	5 720	10 650
	1,5 m	kg			*19 550	19 180	*16 630	12 740	*13 130	9 330	*11 130	7 210	*7 710	5 620	10 650
	0 m	kg			*19 410	18 640	*17 980	12 290	*14 060	9 040	11 200	7 030	*8 390	5 720	10 430
	-1,5 m	kg	*12 720	*12 720	*24 360	18 510	*18 480	12 090	14 470	8 880	11 100	6 940	*9 490	6 050	9 980
	-3,0 m	kg	*19 640	*19 640	*24 030	18 620	*18 090	12 090	*14 240	8 860	11 140	6 970	10 700	6 720	9 270
	-4,5 m	kg	*28 640	*28 640	*21 730	18 930	*16 620	12 260	*12 910	9 020			*11 180	8 030	8 220
	-6,0 m	kg			*17 480	*17 480	*13 150	12 700					*11 160	11 010	6 670
with 600 mm shoe 9 300 kg CWT boom 7,0 m + arm 4,8 m	6,0 m	kg								*7 930	*7 930		*6 480	5 820	10 760
	4,5 m	kg						*9 250	*9 250	*8 600	7 740		*6 570	5 350	11 180
	3,0 m	kg			*16 980	*16 980	*12 770	*12 770	*10 660	9 820	*9 440	7 440	*6 800	5 080	11 380
	1,5 m	kg			*21 240	19 530	*15 130	12 850	*12 070	9 340	*10 310	7 150	*7 200	4 980	11 380
	0 m	kg			*23 570	18 560	*16 920	12 230	*13 240	8 940	*11 050	6 910	*7 830	5 030	11 170
	-1,5 m	kg	*12 870	*12 870	*24 770	18 150	*17 920	11 880	*13 990	8 690	10 910	6 750	8 460	5 270	10 750
	-3,0 m	kg	*18 000	*18 000	*24 500	18 100	*18 090	11 750	14 180	8 590	10 850	6 690	9 250	5 750	10 090
	-4,5 m	kg	*24 690	*24 690	*23 070	18 290	*17 330	11 820	*13 590	8 640	*10 710	6 790	*10 430	6 660	9 140
	-6,0 m	kg	*28 230	*28 230	*20 130	18 720	*15 250	12 110	*11 580	8 900			*10 880	8 490	7 780

- Notes:
- Machine in "Fine Mode-F" (Power Boost), for lifting capacities.
 - The above loads are in compliance with SAE J1097 and ISO 10567 Hydraulic Excavator Lifting Capacity Standards.
 - Rated loads do not exceed 87% of hydraulic lifting capacity or 75% of tipping load.
 - Rated loads marked with an asterisk (*) are limited by hydraulic capacity rather than tipping load.

LIFTING CAPACITY (At the arm and without bucket)

Note: For lifting capacity including bucket, simply subtract actual weight of the direct fit bucket or the bucket with quick fit from the following values.

EC460B LC with mechanically retractable undercarriage

 Across undercarriage  Along undercarriage	Lifting hook related to ground level	3,0 m		4,5 m		6,0 m		7,5 m		9,0 m		Max. reach		
														Max. mm
with 600 mm shoe 9 300 kg CWT ME boom 6,5 m + arm 2,55 m	6,0 m kg					*13 000	*13 000	*11 890	10 360			*11 040	8 940	8 200
	4,5 m kg			*19 690	*19 690	*14 860	14 050	*12 670	10 090			*11 070	7 990	8 720
	3,0 m kg					*16 900	13 410	*13 680	9 770			*11 490	7 540	8 950
	1,5 m kg			*16 090	*16 090	*18 390	12 960	*14 520	9 510			11 770	7 460	8 920
	0 m kg			*24 220	19 480	*18 930	12 730	*14 880	9 360			12 280	7 750	8 640
	-1,5 m kg	*18 290	*18 290	*24 190	19 560	*18 420	12 710	*14 360	9 360			*12 940	8 530	8 060
	-3,0 m kg	*27 690	*27 690	*21 460	19 840	*16 490	12 890					*13 020	10 240	7 120
	-4,5 m kg													
with 600 mm shoe 9 300 kg CWT boom 7,0 m + arm 2,55 m	6,0 m kg					*12 800	*12 800	*11 380	10 380			*10 980	8 080	8 770
	4,5 m kg					*14 850	13 860	*12 350	10 050	*11 150	7 650	*11 070	7 310	9 250
	3,0 m kg					*16 930	13 190	*13 450	9 700	*11 620	7 490	10 870	6 940	9 470
	1,5 m kg					*18 330	12 740	*14 340	9 420	11 590	7 350	10 800	6 870	9 450
	0 m kg			*13 680	*13 680	*18 790	12 550	*14 770	9 260	11 510	7 280	11 210	7 100	9 180
	-1,5 m kg			*23 740	19 350	*18 370	12 550	*14 520	9 240			*12 120	7 720	8 640
	-3,0 m kg	*26 440	*26 440	*21 540	19 620	*16 910	12 720	*13 070	9 410			*12 290	9 020	7 770
	-4,5 m kg			*17 570	*17 570	*13 430	13 140					*11 940	*11 940	6 440
with 600 mm shoe 9 300 kg CWT boom 7,0 m + arm 3,35 m	6,0 m kg							*10 380	*10 380	*9 890	7 950	*8 660	7 230	9 510
	4,5 m kg			*17 850	*17 850	*13 540	*13 540	*11 480	10 240	*10 380	7 780	*8 750	6 620	9 960
	3,0 m kg			*20 610	20 270	*15 820	13 480	*12 730	9 850	*11 040	7 580	*9 060	6 310	10 160
	1,5 m kg			*14 380	*14 380	*17 630	12 920	*13 840	9 510	11 630	7 390	*9 650	6 230	10 140
	0 m kg			*18 140	*18 140	*18 600	12 600	*14 560	9 290	11 490	7 260	10 060	6 390	9 890
	-1,5 m kg	*13 490	*13 490	*24 950	19 180	*18 690	12 500	*14 710	9 190	11 450	7 220	10 800	6 840	9 390
	-3,0 m kg	*22 600	*22 600	*23 300	19 360	*17 840	12 570	*14 040	9 250			*11 610	7 760	8 600
	-4,5 m kg	*26 930	*26 930	*20 270	19 740	*15 640	12 830					*11 780	9 640	7 430
with 600 mm shoe 9 300 kg CWT boom 7,0 m + arm 3,9 m	6,0 m kg							*9 540	*9 540	*9 130	7 980	*6 990	6 610	10 050
	4,5 m kg					*12 410	*12 410	*10 680	10 280	*9 720	7 770	*7 060	6 070	10 470
	3,0 m kg			*20 550	*20 550	*14 770	13 550	*12 000	9 830	*10 460	7 530	*7 310	5 790	10 660
	1,5 m kg			*19 150	*19 150	*16 790	12 870	*13 230	9 440	*11 190	7 300	*7 760	5 710	10 640
	0 m kg			*19 710	18 890	*18 060	12 450	*14 120	9 160	11 370	7 130	*8 480	5 830	10 400
	-1,5 m kg	*13 320	*13 320	*25 000	18 790	*18 480	12 270	*14 500	9 010	11 280	7 040	*9 610	6 190	9 930
	-3,0 m kg	*20 360	*20 360	*23 870	18 910	*18 010	12 280	*14 180	9 010	*11 280	7 100	*10 890	6 920	9 190
	-4,5 m kg	*29 500	*29 500	*21 440	19 240	*16 410	12 480	*12 690	9 190			*11 200	8 340	8 100
	-6,0 m kg			*16 920	*16 920	*12 620	*12 620					*11 120	*11 120	6 490
with 600 mm shoe 9 300 kg CWT boom 7,0 m + arm 4,8 m	6,0 m kg									*7 980	*7 980	*6 480	5 860	10 810
	4,5 m kg							*9 370	*9 370	*8 670	7 820	*6 580	5 400	11 200
	3,0 m kg			*17 420	*17 420	*13 000	*13 000	*10 790	9 910	*9 520	7 530	*6 830	5 150	11 390
	1,5 m kg			*21 560	19 680	*15 330	12 970	*12 190	9 430	*10 380	7 240	*7 250	5 060	11 370
	0 m kg			*23 460	18 780	*17 040	12 370	*13 330	9 050	*11 110	7 000	*7 910	5 130	11 140
	-1,5 m kg	*13 300	*13 300	*24 790	18 410	*17 970	12 040	*14 030	8 810	11 090	6 850	8 660	5 390	10 700
	-3,0 m kg	*18 540	*18 540	*24 420	18 380	*18 060	11 930	*14 160	8 720	11 040	6 800	9 510	5 910	10 020
	-4,5 m kg	*25 430	*25 430	*22 870	18 590	*17 210	12 020	*13 480	8 790	*10 550	6 920	*10 480	6 880	9 030
	-6,0 m kg	*27 620	*27 620	*19 750	19 050	*14 960	12 330	*11 250	9 090			*10 910	8 890	7 630

- Notes:
- Machine in "Fine Mode-F" (Power Boost), for lifting capacities.
 - The above loads are in compliance with SAE J1097 and ISO 10567 Hydraulic Excavator Lifting Capacity Standards.
 - Rated loads do not exceed 87% of hydraulic lifting capacity or 75% of tipping load.
 - Rated loads marked with an asterisk (*) are limited by hydraulic capacity rather than tipping load.

STANDARD EQUIPMENT

Engine

Turbocharged, 4 stroke diesel engine with water cooling, direct injection and charged air cooler that meets EU Stage IIIA requirements
3-stage air filter with indicator, and pre-cleaner
Air intake heater
Electric engine shut-off
Fuel filter and water separator
Fuel filler pump: 50 l/min with automatic shut-off
Coolant filter
Alternator, 80 A

Electric / Electronic control system

Contronics:
- Advanced mode control system
- Self-diagnostic system
Machine status indication
Engine speed sensing power control "Power Max" mode system
Automatic idling system

One-touch power boost
Safety stop/start function
Adjustable monitor
Master switch
Engine restart prevention circuit
High capacity halogen lights:
- Frame mounted 2
- Boom mounted 4
Batteries, 2 x 12 V / 200 Ah
Start motor, 24 V / 6,6 kW

Hydraulic system

Automatic hydraulic system:
- Summation system
- Boom priority
- Arm priority
- Slew priority
Boom and arm regeneration valves
Slew anti-rebound valves
Boom and arm holding valves
Multi-stage filtering system
Cylinder cushioning
Cylinder contamination seals
Hose rupture valve: boom
Auxiliary hydraulic valve

Straight travel circuit
Automatic two-speed travel motors
Hydraulic oil, ISO VG 46

Superstructure

Access way with handrail
Tool storage area
Punched metal anti-slip plates
Undercover (heavy duty 4,5 mm)
Counterweight, 9 300 kg

Cab and interior

Heater & air-conditioner, automatic
Hydraulic dampening cab mounts
Adjustable operator seat and joystick control console
Flexible antenna
Hydraulic safety lock lever
Control joystick, with 5 switches each
Cab, all-weather sound suppressed, includes:
- Ashtray
- Cup holder
- Lighter
- Door locks

- Tinted glass
- Floor mat
- Horn
- Large storage area
- Pull-up type front window
- Removable lower windshield
- Seat belt
- Safety glass
- Windshield wiper with intermittent feature
- Sun shield, front, roof, rear
- Stereo cassette radio
Anti-vandalism kit assembly preparation
Master ignition key

Undercarriage

Hydraulic track adjusters
Greased and sealed track chain
Track guards
Undercover (heavy duty 10 mm)

Service

Tool kit, daily maintenance

ALTERNATIVE EQUIPMENT

Cab and interior

Seat:
- Fabric seat
- Fabric seat, with heater
- Fabric seat, with heater and air suspension

Track shoes

600 / 700 / 800 / 900 mm track shoes with triple grousers
600 mm track shoe with double grouser

Digging equipment:

Boom: 6,5 m monoblock, ME
7,0 m monoblock
Arm: 2,55 / 3,35 / 3,9 / 4,8 m

OPTIONAL EQUIPMENT (Standard in certain markets)

Engine

Block heater, 240 V
Oil bath pre-cleaner
Diesel coolant heater

Electric

Extra lamps:
- Cab-mounted 3, (front 2, rear 1)
- Counterweight-mounted 1
Overload warning device
Rotating warning beacon
Travel alarm

Hydraulic system

Hose rupture valve: dipper arm
Hydraulic piping
- Hammer & shears:
1 pump or 2 pump flow
Pump flow control for hammer & shears
Additional return filter
Extra piping for slope & rotator
- Slope & rotator
- Grapple
- Oil leak (drain) line
- Quick fit piping
Volvo hydraulic quick-fit, S3 size
Hydraulic oil, ISO VG 32
Hydraulic oil, ISO VG 68

Hydraulic oil, biodegradable 32
Hydraulic oil, biodegradable 46
Boom floating function
Straight travel pedal

Superstructure

Service walk
Cab entrance step
Hydraulically removable counterweight

Cab and interior

Falling object guard (FOG)
Cab mounted falling object protective structures (FOPS)
Rain shield, front

Sunlight protection, roof (steel)
Safety net for front window
Lower wiper
Anti-vandalism kit
Specific key

Undercarriage

Full track guards
Mechanically retractable track gauge

Service

Tool kit, full scale

All products are not available in all markets. Under our policy of continuous improvement, we reserve the right to change specifications and designs without prior notice. The illustrations do not necessarily show the standard version of the machine.

VOLVO

Construction Equipment
www.volvo.com

Ref. No. 21 E 435 1646
Printed in Sweden 2005.12-1,0
Volvo, Eskilstuna

English
EXB