

VOLVO WHEELED EXCAVATOR
EW160C

16,4 – 18,0 t, 156 metric hp



MORE CARE. BUILT IN.



VOLVO – A PARTNER TO TRUST.

Trust means knowing your equipment will perform no matter the job or the conditions. Volvo EW160C wheeled excavators earn that trust — every day. With the multi-task credentials of a tool carrier and the pedigree of a thoroughbred digging machine, the EW160C does more than work. It commands.

Multi-function. Highly mobile. Well-balanced. Fuel efficient. Comfortable. Think of the Volvo EW160C as your one-machine fleet. It's time to roll.

Volvo: your global, local partner

Since 1927, Volvo has earned trust for providing solutions with true value. Built on core values of quality, safety and environmental care, Volvo equipment is a leader in construction and transportation. Its extensive lineup of construction machines is complemented by Volvo buses, trucks, aero engines and marine power systems. As the world's largest producer of 9- to 18-liter diesel engines, Volvo delivers class-leading fuel efficiency. That heritage is born anew in the C-Series family of excavators. One shift in the cab of a Volvo excavator and you'll understand why so many count on Volvo as their trusted partner.

A task force from one machine

Other machines may try to claim the crown, but Volvo C-Series wheeled excavators are arguably the most capable construction machines at work anywhere. So what is an excavator doing making such claims? Watch and see. The EW160C is one machine, but it performs the work of a task force. Digging trenches. Hammering impacted rock. Setting up trench boxes. Grading. Craning

pipes. Boring holes for utility poles. Sawing concrete bridge decks. Pulling storm debris from under bridges.

All that in a well-balanced package that moves between job sites at up to 35 km/h. The EW160C won't tear up road surfaces or parking lots like crawler machines. And its low ground pressure makes it especially effective in off-road or soft-ground conditions. Count on it.

Cab puts the operator in command

The roomier Volvo Care Cab has excellent visibility, high-volume climate control, a new openable roof hatch and repositionable steering column. The responsive controls allow the operator to infinitely adjust hydraulic flow and pressure for attachments without leaving the seat. Fluid levels can be monitored right from the cab.

With such mobility, ease of use, comfort and adaptability, the EW160C truly has the power of more. More tools. More tasks. More control. More work done — on less fuel. At the end of the day it adds up to the one thing all contractors want — more profit.





• High torque and smooth ride redefine mobility.



• Volvo Care Cab has excellent visibility.



• All-around excavator/tool-carrier performance.



• Volvo is a sure sign of innovation and quality.



• Extra-duty components deliver reliable, long life.



• Efficient, intelligent Volvo V-ACT engine.

- Rugged, mobile tool carrier efficiently handles the work of several machines.
- Adjust attachment hydraulic flow and pressure right from the cab.
- Cab comfort, clear visibility enhance productivity.
- V-ACT engine has high torque at low revs and superior fuel efficiency.

A CAB THIS GOOD COULD ONLY COME FROM VOLVO.

Why is the new Volvo C-Series Care Cab so roomy, comfortable and secure? Simple. Volvo knows the excavator operator is that important.

We made the EW160C cab roomier, expanded the cab glass, added a transparent, openable roof hatch option and made everything from the seat to the steering column easy to customize for just the right fit. We make it easy to do more — in comfort.

No better place to work

One shift at the controls of the EW160C and an operator will never want to run anything but a Volvo. Operator input is a big part of Volvo cab design, so it's no surprise the EW160C Care Cab is loaded with productivity-enhancing features. It's not only good for the operator, it's a competitive edge for the owner. Productivity and profit start in the cab.

It's easier than ever to be productive — right from the operator's seat. Daily checks of engine oil, coolant, hydraulic oil and filters can be done via the easy-to-read electronic control monitor. No more climbing on the excavator for daily checks. The optional Volvo CareTrack system works with the machine's diagnostics to track geographic location, usage, fuel consumption, service reminders and more. Using GPS technology, CareTrack makes the information available remotely via computer. CareTrack also offers theft protection by allowing you to limit geographic areas or hours of the day the machine can be operated.

Switching attachments is fast and convenient. The EW160C works with three types of quick couplers (S-1, S-6 or universal), and can be outfitted with the widest range of attachments.

The operator can adjust hydraulic flow and pressure settings from the cab — a major time saver when doing tool-carrier work. Volvo hydraulics provide smooth, comfortable control with low effort from the joysticks. And the ride is smooth, whether roading at full speed or operating in creep mode.

Visibly superior

Volvo is already known for industry leading cab visibility. Now we've made it even better with more cab glass and a transparent roof hatch that opens via a gas strut. Visibility has been dramatically improved by moving the windshield-wiper motor to the left and the wiper cleans a wider area. The steering column pivots back and forth, so it won't obstruct view to the front. With the two-piece boom retracted, visibility out the right side is clear and unobstructed for travel.

An optional rear-view camera is integrated into the in-cab monitor for extra safety. Digging, lifting or craning, the operator has the cleanest lines of sight, for added confidence and better productivity.

We've relocated the cooling system fan, so the pressurized cab is even quieter. A new viscous-mount suspension cushions the platform from vibration, so long shifts won't mean big fatigue. An improved seat enhances comfort — and significantly reduces whole-body vibration.



• Rear visibility is enhanced by flat superstructure.

- Deluxe air-suspension seat with adjustable height, tilt, recline and forward-back settings to easily suit any size operator.
- Joystick consoles adjust up, down, forward and back.
- Forward-reverse switch on right joystick provides superior control, lessens leg fatigue compared with F/R pedal.
- Wider cab with more leg room and foot space.
- Electronic control console allows daily fluid and filter checks right from the cab.
- Generous cab glass enhances industry-leading visibility.
- Transparent, openable roof hatch offers clean sight lines for overhead operations.
- Retractable steering column pivots toward operator for clean field of view.
- Removable lower front window stows easily in cab door pocket.
- Optional rear camera provides added safety and increased operator confidence.
- New viscous-mount suspension dampens shock and vibration.
- 14-vent climate-control keeps cab air comfortable in any weather.



• Steering column pivots for visibility and comfort.

• Machine controls are all within easy reach.

• Clear overhead views through openable roof.



FLEET PRODUCTION — FROM ONE MACHINE.

Every contractor looks for a competitive edge, which is why Volvo built so many into its line of wheeled excavators. The EW160C is a superior tool carrier that can perform the work of several machines — at lower cost and higher profit.

With so many options, from buckets and hammers to grapples and clamps, the EW160C is more than a machine. It's an all-around force.

One machine, many solutions

The Volvo EW160C is a true tool commander, engineered with the power and stability to handle the work of several machines. With a multitude of available attachments and the ability to customize hydraulic flow and pressure right from the cab, the EW160C has the power and quality of a whole fleet — built in.

The stout, solid undercarriage anchors the machine for digging, lifting and precision operations. With robust, wide-spread outriggers and parallel blade, the EW160C can lift, load, grade and more. And it won't tear up roadway pavement or mar other sensitive surfaces. With low ground pressure, it's an outstanding tool for off-road operations.

Versatility starts with the EW160C's boom. The available two-piece boom delivers incredible agility, allowing the excavator to work in tight spaces or perform parallel digging. The geometry of the two-piece boom makes the EW160C perfectly suited for a huge range of tasks. The standard monoboom delivers solid performance for digging and lifting applications.

Work tools for any task

Tool-carrier performance of the EW160C is limited only by the needs of the customer. Add a quick fit and a tilting, rotating attachment for a truly smart machine. The EW160C works with S-1, S-6 and universal quick coupler, so there's virtually no limit on available attachments.

Smooth, load-sensing hydraulics deliver the control for asphalt cutting or grading around obstructions. Superior hydraulics can power hammers, grapples, brush cutters and many other attachments. Easily arm the EW160C with ditching or trenching buckets, rippers, compactors, augers, mowers, pulverizers — and more.

All of this performance is made more effective by the EW160C's smooth travel at speeds up to 35 km/h. So whether the work is across the job site or across town, the EW160C takes the command where you need it most.





• Precise control for working in tight spaces.



• Robust hydraulics, stability for off-road operation.



• Reach and power for digging and loading.



• Optional two-piece boom adds versatility.



• 3 possible couplers for wide attachment range.

- With a range of attachments, do more with one machine.
- Operate off road or on pavement without damaging sensitive surfaces.
- Quick coupler makes swapping attachments quick and easy.
- Stabilizer blade and outriggers enhance stability for digging or lifting.
- Comfortable ride whether at full speed or in creep mode.

VOLVO POWER IS THE HEART OF PERFORMANCE.

To truly understand the advantage of operating a machine with a Volvo power system, you have to experience it. One shift at the controls of the EW160C and you'll know it. It shows in power out of the trench. It shows in the fine control placing pipes or pallets of material. It shows in high torque at low RPMs. It shows in world-class fuel economy. Most importantly, it shows in productivity — and profit.



• Tested, and proven, on job sites all over the world.

Superior power — with purpose

As the world's leading manufacturer of mid-size diesel engines, Volvo knows power. The EW160C is a mid-size excavator with a robust six-cylinder engine — perfect balance of power and size. It's no wonder the EW160C is so good at so many tasks.

What gives Volvo power a competitive edge on the job site? Superior components are perfectly integrated with Volvo technology to get the most from every stroke, cycle and shift.

Electronic engine controls optimize hydraulic flow based on engine speed and the demands of the job. Operators have engine modes to match the widest

range of tasks. Volvo delivers total power control, so you're assured of maximum output at any speed. The EW160C delivers faster operation at lower revs.

The advanced Volvo V-ACT engine meets Tier 3/Stage IIIA emissions requirements, so it's easy on the environment. You'll squeeze more from every drop of fuel with V-ACT, which uses new fuel-injection and air-management systems for clean combustion and low emissions.

Robust, harmonized hydraulics

The quieter main pump delivers robust oil flow to hydraulic, travel and swing functions for smooth and responsive performance — especially on combined tool-carrier operations. A higher torque

swing motor means faster cycle times when working on slopes or placing loads.

Based on the proven Volvo wheel loader engine and specifically designed for the demands of excavation, the EW160C has more components and parts found in other Volvo equipment. That means better parts availability, lower operating costs and better uptime.

Volvo takes the power even further with VCADS Pro and MATRIS — computerized tools to analyze and manage fuel usage, machine function and utilization. Volvo CareTrack brings the power of satellites to track and manage one machine — or an entire fleet.

VOLVO'S ENGINE LEADERSHIP SPANS LAND, SEA, SKY AND SPACE

As the world's largest manufacturer of 9-to 18-liter diesel engines, Volvo has unmatched expertise designing power systems that move the world. Volvo engines for Volvo Construction Equip-

ment, Volvo Aero, Volvo Buses, Volvo Penta and Volvo Trucks define productivity and fuel economy. Our performance has been honed on land, over the sea, across the sky and into space. Leading research and

development keeps all Volvo Group products at the forefront of productivity. So when we say Volvo engines are tested — and proven — you can believe it. Trust in it. It's the real advantage of Volvo Power.





• Custom performance with easy mode control.

• Hydraulics optimize flow based on job demands.

• Trust Volvo for power, endurance and results.



• Engines are built for multi-task performance.

High-torque V-ACT engine

- Precision, high-pressure fuel injection system.
- Larger capacity turbocharger.
- Innovative exhaust recirculation.
- High torque at low RPMs
- Industry-leading fuel economy.

Electronic engine control

- Real-time sensors feed data to engine management system.
- System optimizes combustion based on sensor feedback.
- Maximum available power directed to hydraulics.

Hydraulics with harmony

- Maximum available hydraulic power matched to engine speed.
- Volvo hydraulics ensure the flow is directed to where it's needed.

Telematics machine management

- Volvo CareTrack telematics system harnesses satellites for remote monitoring.
- Track location, operation data, error codes, alarms and more.
- Diagnostics, machine history available from MATRIS and VCADS Pro systems.

A CLOSE-UP VIEW OF ROLLING COMMAND: INNOVATION NEVER LOOKED SO GOOD.

MORE SAFETY

- **Safety** is a **core value** at Volvo and it shows in our machines.
- **Rollover protective structure (ROPS)** integrated in cab pillars.
- **Optional rear camera** provides the operator with more confidence.
- Superstructure above the engine is flat for **excellent rear visibility**.
- **Punched-plate anti-slip steps and walkways** for sure grip.
- **Longer cabin footstep** resists damage and is easily replaced.
- **Low noise levels** in the cab and outside the machine.
- **In-cab switch shuts down engine in an emergency**.
- **Clear, openable roof hatch** for clear views of overhead obstructions.
- **Indicator on quick fit** shows if attachments are locked in place.
- **Fuel-efficient, low-emissions engine** is easy on the environment.
- **Lead-free exterior paint**.
- **Volvo excavators are 95% recyclable**.

MORE SOLUTIONS

- **Auxiliary hydraulics** power a range of attachments:
 - Grapples
 - Slope bucket
 - Tilting & rotating attachment
 - Brush cutters
 - Compactors
 - Augers
 - Pile drivers
 - Pulverizers
 - Hammers
- **One-touch customization** of attachment hydraulic pressures and flows, activated from joystick button in the cab.
- **Full hammer/shear control** from the cab, including flow control, pressure adjustment and ability to store and recall unlimited attachment presets from keypad in the cab.
- **Volvo quick coupler**.
- Available **tilting & rotating attachment** provides 360-degree attachment rotation, extreme agility.
- Available **two-piece boom** enhances work on cramped sites, aids visibility when roading.
- Volvo's **offset boom** delivers great versatility for digging work in narrow spaces.





MORE CAB COMFORT

- **Roomier Volvo Care Cab** with customizable controls and backlit switches.
- **More cab glass** delivers enhanced best-in-class visibility.
- **Pivoting, ergonomic steering column** ensures clean lines of sight.
- **Convenient forward-reverse travel switch** on right joystick.
- **Operator shielded from vibration** by viscous-mounted platform.
- **High-capacity heating and cooling** for comfort in any weather.

MORE PROFIT

- **World-class Volvo engine** with industry-leading fuel economy.
- **New low-emissions Volvo V-ACT engine.**
- **Proven hydraulics:** optimum power where it's needed.
- **Harmonized power** with oil regeneration and priority features for faster cycles and more productivity per shift.

MORE QUALITY

- **Heavy-gauge outriggers have wide stance** for excellent stability.
- **Stabilizer blade** has wide footprint, so it **won't damage pavement.**
- **Stout and solid undercarriage.**
- **Extra-duty boom and arm.**
- **Long wheel base** for added stability and smoother ride.

MORE UPTIME

- **Electronic control unit** monitors and troubleshoots all functions.
- **Easy-to-change cab air filter is located outside the cab.**
- **Cooling system is easier to clean.**
- **Daily checks done from the cab** using control monitor.
- **Long-life hydraulic oil** with 4,000-hour change interval.
- Convenient **centralized remote greasing.**
- **Satellite-based CareTrack system** monitors and troubleshoots machine operation, location, error codes and more.

CUSTOMIZABLE MACHINE OPTIONS GIVE YOU THE POWER TO DO MORE.

Volvo C-Series wheeled excavators have productivity and profit built in, but the story doesn't stop there. Volvo offers a wealth of machine options — from hydraulic kits, work lights, and operator seats to a rear-view camera and cold-weather starting system. Volvo delivers more protection, more comfort, more convenience, more strength — and more options.

Electronic climate control

High-capacity heating, cooling and ventilation with electronic climate control keeps the cab comfortable no matter the weather. A heater with manual control is included standard.

Anti-theft system

A security code must be entered on the instrument panel in order to start the engine. The code can be changed by VCADS-Pro. For repeated starts, the system can be set not to require the code for predetermined time periods.

Cab protection with FOG, FOPS

Falling Object Guard (FOG) and Falling Object Protection Structure (FOPS) provide safety and confidence in tough applications like demolition or quarrying. The front of the FOG tilts on gas struts for easy window cleaning.

Hydraulic quick fit

Expand your excavator's capabilities with a hydraulic quick fit for fast, easy change out of buckets and attachments — right from the cab.

Tilting, rotating attachment solution

A tilting, rotating attachment solution provides incredible versatility, allowing you to rotate 360 degrees and tilt bucket or attachment 40 degrees.

Hydraulic kits

Get the most from hammers, crushers and tilting/rotating attachments with a wide selection of hydraulic kits. Optimize flow and power based on boom and arm

lengths. Available in one- and two-pump-flow configurations to suit job needs.

Ergonomic operator seats

A variety of ergonomic, high-performance seats include advanced air-suspension models for extreme comfort. All seats are fully adjustable to fit any size operator.

Wrist-control joysticks

Volvo's low-effort, wrist-control joysticks deliver smooth and even performance that lessens operator fatigue and increases job performance. Wrist control joysticks with proportional-control switches are also available.

Engine coolant heater

The diesel-driven engine coolant heater eases start-ups in cold weather while simultaneously warming the cab. Heating times are adjustable, and the system can be pre-set to engage automatically.

Work lights, rotating beacon

Increase visibility with rear-facing halogen lights on the counterweight, at cab roof and front-facing lights on both sides of the boom. A rotating amber beacon makes the machine more visible on the job site, and when moving the machine on the road.

Rear-view camera

The in-cab LCD monitor provides clear rear views for reverse travel and slewing operations, giving the operator confidence and boosting job-site safety.

Twin or single tires

Choose from single or twin tires to match terrain and job-site conditions.





Electronic climate control



Anti-theft system



FOG, FOPS cab protection



Volvo quick fit



Tilting, rotating attachments solution



Hydraulic kits



Suspension seats



Proportional-control joysticks



Diesel coolant heater with timer



Extra halogen lamps, beacon



Rearview camera



Twin tires or single tires

SPECIFICATIONS

Engine

The next-generation Volvo diesel engine uses Volvo Advanced Combustion Technology (V-ACT) to deliver lower emissions and maintain superior performance and fuel efficiency. The EU Stage IIIA compliant engine uses precise, high-pressure fuel injectors, turbo charger and air to air intercooler, and electronic engine controls to optimize machine performance.

Engine	VOLVO D6E EDE3
Power out at	30,0 r/s (1 800 rpm)
Gross (SAE J1995)	115 kW (156 metric hp)
Net (ISO 9249, DIN 6271)	106 kW (144 metric hp)
Max. torque at 1350 rpm	730 Nm
No. of cylinders	6
Displacement	5,7 l
Bore	98 mm
Stroke	126 mm

Electrical system

High-capacity electrical system that is well protected. Waterproof double-lock harness plugs are used to secure corrosion-free connections. The main relays and solenoid valves are shielded to prevent damage. The master switch is standard.

Voltage	24 V
Battery	2 x 12 V
Battery capacity	2 x 140 Ah
Alternator	28 V / 80 A
Alternator rating	2 240 W

Cab

New-design Volvo Care Cab with operator protective structure, large and roomy interior, more leg room and foot space. One way travel pedal with rocker switch control (F-N-R) on the right joystick. One-touch release for digging brake pedal. Audio system with remote control. 3 cup holders, 3 outlets, independently adjustable joystick consoles. Excellent all-round visibility provided by maximized cab class, transparent roof hatch, 2-piece sliding door window and longstroke, easy to adjust and narrow steering column. The liftable front windshield can easily be stored in the inside roof space and clipped in position. The removable lower front glass can be stored in the side door pocket. Interior lighting consists of one reading light and one light with timer. The pressurized and filtered cab air is supplied by a 14-vent climate-control providing fast defrosting and high cooling and heating performance. Viscous / spring mounted suspension cushions protect the operator from vibrations. Deluxe air-suspension seat with adjustable seat suspension, height, tilt, recline and forward-backward settings.

Adjustable, easy to read 6.4" LCD color monitor provides real time information of machine functions and important diagnostic information and is switchable to rear view camera monitor (option).

Sound Level:

In cab, acc. to ISO 6396	70 LpA dB(A)
External, acc. to ISO 6395	101 LwA dB(A)
(Directive 2000/14/EC)	

Undercarriage

Drive train: One big variable axial-piston motor on the two-step Power Shift gearbox gives power to front and rear axles, both with hub reductions.

Framework: All-welded robust torsion box frame.
Wheels: Alternative single and twin wheels available.

Front axle: Robust excavator axle with automatic or operator controlled front axle oscillation lock. Oscillating $\pm 9^\circ$ (with mudguards $\pm 7^\circ$).

Twin wheels	10,00–20
Max. tractive force (net)	99,5 kN
Travel speed:	
on road	20,0/30,0/35,0 km/h
off road	5,0/7,4/8,7 km/h
creep	3,7 km/h
Min. turning radius	7,3 m

Brakes

Service brakes: servo-hydraulically manoeuvred self-adjusting wet multidiscs with two separate brake circuits.

Parking brake: negative wet disc in gear housing, spring applied and pressure released.

Digging brake: service brake with mechanical lock system.

Security system: The 2-circuit travel brakes are supplied with two accumulators in the event of failure in the service brake system.

Total machine weights

Machine with 5,0 m monoblock boom, 2,45 m dipper arm, quickfit S6, 530 kg / 750 l bucket.

Dozer blade front and outriggers rear	17 430 kg / 17 770* kg
Dozer blade rear excl. outriggers	16 350 kg / 16 690* kg
Front and rear outriggers	17 680 kg / 18 020* kg

* Machine with 5,1m 2-piece boom.

Service refill capacities

Fuel tank	250 l
Hydraulic system, total	260 l
Hydraulic tank	123 l
Engine oil	25 l
Engine coolant	27 l
Transmission	2,5 l
Axel differential:	
Front axle	9,5 l
Rear axle	12,5 l
Final drive, wet disc type	4 x 2,5 l

Hydraulic system

Closed-centre load sensing hydraulic system with pressure compensated valves. Load independence of movements. Flow sharing feature, combined with a high flow electronically controlled pump (power regulation). The system gives superior manoeuvrability and fast movements, for optimal working result and economy.

The following working modes are included in the system:

Parking mode (P): Parking position for optimal safety.

Travel mode (T): Engine speed is controlled by travel pedal stroke for low fuel consumption and noise.

Working mode (W): Full working flow with adjustable engine rpm for normal working and best speed utilisation.

Customer mode (C): Operator can set proper oil flow in accordance with job conditions.

Power Boost: All digging and lifting forces are increased.

Hydraulic pumps:

Max. flows:	
Main pump	243 l/min
(type low noise axial piston pump)	
Brake + steering pump	38,0 l/min
(type low noise gear pump)	
Servo pump	14,0 l/min
(type low noise gear pump)	
Hydraulic oil cooling fan + pilot pump	49,0 l/min
(type gear pump)	
Max. pressure:	
Implements	32,5/36 MPa
Travel system	36 MPa
Pilot System	3,5 MPa

Slew system

The superstructure is slewed by the means of a radial piston motor without reduction gear. Automatic slew holding brake and anti-rebound valve are standard.

Max slew speed	10,0 rpm
Max. slew torque	49,6 kNm

Dimensions

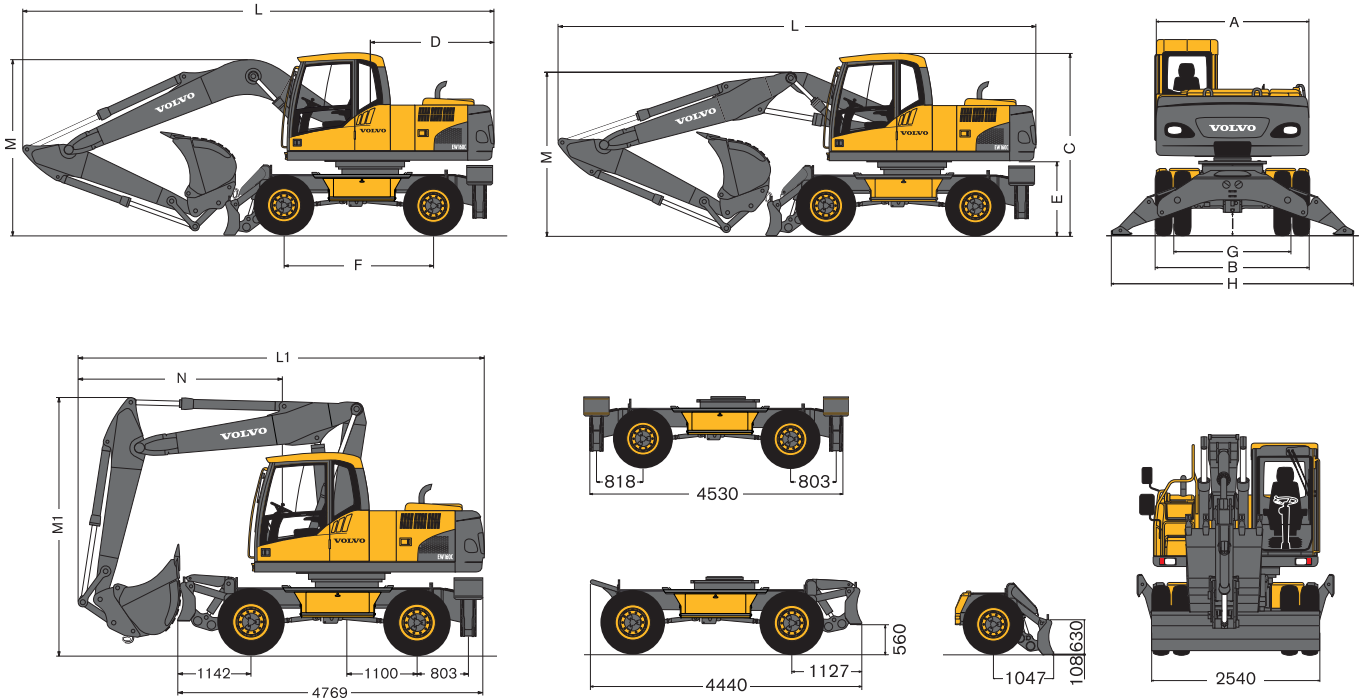

Description	Unit	5,0 m	5,1 m	4,75 m	5,2 m
		Monoblock boom	2-piece boom	Mono offset boom	2-piece offset boom
A. Overall width of superstructure	mm	2 490	2 490	2 490	2 490
B. Overall width	mm	2 540	2 540	2 540	2 540
C. Overall height of cab	mm	3 140	3 140	3 140	3 140
D. Tail slew radius	mm	2 150	2 150	2 150	2 150
E. Counterweight clearance	mm	1 270	1 270	1 270	1 270
F. Wheel base	mm	2 600	2 600	2 600	2 600
G. Tread	mm	1 940	1 940	1 940	1 940
H. Outrigger width (front or rear)	mm	3 920	3 920	3 920	3 920
I. Min. ground clearance	mm	340	340	340	340

Description	Unit	5,0 m Monoblock boom					5,1 m 2-piece boom				
		2,0 m	2,45 m	2,6 m	3,1 m	2,95 m*	2,0 m	2,45 m	2,6 m	3,1 m	2,95 m*
L. Overall length	mm	8 180	8 190	8 170	7 940	8 210*	8 300	8 310	8 290	8 100	8 300*
M. Overall height of boom	mm	2 960	3 190	3 270	3 640	3 155*	2 765	2 885	2 975	3 390	2 960*
L1. Overall length	mm						6 305	6 345	6 355	6 545**	6 000*
M1. Overall height of boom	mm						3 960	3 995	4 000	4 000**	3 950*
N. Front overhang	mm						3 125	3 165	3 175	3 360**	2 820*

Description	Unit	4,75 m Mono offset boom				5,2 m 2-piece offset boom			
		2,0 m	2,45 m	2,6 m	3,1 m	2,0 m	2,45 m	2,6 m	3,1 m
L. Overall length	mm	7 800	7 800	7 770	7 570	8 330	8 340	8 340	8 230
M. Overall height of boom	mm	2 850	3 320	3 440	3 870	2 910	2 875	2 920	3 340
L1. Overall length	mm					6 160	6 190	6 215	6 130**
M1. Overall height of boom	mm					4 000	4 000	4 000	4 000**
N. Front overhang	mm					2 980	3 000	3 030	2 950**

*grab arm, without clamshell bucket
** without bucket

Working ranges & digging forces

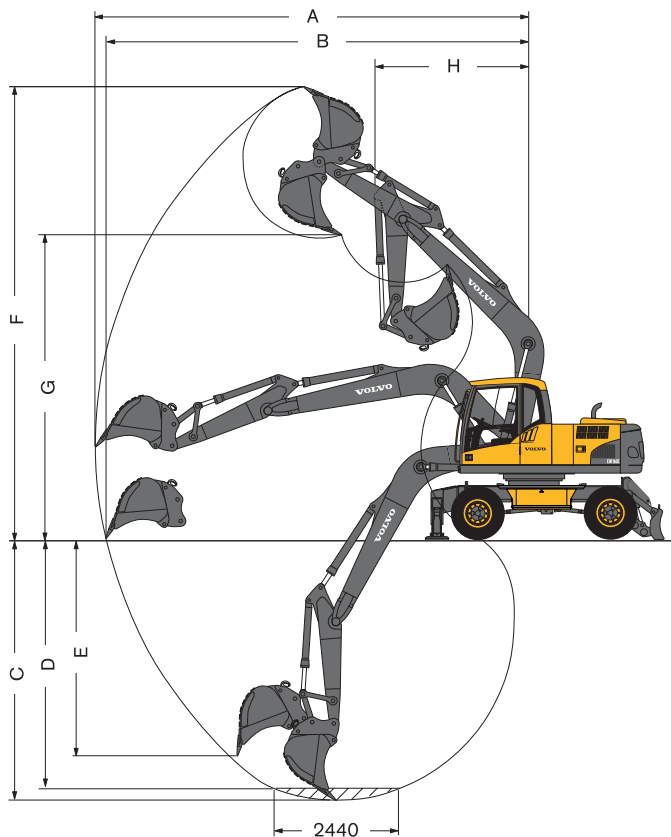

Monoblock boom 5,0 m and dipper arm 2,0 m, 2,45 m, 2,6 m, 3,1 m

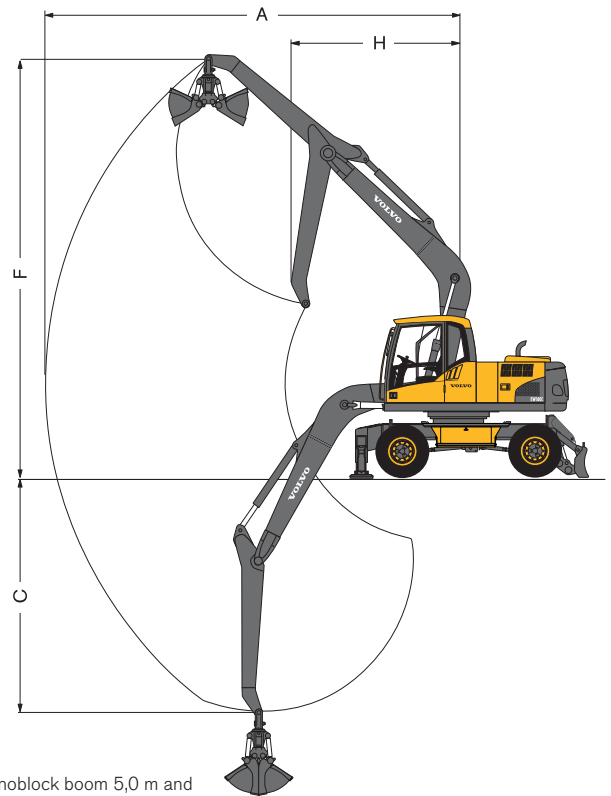

Monoblock boom 5,0 m and grab arm 2,95 m

Description	Unit	5,0 m Monoblock boom				
		2,0 m arm	2,45 m arm	2,6 m arm	3,1 m arm	2,95 m Grab arm
A. Max. digging reach	mm	8 590	9 010	9 160	9 630	8 050
B. Max. digging reach on ground	mm	8 390	8 820	8 970	9 460	
C. Max. digging depth	mm	5 140	5 590	5 740	6 240	4 590
D. Max. digging depth (2 440 mm level)	mm	4 910	5 390	5 550	6 070	
E. Max. vertical wall digging depth	mm	4 270	4 690	4 840	5 310	
F. Max. cutting height	mm	8 850	9 110	9 200	9 480	8 090
G. Max. dumping height	mm	5 950	6 190	6 240	6 560	
H. Min. front slew radius	mm	3 140	3 150	3 160	3 190	3 270
Digging forces with direct fit bucket						
Bucket radius	mm	1 350	1 350	1 350	1 350	
Breakout force - bucket	(SAE/ISO) kN	108,0 / 122,7	108,0 / 122,7	108,0 / 122,7	108,0 / 122,7	
Tearout force	(SAE/ISO) kN	89,6 / 93,1	78,8 / 81,6	75,8 / 78,3	67,2 / 69,1	
Rotation angle, bucket	°	179°	179°	179°	179°	
Max. recommended sizes for direct fit buckets						
GP-Bucket (1,5 t/m ³)	l	1 025	925	900	800	
GP-Bucket (1,8 t/m ³)	l	925	825	800	700	
Max. recommended sizes for quick fit buckets						
S6 QF GP-Bucket (1,5 t/m ³)	l	975	875	825	725	
S6 QF GP-Bucket (1,8 t/m ³)	l	850	775	725	650	
S1 QF GP-Bucket (1,5 t/m ³)	l	950	850	800	700	
S1 QF GP-Bucket (1,8 t/m ³)	l	825	750	700	625	
UQF GP-Bucket (1,5 t/m ³)	l	925	825	775	675	
UQF GP-Bucket (1,8 t/m ³)	l	800	725	675	600	

Note: 1. Bucket size based on SAE-J296, heaped material with a 1:1 angle of repose.
2. "Max permitted sizes" are for reference only and are not necessarily available from the factory.

Working ranges & digging forces

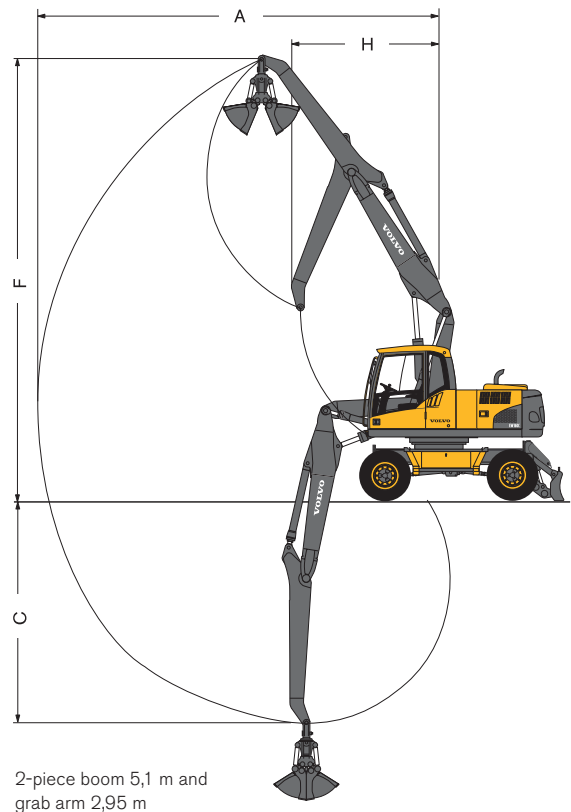
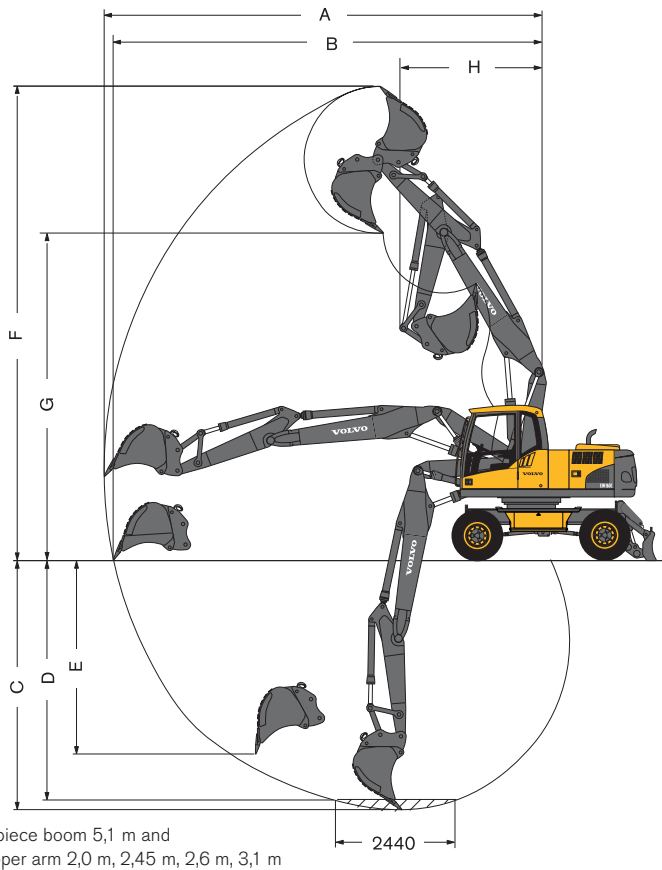

2-piece boom 5,1 m and
dipper arm 2,0 m, 2,45 m, 2,6 m, 3,1 m

2-piece boom 5,1 m and
grab arm 2,95 m

Description	Unit	5,1 m 2-piece boom				
		2,0 m arm	2,45 m arm	2,6 m arm	3,1 m arm	2,95 m Grab arm
A. Max. digging reach	mm	8 730	9 160	9 300	9 780	8 190
B. Max. digging reach on ground	mm	8 530	8 970	9 120	9 610	
C. Max. digging depth	mm	5 120	5 570	5 710	6 220	4 580
D. Max. digging depth (2 440 mm level)	mm	5 010	5 470	5 620	6 120	
E. Max. vertical wall digging depth	mm	3 970	4 440	4 590	5 070	
F. Max. cutting height	mm	9 670	10 000	10 110	10 480	9 000
G. Max. dumping height	mm	6 670	7 000	7 110	7 480	
H. Min. front slew radius	mm	2 690	2 820	2 860	3 000	3 010
Digging forces with direct fit bucket						
Bucket radius	mm	1 350	1 350	1 350	1 350	
Breakout force - bucket	(SAE/ISO) kN	108,0 / 122,7	108,0 / 122,7	108,0 / 122,7	108,0 / 122,7	
Tearout force	(SAE/ISO) kN	89,6 / 93,1	78,8 / 81,6	75,8 / 78,3	67,2 / 69,1	
Rotation angle, bucket	°	179°	179°	179°	179°	
Max. recommended sizes for direct fit buckets						
GP-Bucket (1,5 t/m ³)	l	1 000	900	850	775	
GP-Bucket (1,8 t/m ³)	l	875	775	750	675	
Max. recommended sizes for quick fit buckets						
S6 QF GP-Bucket (1,5 t/m ³)	l	925	825	800	700	
S6 QF GP-Bucket (1,8 t/m ³)	l	825	725	700	625	
S1 QF GP-Bucket (1,5 t/m ³)	l	900	800	775	675	
S1 QF GP-Bucket (1,8 t/m ³)	l	800	700	675	600	
UQF GP-Bucket (1,5 t/m ³)	l	875	775	750	650	
UQF GP-Bucket (1,8 t/m ³)	l	775	675	650	575	

Note: 1. Bucket size based on SAE-J296, heaped material with a 1:1 angle of repose.
2. "Max permitted sizes" are for reference only and are not necessarily available from the factory.

Working ranges & digging forces

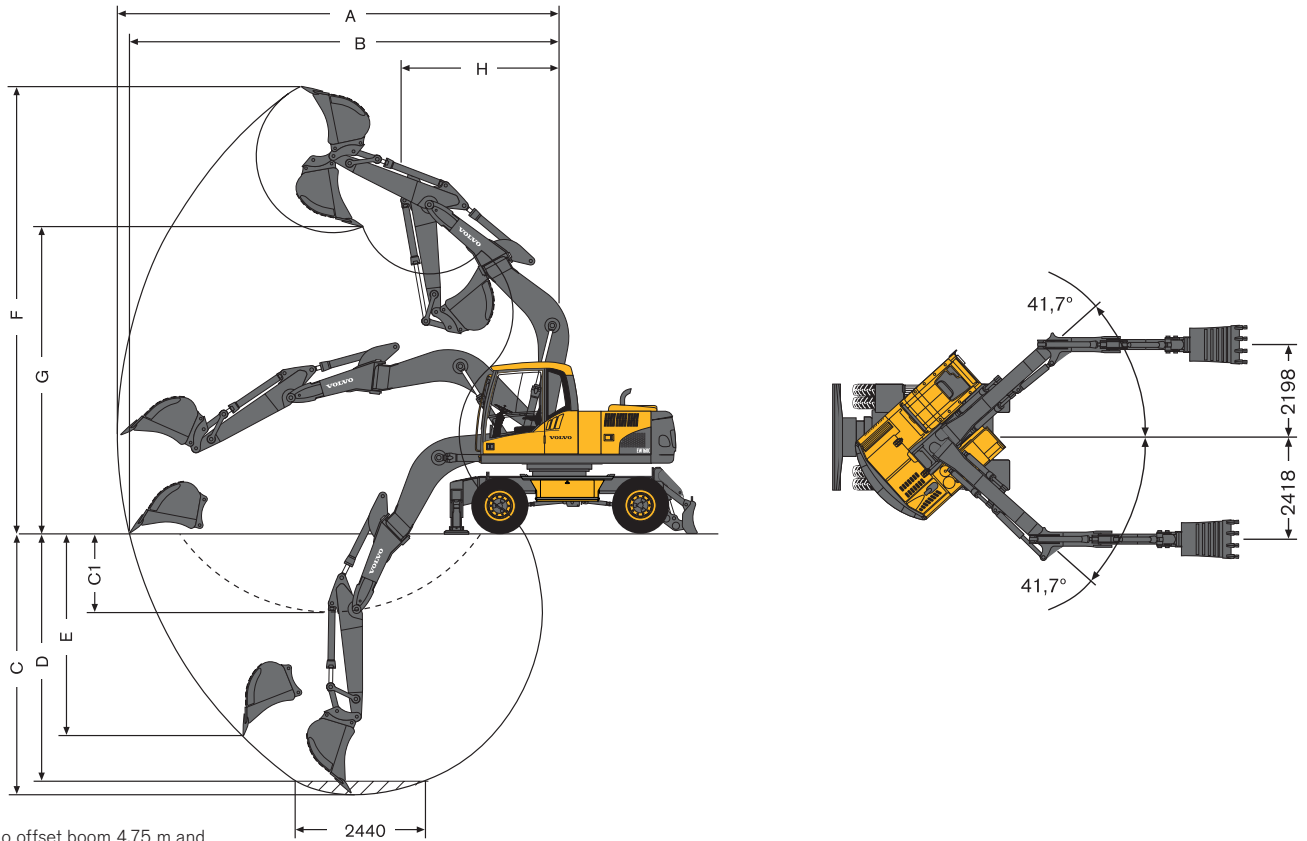

Mono offset boom 4,75 m and dipper arm 2,0 m, 2,45 m, 2,6 m, 3,1 m

Description	Unit	4,75 m Mono offset boom			
		2,0 m arm	2,45 m arm	2,6 m arm	3,1 m arm
A. Max. digging reach	mm	8 150	8 560	8 700	9 160
B. Max. digging reach on ground	mm	7 940	8 360	8 500	9 010
C. Max. digging depth	mm	4 840	5 290	5 440	5 940
C1. Max. digging depth at max. attachment offset with vertical trench walls	mm	1 470	1 920	2 070	2 570
D. Max. digging depth (2 440 mm level)	mm	4 590	5 070	5 230	5 760
E. Max. vertical wall digging depth	mm	3 790	4 190	4 330	4 810
F. Max. cutting height	mm	8 230	8 440	8 510	8 740
G. Max. dumping height	mm	5 650	5 860	5 920	6 150
H. Min. front slew radius	mm	2 940	2 920	2 910	2 960
Digging forces with direct fit bucket					
Bucket radius	mm	1 233	1 233	1 233	1 233
Breakout force - bucket	(SAE/ISO) kN	94,0 / 108,2	94,0 / 108,2	94,0 / 108,2	94,0 / 108,2
Tearout force	(SAE/ISO) kN	70,3 / 72,9	61,5 / 63,5	59,1 / 60,9	52,1 / 53,5
Rotation angle, bucket	°	177°	177°	177°	177°
Max. recommended sizes for direct fit buckets					
GP-Bucket (1,5 t/m³)	l	1 100	1 000	975	875
GP-Bucket (1,8 t/m³)	l	975	875	850	750
Max. recommended sizes for quick fit buckets					
S6 QF GP-Bucket (1,5 t/m³)	l	1 050	950	925	825
S6 QF GP-Bucket (1,8 t/m³)	l	925	825	800	725
UQF GP-Bucket (1,5 t/m³)	l	1 025	900	875	775
UQF GP-Bucket (1,8 t/m³)	l	900	800	775	675

Note: 1. Bucket size based on SAE-J296, heaped material with a 1:1 angle of repose.
2. "Max permitted sizes" are for reference only and are not necessarily available from the factory.

Working ranges & digging forces

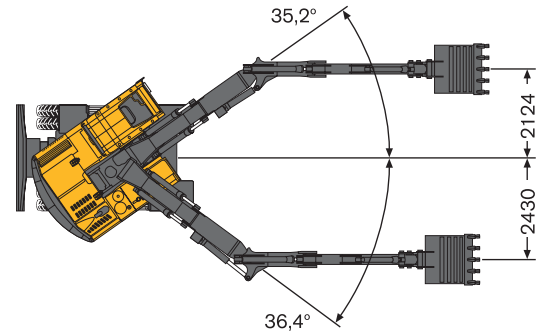
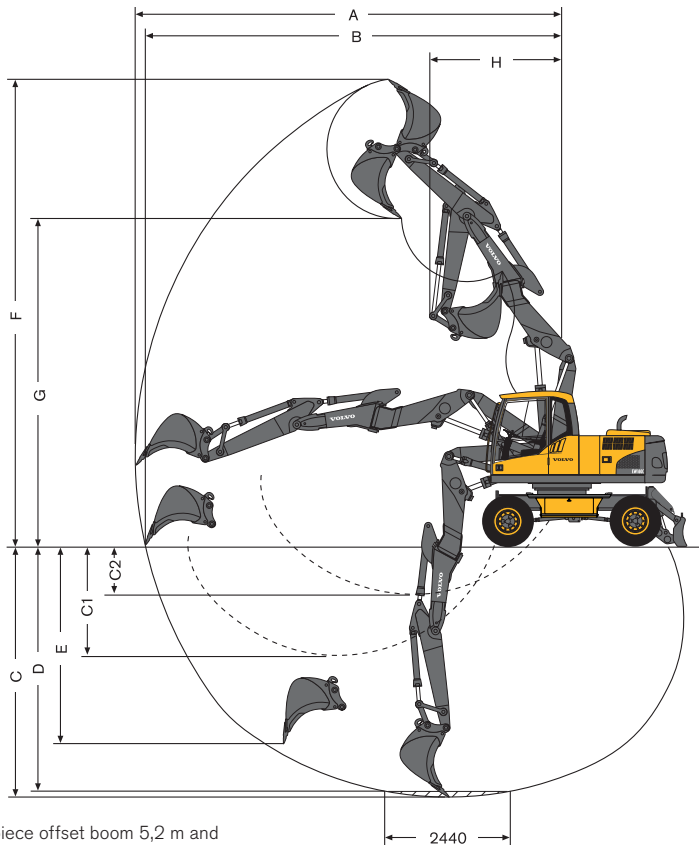

2-piece offset boom 5,2 m and dipper arm 2,0 m, 2,45 m, 2,6 m, 3,1 m









Description	Unit	5,2 m 2-piece offset boom			
		2,0 m arm	2,45 m arm	2,6 m arm	3,1 m arm
A. Max. digging reach	mm	8 740	9 170	9 310	9 790
B. Max. digging reach on ground	mm	8 550	8 980	9 130	9 610
C. Max. digging depth	mm	5 180	5 630	5 780	6 280
C1. Max. digging depth at max. attachment offset with vertical trench walls	mm	2 270	2 720	2 870	3 370
C2. Min. digging depth at max. attachment offset with vertical trench walls	mm	1 020	1 470	1 620	2 120
D. Max. digging depth (2 440 mm level)	mm	5 080	5 530	5 680	6 180
E. Max. vertical wall digging depth	mm	4 080	4 520	4 660	5 140
F. Max. cutting height	mm	9 570	9 880	9 980	10 330
G. Max. dumping height	mm	6 720	7 030	7 130	7 480
H. Min. front slew radius	mm	2 710	2 810	2 840	2 590
Digging forces with direct fit bucket					
Bucket radius	mm	1 233	1 233	1 233	1 233
Breakout force - bucket	(SAE/ISO) kN	94,0 / 108,2	94,0 / 108,2	94,0 / 108,2	94,0 / 108,2
Tearout force	(SAE/ISO) kN	70,3 / 72,9	61,5 / 63,5	59,1 / 60,9	52,1 / 53,5
Rotation angle, bucket	°	177°	177°	177°	177°
Max. recommended sizes for direct fit buckets					
GP-Bucket (1,5 t/m³)	l	925	825	800	700
GP-Bucket (1,8 t/m³)	l	800	725	700	625
Max. recommended sizes for quick fit buckets					
S6 QF GP-Bucket (1,5 t/m³)	l	875	775	750	650
S6 QF GP-Bucket (1,8 t/m³)	l	775	675	650	575
UQF GP-Bucket (1,5 t/m³)	l	825	750	725	625
UQF GP-Bucket (1,8 t/m³)	l	725	650	625	550

Note: 1. Bucket size based on SAE-J296, heaped material with a 1:1 angle of repose.
2. "Max permitted sizes" are for reference only and are not necessarily available from the factory.

Lifting capacity

At the arm end, without bucket and quick fit. Unit: 1000 kg.

For lifting capacity including bucket/quick fit, simply subtract actual weight of those parts from the following values.

 Across under-carriage  Along under-carriage	Arm end (bucket pivot) related to ground level	Reach from machine centre (u = support up/d = support down)														Max. m										
		1,5 m		3,0 m		4,5 m		6,0 m		7,5 m		Max. reach														
		u	d	u	d	u	d	u	d	u	d	u	d	u	d											
 5,0 m mono-block boom 2,0 m dipper arm Front dozer blade Rear outriggers	7,5 m																									
	6,0 m																		2,9	3,9*	3,9*	3,9*	5,7			
	4,5 m							4,1	5,1*	5,1*	5,1*	2,6	4,5	4,3	4,5*				2,3	3,7*	3,7	3,7*	6,5			
	3,0 m							3,8	6,3*	6,3*	6,3*	2,5	4,4	4,2	5,0*				2,0	3,5	3,3	3,7*	7,0			
	1,5 m							3,6	6,5	6,2	7,4*	2,4	4,3	4,0	5,5*				1,9	3,3	3,2	4,0*	7,1			
	0,0 m							3,4	6,4	6,0	7,9*	2,3	4,2	3,9	5,7*				2,0	3,5	3,3	4,6*	6,8			
	-1,5 m					6,2	10,9*	10,9*	10,9*	3,4	6,4	6,0	7,6*	2,3	4,2	3,9	5,5*			2,2	4,0	3,8	5,2*	6,2		
	-3,0 m					6,4	9,0*	9,0*	9,0*	3,5	6,3*	6,1	6,3*							3,0	5,2*	5,1	5,2*	5,1		
	-4,5 m																									
 5,0 m mono-block boom 2,45 m dipper arm Front dozer blade Rear outriggers	7,5 m																									
	6,0 m											2,7	3,9*	3,9*	3,9*											
	4,5 m							4,2	4,6*	4,6*	4,6*	2,7	4,1*	4,1*	4,1*											
	3,0 m							3,9	5,8*	5,8*	5,8*	2,5	4,4	4,2	4,7*											
	1,5 m							3,6	6,6	6,2	7,0*	2,4	4,2	4,0	5,2*	1,7	3,0	2,9	3,2*							
	0,0 m					5,8*	5,8*	5,8*	5,8*	3,4	6,3	6,0	7,7*	2,3	4,1	3,9	5,6*									
	-1,5 m	6,0*	6,0*	6,0*	6,0*	6,1	10,6*	10,6*	10,6*	3,3	6,3	5,9	7,7*	2,3	4,1	3,9	5,6*									
	-3,0 m					6,2	9,8*	9,8*	9,8*	3,4	6,4	6,0	6,8*													
	-4,5 m																									
 5,0 m mono-block boom 2,6 m dipper arm Front dozer blade Rear outriggers	7,5 m																									
	6,0 m											2,7	3,9*	3,9*	3,9*											
	4,5 m							4,2	4,4*	4,4*	4,4*	2,7	4,0*	4,0*	4,0*											
	3,0 m							3,9	5,6*	5,6*	5,6*	2,5	4,4	4,2	4,5*	1,8	3,1	2,9	3,2*							
	1,5 m							3,6	6,6	6,2	6,9*	2,4	4,2	4,0	5,1*	1,7	3,0	2,9	4,0*							
	0,0 m					6,0*	6,0*	6,0*	6,0*	3,4	6,3	6,0	7,6*	2,3	4,1	3,9	5,6*									
	-1,5 m	5,8*	5,8*	5,8*	5,8*	6,0	10,2*	10,2*	10,2*	3,3	6,3	5,9	7,7*	2,2	4,1	3,8	5,6*									
	-3,0 m					6,2	10,1*	10,1*	10,1*	3,4	6,3	6,0	6,9*													
	-4,5 m																									
 5,0 m mono-block boom 3,1 m dipper arm Front dozer blade Rear outriggers	7,5 m																									
	6,0 m											2,8	3,4*	3,4*	3,4*											
	4,5 m											2,7	3,6*	3,6*	3,6*	1,8	2,8*	2,8*	2,8*							
	3,0 m					7,3	7,4*	7,4*	7,4*	4,0	5,1*	5,1*	5,1*	2,6	4,2*	4,2	4,2*	1,8	3,1	2,9	3,8*	1,6	2,2*	2,2*	2,2*	8,0
	1,5 m									3,6	6,5*	6,3	6,5*	2,4	4,2	4,0	4,9*	1,7	3,0	2,9	4,1*	1,5	2,3*	2,3*	2,3*	8,1
	0,0 m					6,0	6,4*	6,4*	6,4*	3,4	6,3	6,0	7,4*	2,3	4,1	3,9	5,4*	1,6	3,0	2,8	4,3*	1,5	2,6*	2,6*	2,6*	7,9
	-1,5 m	5,2*	5,2*	5,2*	5,2*	5,9	9,3*	9,3*	9,3*	3,3	6,2	5,9	7,7*	2,2	4,0	3,8	5,6*									
	-3,0 m	8,7*	8,7*	8,7*	8,7*	6,0	10,8*	10,8*	10,8*	3,3	6,2	5,9	7,2*	2,2	4,1	3,8	5,2*									
	-4,5 m					6,3	8,2*	8,2*	8,2*	3,5	5,4*	5,4*	5,4*													
 5,0 m mono-block boom 2,95 m dipper arm for grab Front dozer blade Rear outriggers	7,5 m																									
	6,0 m											3,0	3,8*	3,8*	3,8*											
	4,5 m											3,0	4,1*	4,1*	4,1*	2,1	3,0*	3,0*	3,0*							
	3,0 m								4,2	5,6*	5,6*	5,6*	2,8	4,7*	4,5	4,7*	2,1	3,4	3,2	4,2*	1,9	2,6*	2,6*	2,6*	8,0	
	1,5 m								4,0	7,0	6,6	7,0*	2,7	4,6	4,3	5,3*	2,0	3,3	3,2	4,5*	1,8	2,7*	2,7*	2,7*	8,0	
	0,0 m					5,9*	5,9*	5,9*	5,9*	3,8	6,7	6,4	7,9*	2,6	4,4	4,2	5,8*	2,0	3,3	3,1	4,7*	1,8	3,0*	2,9	3,0*	7,8
	-1,5 m	5,1*	5,1*	5,1*	5,1*	6,5	9,3*	9,3*	9,3*	3,7	6,6	6,3	8,1*	2,5	4,4	4,2	6,0*									
	-3,0 m	9,0*	9,0*	9,0*	9,0*	6,5	11,1*	11,1*	11,1*	3,7	6,7	6,3	7,6*	2,6	4,4	4,2	5,4*									
	-4,5 m									3,8	5,4*	5,4*	5,4*													
 5,0 m monoblock boom 2,0 m dipper arm Front and rear outriggers	7,5 m																									
	6,0 m																									
	4,5 m								4,1	5,1*	5,1*	5,1*	2,7	4,5*	4,3	4,5*										
	3,0 m								3,9	6,3*	6,3*	6,3*	2,6	5,0*	4,1	5,0*										
	1,5 m								3,6	7,4*	6,1	7,4*	2,4	5,3	4,0	5,5*										
	0,0 m								3,5	7,9*	6,0	7,9*	2,4	5,2	3,9	5,7*										
	-1,5 m					6,3	10,9*	10,9*	10,9*	3,5	7,6*	6,0	7,6*	2,4	5,2	3,9	5,5*									
	-3,0 m					6,4	9,0*	9,0*	9,0*	3,6	6,3*	6,1	6,3*													
	-4,5 m																									

Notes: 1. Working pressure with Power Boost = 36 MPa.









2. The above values are in compliance with ISO standard 10 567. They do not exceed 87 % of hydraulic lifting capacity or 75 % of tipping load, with the machine on firm, level ground.

3. Load capacities marked with an asterisk (*) are limited by machine's hydraulic lifting capacity rather than tipping load.

Lifting capacity

At the arm end, without bucket and quick fit. Unit: 1000 kg.

For lifting capacity including bucket/quick fit, simply subtract actual weight of those parts from the following values.









 Across under-carriage  Along under-carriage	Arm end (bucket pivot) related to ground level	Reach from machine centre (u = support up/d = support down)																					
		1,5 m		3,0 m		4,5 m		6,0 m		7,5 m		Max. reach											
		u	d	u	d	u	d	u	d	u	d	u	d	u	d	u	d	Max. m					
 5,0 m monoblock boom 2,45 m dipper arm Front and rear outriggers	7,5 m																3,6*	3,6*	3,6*	3,6*	4,8		
	6,0 m								2,7	3,9*	3,9*	3,9*					2,6	3,1*	3,1*	3,1*	6,2		
	4,5 m								4,2	4,6*	4,6*	4,6*	2,7	4,1*	4,1*	4,1*	2,1	2,9*	2,9*	2,9*	7,0		
	3,0 m								3,9	5,8*	5,8*	5,8*	2,6	4,7*	4,1	4,7*	1,8	3,0*	3,0*	3,0*	7,4		
	1,5 m								3,6	7,0*	6,2	7,0*	2,4	5,2*	4,0	5,2*	1,7	3,2*	2,9	3,2*	7,5		
	0,0 m								5,8*	5,8*	5,8*	5,8*	3,4	7,7*	6,0	7,7*	2,3	5,2	3,9	5,6*	7,3		
	-1,5 m	6,0*	6,0*	6,0*	6,0*	6,1	10,6*	10,6*	10,6*	10,6*	3,4	7,7*	5,9	7,7*	2,3	5,1	3,9	5,6*			6,7		
	-3,0 m					6,3	9,8*	9,8*	9,8*	3,4	6,8*	6,0	6,8*								5,7		
	-4,5 m																						
 5,0 m monoblock boom 2,6 m dipper arm Front and rear outriggers	7,5 m																3,3*	3,3*	3,3*	3,3*	5,0		
	6,0 m									2,7	3,9*	3,9*	3,9*				2,5	2,9*	2,9*	2,9*	6,4		
	4,5 m								4,2	4,4*	4,4*	4,4*	2,7	4,0*	4,0*	4,0*	2,0	2,7*	2,7*	2,7*	7,2		
	3,0 m								3,9	5,6*	5,6*	5,6*	2,6	4,5*	4,1	4,5*	1,8	3,2*	2,9	3,2*	7,6		
	1,5 m								3,6	6,9*	6,2	6,9*	2,4	5,1*	4,0	5,1*	1,7	3,8	2,9	4,0*	7,6		
	0,0 m					6,0*	6,0*	6,0*	6,0*	3,4	7,6*	5,9	7,6*	2,3	5,2	3,9	5,6*	1,7	3,3*	2,8	3,3*	7,4	
	-1,5 m	5,8*	5,8*	5,8*	5,8*	6,1	10,2*	10,2*	10,2*	3,3	7,7*	5,9	7,7*	2,3	5,1	3,8	5,6*	1,9	4,0*	3,2	4,0*	6,9	
	-3,0 m					6,2	10,1*	10,1*	10,1*	3,4	6,9*	5,9	6,9*					2,4	4,9*	4,0	4,9*	5,9	
	-4,5 m																						
 5,0 m monoblock boom 3,1 m dipper arm Front and rear outriggers	7,5 m																2,6*	2,6*	2,6*	2,6*	5,7		
	6,0 m										2,8	3,4*	3,4*	3,4*			2,1	2,3*	2,3*	2,3*	6,9		
	4,5 m										2,7	3,6*	3,6*	3,6*	1,8	2,8*	2,8*	2,8*	1,8	2,2*	2,2*	2,2*	7,7
	3,0 m					7,4	7,4*	7,4*	7,4*	4,0	5,1*	5,1*	5,1*	2,6	4,2*	4,2	4,2*	1,8	3,8*	2,9	3,8*	8,0	
	1,5 m									3,6	6,5*	6,2	6,5*	2,4	4,9*	4,0	4,9*	1,7	3,8	2,8	4,1*	8,1	
	0,0 m					6,1	6,4*	6,4*	6,4*	3,4	7,4*	6,0	7,4*	2,3	5,2	3,9	5,4*	1,7	3,7	2,8	4,3*	7,9	
	-1,5 m	5,2*	5,2*	5,2*	5,2*	6,0	9,3*	9,3*	9,3*	3,3	7,7*	5,8	7,7*	2,2	5,1	3,8	5,6*	1,7	3,0*	2,8	3,0*	7,4	
	-3,0 m	8,7*	8,7*	8,7*	8,7*	6,1	10,8*	10,8*	10,8*	3,3	7,2*	5,9	7,2*	2,2	5,1	3,8	5,2*	2,0	4,0*	3,4	4,0*	6,5	
	-4,5 m					6,3	8,2*	8,2*	8,2*	3,5	5,4*	5,4	5,4*					3,1	4,6*	4,6	4,6*	4,9	
 5,0 m monoblock boom 2,95 m dipper arm for grab Front and rear outriggers	7,5 m																3,1*	3,1*	3,1*	3,1*	5,6		
	6,0 m										3,0	3,8*	3,8*	3,8*			2,5	2,7*	2,7*	2,7*	6,8		
	4,5 m										3,0	4,1*	4,1*	4,1*	2,1	3,0*	3,0*	3,0*	2,1	2,6*	2,6*	2,6*	7,6
	3,0 m									4,3	5,6*	5,6*	5,6*	2,9	4,7*	4,5	4,7*	2,1	4,1	3,2	4,2*	8,0	
	1,5 m									4,0	7,0*	6,6	7,0*	2,7	5,3*	4,3	5,3*	2,0	4,1	3,1	4,5*	8,0	
	0,0 m					5,9*	5,9*	5,9*	5,9*	3,8	7,9*	6,3	7,9*	2,6	5,5	4,2	5,8*	2,0	4,0	3,1	4,7*	7,8	
	-1,5 m	5,1*	5,1*	5,1*	5,1*	6,5	9,3*	9,3*	9,3*	3,7	8,1*	6,2	8,1*	2,6	5,4	4,1	6,0*	2,0	3,4*	3,2	3,4*	7,3	
	-3,0 m	9,0*	9,0*	9,0*	9,0*	6,6	11,1*	11,1*	11,1*	3,7	7,6*	6,3	7,6*	2,6	5,4*	4,2	5,4*	2,4	4,4*	3,8	4,4*	6,4	
	-4,5 m									3,9	5,4*	5,4*	5,4*					3,8	5,3*	5,3*	5,3*	4,6	
 5,0 m monoblock boom 2,0 m dipper arm Rear dozer blade	7,5 m																						
	6,0 m																	2,8	3,1	3,9*	3,9*	5,7	
	4,5 m									3,9	4,5	5,1*	5,1*	2,5	2,8	4,3	4,5*	2,1	2,4	3,7	3,7*	6,5	
	3,0 m									3,6	4,1	6,3*	6,3*	2,4	2,7	4,1	5,0*	1,9	2,1	3,3	3,7*	7,0	
	1,5 m									3,3	3,9	6,1	7,4*	2,3	2,6	4,0	5,5*	1,8	2,1	3,1	4,0*	7,1	
	0,0 m									3,2	3,7	6,0	7,9*	2,2	2,5	3,9	5,7*	1,8	2,1	3,3	4,6*	6,8	
	-1,5 m					5,8	6,9	10,9*	10,9*	3,2	3,7	6,0	7,6*	2,2	2,5	3,9	5,5*	2,1	2,4	3,7	5,2*	6,2	
	-3,0 m					6,0	7,1	9,0*	9,0*	3,3	3,8	6,1	6,3*					2,8	3,3	5,1	5,2*	5,1	
	-4,5 m																						
 5,0 m monoblock boom 2,45 m dipper arm Rear dozer blade	7,5 m																3,6*	3,6*	3,6*	3,6*	4,8		
	6,0 m													2,5	2,9	3,9*	3,9*	2,4	2,7	3,1*	3,1*	6,2	
	4,5 m									3,9	4,5	4,6*	4,6*	2,5	2,9	4,1*	4,1*	1,9	2,2	2,9*	2,9*	7,0	
	3,0 m									3,6	4,2	5,8*	5,8*	2,4	2,7	4,1	4,7*	1,7	1,9	3,0*	3,0*	7,4	
	1,5 m									3,3	3,9	6,2	7,0*	2,2	2,6	4,0	5,2*	1,6	1,9	2,9	3,1*	7,5	
	0,0 m					5,7	5,8*	5,8*	5,8*	3,2	3,7	6,0	7,7*	2,1	2,5	3,9	5,6*	1,6	1,9	2,9	3,5*	7,3	
	-1,5 m	6,0*	6,0*	6,0*	6,0*	5,7	6,8	10,6*	10,6*	3,1	3,7	5,9	7,7*	2,1	2,5	3,9	5,6*	1,8	2,1	3,3	4,3*	6,7	
	-3,0 m					5,8	7,0	9,8*	9,8*	3,2	3,7	6,0	6,8*					2,3	2,7	4,3	5,0*	5,7	
	-4,5 m																						

- Notes:
1. Working pressure with Power Boost = 36 MPa.
 2. The above values are in compliance with ISO standard 10 567. They do not exceed 87 % of hydraulic lifting capacity or 75 % of tipping load, with the machine on firm, level ground.
 3. Load capacities marked with an asterisk (*) are limited by machine's hydraulic lifting capacity rather than tipping load.

Lifting capacity

At the arm end, without bucket and quick fit. Unit: 1000 kg.

For lifting capacity including bucket/quick fit, simply subtract actual weight of those parts from the following values.







 Across under-carriage  Along under-carriage	Arm end (bucket pivot) related to ground level	Reach from machine centre (u = support up / d = support down)																															
		1,5 m		3,0 m		4,5 m		6,0 m		7,5 m		Max. reach																					
		u	d	u	d	u	d	u	d	u	d	u	d	u	d	u	d	Max. m															
 5,0 m monoblock boom 2,6 m dipper arm Rear dozer blade	7,5 m																	3,3*	3,3*	3,3*	3,3*	5,0											
	6,0 m								2,6	2,9	3,9*	3,9*						2,3	2,6	2,9*	2,9*	6,4											
	4,5 m							4,0	4,4*	4,4*	4,4*	2,5	2,9	4,0*	4,0*			1,8	2,1	2,7*	2,7*	7,2											
	3,0 m							3,6	4,2	5,6*	5,6*	2,4	2,7	4,1	4,5*	1,6	1,9	2,9	3,2*	1,6	1,9	2,8*	2,8*	7,6									
	1,5 m							3,3	3,9	6,2	6,9*	2,2	2,6	4,0	5,1*	1,6	1,8	2,9	4,0*	1,5	1,8	2,8	2,9*	7,6									
	0,0 m					5,6	6,0*	6,0*	6,0*	3,1	3,7	5,9	7,6*	2,1	2,5	3,9	5,6*			1,6	1,8	2,8	3,3*	7,4									
	-1,5 m	5,8*	5,8*	5,8*	5,8*	5,6	6,8	10,2*	10,2*	3,1	3,6	5,9	7,7*	2,1	2,4	3,8	5,6*			1,7	2,0	3,2	4,0*	6,9									
	-3,0 m					5,8	6,9	10,1*	10,1*	3,1	3,7	5,9	6,9*							2,2	2,6	4,0	4,9*	5,9									
	-4,5 m																																
 5,0 m monoblock boom 3,1 m dipper arm Rear dozer blade	7,5 m																	2,6*	2,6*	2,6*	2,6*	5,7											
	6,0 m									2,6	3,0	3,4*	3,4*					2,0	2,3	2,3*	2,3*	6,9											
	4,5 m									2,5	2,9	3,6*	3,6*	1,7	2,0	2,8*	2,8*	1,6	1,9	2,2*	2,2*	7,7											
	3,0 m					6,9	7,4*	7,4*	7,4*	3,7	4,3	5,1*	5,1*	2,4	2,8	4,2	4,2*	1,7	1,9	2,9	3,8*	1,4	1,7	2,2*	2,2*	8,0							
	1,5 m								3,4	3,9	6,2	6,5*	2,2	2,6	4,0	4,9*	1,6	1,8	2,8	4,1	1,4	1,6	2,3*	2,3*	8,1								
	0,0 m					5,6	6,4*	6,4*	6,4*	3,1	3,7	6,0	7,4*	2,1	2,5	3,9	5,4*	1,5	1,8	2,8	4,0	1,4	1,6	2,6	2,6*	7,9							
	-1,5 m	5,2*	5,2*	5,2*	5,2*	5,6	6,7	9,3*	9,3*	3,0	3,6	5,8	7,7*	2,0	2,4	3,8	5,6*			1,5	1,8	2,8	3,0*	7,4									
	-3,0 m	8,7*	8,7*	8,7*	8,7*	5,6	6,8	10,8*	10,8*	3,1	3,6	5,9	7,2*	2,1	2,4	3,8	5,2*			1,9	2,2	3,4	4,0*	6,5									
	-4,5 m					5,9	7,0	8,2*	8,2*	3,2	3,8	5,4*	5,4*							2,9	3,3	4,6*	4,6*	4,9									
 5,0 m monoblock boom 2,95 m dipper arm for grab Rear dozer blade	7,5 m																											3,1*	3,1*	3,1*	3,1*	5,6	
	6,0 m													2,9	3,2	3,8*	3,8*			2,3	2,6	2,7*	2,7*	6,8									
	4,5 m													2,8	3,2	4,1*	4,1*	2,0	2,2	3,0*	3,0*	1,9	2,2	2,6*	2,6*	7,6							
	3,0 m								4,0	4,6	5,6*	5,6*	2,7	3,0	4,5	4,7*	1,9	2,2	3,2	4,2*	1,8	2,0	2,6*	2,6*	8,0								
	1,5 m								3,7	4,3	6,6	7,0*	2,6	2,9	4,3	5,3*	1,9	2,1	3,1	4,4	1,7	1,9	2,7*	2,7*	8,0								
	0,0 m					5,9*	5,9*	5,9*	5,9*	3,5	4,1	6,3	7,9*	2,4	2,8	4,2	5,8*	1,8	2,1	3,1	4,3	1,7	2,0	2,9	3,0*	7,8							
	-1,5 m	5,1*	5,1*	5,1*	5,1*	6,1	7,2	9,3*	9,3*	3,4	4,0	6,2	8,1*	2,4	2,7	4,1	6,0			1,9	2,1	3,2	3,4*	7,3									
	-3,0 m	9,0*	9,0*	9,0*	9,0*	6,2	7,3	11,1*	11,1*	3,5	4,0	6,3	7,6*	2,4	2,8	4,2	5,4*			2,3	2,6	3,8	4,4*	6,4									
	-4,5 m									3,6	4,2	5,4*	5,4*							3,6	4,1	5,3*	5,3*	4,6									
 5,1 m 2-piece boom 2,0 m dipper arm Front dozer blade Rear outriggers	7,5 m																																
	6,0 m																																
	4,5 m								4,3	4,6*	4,6*	4,6*																					
	3,0 m					7,1*	7,1*	7,1*	7,1*	4,1	5,3*	5,3*	5,3*	2,6	4,5	4,3	4,6*					2,2	3,8	3,6	4,1*	6,7							
	1,5 m								3,8	6,5*	6,5*	6,5*	2,5	4,4	4,2	5,0*					1,9	3,4	3,2	4,1*	7,1								
	0,0 m								3,5	6,5	6,2	7,5*	2,4	4,2	4,0	5,5*					1,8	3,2	3,1	4,3*	7,2								
	-1,5 m								3,4	6,4	6,0	7,8*	2,3	4,2	3,9	5,7*					1,9	3,4	3,2	4,7*	7,0								
	-3,0 m					6,2	10,1*	10,1*	10,1*	3,4	6,4	6,0	7,3*	2,3	4,2	3,9	5,3*				2,1	3,8	3,6	4,8*	6,4								
	-4,5 m																																
 5,1 m 2-piece boom 2,45 m dipper arm Front dozer blade Rear outriggers	7,5 m								4,3*	4,3*	4,3*	4,3*																					
	6,0 m								4,1*	4,1*	4,1*	4,1*	2,7	4,1*	4,1*	4,1*					2,4	3,4*	3,4*	3,4*	6,4								
	4,5 m					6,1*	6,1*	6,1*	6,1*	4,2	4,8*	4,8*	4,8*	2,6	4,3*	4,3*	4,3*					1,9	3,2*	3,2	3,2*	7,2							
	3,0 m								3,8	6,0*	6,0*	6,0*	2,5	4,4	4,2	4,8*	1,8	3,1	2,9	3,7*	1,7	3,1	2,9	3,2*	7,6								
	1,5 m								3,5	6,5	6,2	7,2*	2,4	4,2	4,0	5,3*	1,7	3,0	2,9	4,4*	1,6	3,0	2,8	3,4*	7,6								
	0,0 m								3,3	6,3	6,0	7,7*	2,3	4,1	3,9	5,6*					1,7	3,0	2,9	3,8*	7,4								
	-1,5 m					6,0	9,1*	9,1*	9,1*	3,3	6,3	5,9	7,5*	2,2	4,1	3,9	5,5*				1,9	3,4	3,2	4,5*	6,9								
	-3,0 m									3,4	6,4	6,0	6,5*								2,6	4,8	4,5	5,1*	5,4								
	-4,5 m																																
 5,1 m 2-piece boom 2,6 m dipper arm Front dozer blade Rear outriggers	7,5 m								4,1*	4,1*	4,1*	4,1*																					
	6,0 m								4,0*	4,0*	4,0*	4,0*	2,7	4,0*	4,0*	4,0*					2,3	3,2*	3,2*	3,2*	6,5								
	4,5 m								4,2	4,7*	4,7*	4,7*	2,6	4,1*	4,1*	4,1*					1,9	3,0*	3,0*	3,0*	7,3								
	3,0 m								3,8	5,9*	5,9*	5,9*	2,5	4,4	4,2	4,7*	1,7	3,1	2,9	4,1*	1,7	3,0	2,8	3,0*	7,7								
	1,5 m								3,5	6,5	6,2	7,0*	2,4	4,2	4,0	5,2*	1,7	3,0	2,9	4,3*	1,6	2,9	2,7	3,2*	7,8								
	0,0 m					4,6*	4,6*	4,6*	4,6*	3,3	6,3	6,0	7,6*	2,2	4,1	3,9	5,5*	1,6	3,0	2,8	4,2*	1,6	2,9	2,8	3,5*	7,6							
	-1,5 m					6,0	8,8*	8,8*	8,8*	3,3	6,3	5,9	7,5*	2,2	4,1	3,8	5,5*				1,8	3,3	3,1	4,1*	7,0								
	-3,0 m									3,3	6,3	6,0	6,6*								2,4	4,3	4,1	4,7*	5,8								
	-4,5 m																																

- Notes: 1. Working pressure with Power Boost = 36 MPa.
 2. The above values are in compliance with ISO standard 10 567. They do not exceed 87 % of hydraulic lifting capacity or 75 % of tipping load, with the machine on firm, level ground.
 3. Load capacities marked with an asterisk (*) are limited by machine's hydraulic lifting capacity rather than tipping load.

Lifting capacity

At the arm end, without bucket and quick fit. Unit: 1000 kg.

For lifting capacity including bucket/quick fit, simply subtract actual weight of those parts from the following values.









 Across under-carriage	Arm end (bucket pivot) related to ground level	Reach from machine centre (u = support up/d = support down)																													
		1,5 m		3,0 m		4,5 m		6,0 m		7,5 m		Max. reach																			
		u	d	u	d	u	d	u	d	u	d	u	d	u	d	Max. m															
 5,1 m 2-piece boom 3,1 m dipper arm Front dozer blade Rear outriggers	7,5 m														2,8	2,8*	2,8*	2,8*	5,9												
	6,0 m								2,8	3,5*	3,5*	3,5*				2,0	2,5*	2,5*	2,5*	7,1											
	4,5 m								4,1*	4,1*	4,1*	4,1*	2,7	3,8*	3,8*	3,8*	1,8	3,2	3,0	3,4*	1,7	2,4*	2,4*	2,4*	7,8						
	3,0 m								3,9	5,3*	5,3*	5,3*	2,5	4,3*	4,2	4,3*	1,8	3,1	2,9	3,9*	1,5	2,4*	2,4*	2,4*	8,2						
	1,5 m								3,6	6,6	6,2	6,6*	2,4	4,2	4,0	5,0*	1,7	3,0	2,9	4,1*	1,4	2,5*	2,5	2,5*	8,3						
	0,0 m								5,1*	5,1*	5,1*	5,1*	3,3	6,3	6,0	7,4*	2,2	4,1	3,9	5,4*	1,6	3,0	2,8	4,3*	1,5	2,7	2,5	2,8*	8,1		
	-1,5 m								5,9	8,0*	8,0*	8,0*	3,2	6,2	5,9	7,6*	2,2	4,0	3,8	5,5*	1,6	2,9	2,8	3,7*	1,6	2,9	2,7	3,2*	7,6		
	-3,0 m								6,0	10,2*	10,2*	10,2*	3,3	6,3	5,9	7,0*	2,2	4,1	3,8	5,0*					1,9	3,5	3,3	4,1*	6,7		
	-4,5 m																														
 5,1 m 2-piece boom 2,95 m dipper arm for grab Front dozer blade Rear outriggers	7,5 m																														
	6,0 m													3,0	4,0*	4,0*	4,0*									3,1	3,4*	3,4*	3,4*	5,4	
	4,5 m													4,5	4,6*	4,6*	4,6*	3,0	4,2*	4,2*	4,2*	2,1	3,4	3,3	3,8*	2,0	2,9*	2,9*	2,9*	7,7	
	3,0 m													4,2	5,9*	5,9*	5,9*	2,8	4,7	4,5	4,8*	2,0	3,4	3,2	4,3*	1,8	2,8*	2,8*	2,8*	8,1	
	1,5 m													3,9	7,0	6,6	7,2*	2,7	4,6	4,3	5,4*	2,0	3,3	3,2	4,5*	1,8	2,9	2,8	2,9*	8,2	
	0,0 m													3,7	6,7	6,4	7,9*	2,6	4,4	4,2	5,8*	1,9	3,3	3,3	4,7*	1,8	3,0	2,9	3,2*	8,0	
	-1,5 m													6,4	7,9*	7,9*	7,9*	3,6	6,6	6,3	8,0*	2,5	4,4	4,2	5,9*		1,9	3,3	3,1	3,6*	7,5
	-3,0 m													6,5	10,5*	10,5*	10,5*	3,7	6,7	6,3	7,3*	2,5	4,4	4,2	5,3*		2,3	4,0	3,8	4,5*	6,5
	-4,5 m																														
 5,1 m 2-piece boom 2,0 m dipper arm Front and rear outriggers	7,5 m																														
	6,0 m																														
	4,5 m																														
	3,0 m																														
	1,5 m																														
	0,0 m																														
	-1,5 m																														
	-3,0 m																														
	-4,5 m																														
 5,1 m 2-piece boom 2,45 m dipper arm Front and rear outrigger	7,5 m																														
	6,0 m																														
	4,5 m																														
	3,0 m																														
	1,5 m																														
	0,0 m																														
	-1,5 m																														
	-3,0 m																														
	-4,5 m																														
 5,1 m 2-piece boom 2,6 m dipper arm Front and rear outriggers	7,5 m																														
	6,0 m																														
	4,5 m																														
	3,0 m																														
	1,5 m																														
	0,0 m																														
	-1,5 m																														
	-3,0 m																														
	-4,5 m																														
 5,1 m 2-piece boom 3,1 m dipper arm Front and rear outriggers	7,5 m																														
	6,0 m																														
	4,5 m																														
	3,0 m																														
	1,5 m																														
	0,0 m																														
	-1,5 m																														
	-3,0 m																														
	-4,5 m																														

- Notes:
1. Working pressure with Power Boost = 36 MPa.
 2. The above values are in compliance with ISO standard 10 567. They do not exceed 87 % of hydraulic lifting capacity or 75 % of tipping load, with the machine on firm, level ground.
 3. Load capacities marked with an asterisk (*) are limited by machine's hydraulic lifting capacity rather than tipping load.

Lifting capacity

At the arm end, without bucket and quick fit. Unit: 1000 kg.

For lifting capacity including bucket/quick fit, simply subtract actual weight of those parts from the following values.

 Across under-carriage  Along under-carriage	Arm end (bucket pivot) related to ground level	Reach from machine centre (u = support up/d = support down)																															
		1,5 m		3,0 m				4,5 m				6,0 m				7,5 m				Max. reach													
		u	d	u	d	u	d	u	d	u	d	u	d	u	d	u	d	u	d	u	d	u	d	u	d	Max. m							
 5,1 m 2-piece boom 2,95 m dipper arm for grab Front and rear outriggers	7,5 m																							3,1	3,4*	3,4*	3,4*	5,8					
	6,0 m													3,0	4,0*	4,0*	4,0*								2,4	3,0*	3,0*	3,0*	6,8				
	4,5 m								4,5	4,6*	4,6*	4,6*	3,0	4,2*	4,2*	4,2*	2,1	3,8*	3,3	3,8*				2,0	2,9*	2,9*	2,9*	7,7					
	3,0 m								4,3	5,9*	5,9*	5,9*	2,9	4,8*	4,5	4,8*	2,1	4,1	3,2	4,3*				1,8	2,8*	2,8*	2,8*	8,1					
	1,5 m								3,9	7,2*	6,6	7,2*	2,7	5,4*	4,3	5,4*	2,0	4,1	3,1	4,5*				1,8	2,9*	2,8	2,9*	8,2					
	0,0 m								3,7	7,9*	6,3	7,9*	2,6	5,5	4,2	5,8*	2,0	4,0	3,1	4,7*				1,8	3,2*	2,8	3,2*	8,0					
	-1,5 m					6,5	7,9*	7,9*	7,9*	3,7	8,0*	6,2	8,0*	2,5	5,4	4,1	5,9*								2,0	3,6*	3,1	3,6*	7,5				
	-3,0 m					6,6	10,5*	10,5*	10,5*	3,7	7,3*	6,3	7,3*	2,6	5,3*	4,2	5,3*								2,3	4,5*	3,7	4,5*	6,5				
-4,5 m																																	
 5,1 m 2-piece boom 2,0 m dipper arm Rear dozer blade	7,5 m																									4,3	4,9	5,1*	5,1*	4,3			
	6,0 m								4,1	4,6*	4,6*	4,6*													2,6	3,0	4,3*	4,3*	5,8				
	4,5 m								3,9	4,4	5,3*	5,3*	2,5	2,8	4,3	4,6*								2,0	2,3	3,6	4,1*	6,7					
	3,0 m								3,6	4,1	6,5	6,5*	2,3	2,7	4,1	5,0*								1,8	2,1	3,2	4,1*	7,1					
	1,5 m								3,3	3,8	6,1	7,5*	2,2	2,6	4,0	5,5*								1,7	2,0	3,1	4,3*	7,2					
	0,0 m								3,2	3,7	6,0	7,8*	2,1	2,5	3,9	5,7*								1,8	2,0	3,2	4,6	7,0					
	-1,5 m								5,8	6,9	10,1*	10,1*	3,2	3,7	6,0	7,3*	2,1	2,5	3,9	5,3*				2,0	2,3	3,6	4,8*	6,4					
	-3,0 m																																
-4,5 m																																	
 5,1 m 2-piece boom 2,45 m dipper arm Rear dozer blade	7,5 m																										3,4	3,9	3,9*	3,9*	5,0		
	6,0 m								4,1*	4,1*	4,1*	4,1*	2,5	2,9	4,1*	4,1*								2,3	2,6	3,4*	3,4*	6,4					
	4,5 m								6,1*	6,1*	6,1*	6,1*	3,9	4,5	4,8*	4,8*	2,5	2,8	4,3*	4,3*				1,8	2,1	3,2	3,2*	7,2					
	3,0 m								3,6	4,2	6,0*	6,0*	2,4	2,7	4,1	4,8*	1,6	1,9	2,9	3,7*				1,6	1,9	2,9	3,2*	7,6					
	1,5 m								3,3	3,8	6,1	7,2*	2,2	2,6	4,0	5,3*	1,6	1,8	2,9	4,1				1,5	1,8	2,8	3,4*	7,6					
	0,0 m								3,1	3,7	5,9	7,7*	2,1	2,5	3,9	5,6*								1,6	1,8	2,9	3,8*	7,4					
	-1,5 m								5,6	6,8	9,1*	9,1*	3,1	3,6	5,9	7,5*	2,1	2,4	3,8	5,5*				1,8	2,0	3,2	4,5*	6,9					
	-3,0 m								3,2	3,7	6,0	6,5*												2,4	2,9	4,5	5,1*	5,4					
-4,5 m																																	
 5,1 m 2-piece boom 2,6 m dipper arm Rear dozer blade	7,5 m																										3,2	3,6*	3,6*	3,6*	5,2		
	6,0 m								4,0*	4,0*	4,0*	4,0*	2,6	2,9	4,0*	4,0*								2,2	2,5	3,2*	3,2*	6,5					
	4,5 m								4,0	4,5	4,7*	4,7*	2,5	2,9	4,1*	4,1*								1,7	2,0	3,0*	3,0*	7,3					
	3,0 m								3,6	4,2	5,9*	5,9*	2,3	2,7	4,2	4,7*	1,6	1,9	2,9	4,1*				1,5	1,8	2,8	3,0*	7,7					
	1,5 m								3,3	3,8	6,2	7,0*	2,2	2,6	4,0	5,2*	1,6	1,8	2,8	4,1				1,5	1,7	2,7	3,2*	7,8					
	0,0 m								4,6*	4,6*	4,6*	4,6*	3,1	3,6	5,9	7,6*	2,1	2,4	3,9	5,5*	1,5	1,8	2,8	4,1	1,5	1,8	2,8	3,5*	7,6				
	-1,5 m								5,6	6,7	8,8*	8,8*	3,1	3,6	5,9	7,5*	2,1	2,4	3,8	5,5*				1,7	2,0	3,1	4,1*	7,0					
	-3,0 m								3,1	3,7	6,0	6,6*												2,2	2,6	4,0	4,7*	5,8					
-4,5 m																																	
 5,1 m 2-piece boom 3,1 m dipper arm Rear dozer blade	7,5 m																										2,6	2,8*	2,8*	2,8*	5,9		
	6,0 m																											1,9	2,2	2,5*	2,5*	7,1	
	4,5 m																											1,5	1,8	2,4*	2,4*	7,8	
	3,0 m																											1,4	1,6	2,4*	2,4*	8,2	
	1,5 m																											1,3	1,5	2,4	2,5*	8,3	
	0,0 m																											1,3	1,6	2,5	2,8*	8,1	
	-1,5 m																											1,5	1,7	2,7	3,2*	7,6	
	-3,0 m																											1,8	2,1	3,3	4,1*	6,7	
-4,5 m																																	
 5,1 m 2-piece boom 2,95 m dipper arm for grab Rear dozer blade	7,5 m																											3,0	3,3	3,4*	3,4*	5,8	
	6,0 m																												2,2	2,5	3,0*	3,0*	7,0
	4,5 m																												1,9	2,1	2,9*	2,9*	7,7
	3,0 m																												1,7	1,9	2,8*	2,8*	8,1
	1,5 m																												1,6	1,9	2,8	2,9*	8,2
	0,0 m																												1,7	1,9	2,8	3,2*	8,0
	-1,5 m																												1,8	2,1	3,1	3,6*	7,5
	-3,0 m																												2,2	2,5	3,7	4,5*	6,5
-4,5 m																																	

Notes: 1. Working pressure with Power Boost = 36 MPa.









2. The above values are in compliance with ISO standard 10 567. They do not exceed 87 % of hydraulic lifting capacity or 75 % of tipping load, with the machine on firm, level ground.

3. Load capacities marked with an asterisk (*) are limited by machine's hydraulic lifting capacity rather than tipping load.

Lifting capacity

At the arm end, without bucket and quick fit. Unit: 1000 kg.

For lifting capacity including bucket/quick fit, simply subtract actual weight of those parts from the following values.









 Across under-carriage  Along under-carriage	Arm end (bucket pivot) related to ground level	Reach from machine centre (u = support up/d = support down)																								
		1,5 m		3,0 m				4,5 m				6,0 m				7,5 m				Max. reach						
		u	d	u	d	u	d	u	d	u	d	u	d	u	d	u	d	u	d	u	d	u	d	Max. m		
 4,75 m mono offset boom 2,0 m dipper arm Front dozer blade Rear outriggers	7,5 m																									
	6,0 m								4,3	4,6*	4,6*	4,6*									3,3*	3,3*	3,3*	3,3*	5,2	
	4,5 m								4,2	5,1*	5,1*	5,1*	2,6	3,9*	3,9*	3,9*					2,5	3,2*	3,2*	3,2*	6,2	
	3,0 m								3,9	6,2*	6,2*	6,2*	2,5	4,4	4,2	5,0*					2,2	3,3*	3,3*	3,3*	6,6	
	1,5 m								3,6	6,6	6,2	7,3*	2,4	4,3	4,0	5,5*					2,0	3,6	3,4	3,6*	6,7	
	0,0 m					5,9*	5,9*	5,9*	5,9*	3,4	6,4	6,0	7,8*	2,3	4,2	3,9	5,7*				2,1	3,7	3,5	4,3*	6,5	
	-1,5 m					6,1	10,8*	10,8*	10,8*	3,4	6,3	6,0	7,4*								2,4	4,3	4,1	5,5*	5,8	
	-3,0 m					6,3	8,5*	8,5*	8,5*	3,5	5,7*	5,7*	5,7*								3,4	5,6*	5,6*	5,6*	4,6	
	-4,5 m																									
 4,75 m mono offset boom 2,45 m dipper arm Front dozer blade Rear outriggers	7,5 m																									
	6,0 m																					2,6*	2,6*	2,6*	2,6*	5,7
	4,5 m								4,3	4,6*	4,6*	4,6*	2,7	4,1*	4,1*	4,1*					2,3	2,5*	2,5*	2,5*	6,6	
	3,0 m					7,1	8,7*	8,7*	8,7*	3,9	5,8*	5,8*	5,8*	2,5	4,4	4,2	4,7*				2,0	2,6*	2,6*	2,6*	7,0	
	1,5 m					4,9*	4,9*	4,9*	4,9*	3,6	6,6	6,2	7,0*	2,4	4,3	4,0	5,2*				1,8	2,8*	2,8*	2,8*	7,1	
	0,0 m					5,9	6,2*	6,2*	6,2*	3,4	6,3	6,0	7,6*	2,3	4,1	3,9	5,6*				1,9	3,3*	3,2	3,3*	6,9	
	-1,5 m	5,6*	5,6*	5,6*	5,6*	5,9	10,0*	10,0*	10,0*	3,3	6,3	5,9	7,6*	2,2	4,1	3,9	5,4*				2,1	3,8	3,6	4,3*	6,3	
	-3,0 m					6,1	9,5*	9,5*	9,5*	3,4	6,4	6,0	6,4*								2,8	5,2	4,9	5,3*	5,2	
	-4,5 m																									
 4,75 m mono offset boom 2,6 m dipper arm Front dozer blade Rear outriggers	7,5 m																									
	6,0 m																					2,4*	2,4*	2,4*	2,4*	5,9
	4,5 m								4,3	4,5*	4,5*	4,5*	2,7	3,9*	3,9*	3,9*					2,2	2,3*	2,3*	2,3*	6,7	
	3,0 m					7,2	8,4*	8,4*	8,4*	4,0	5,6*	5,6*	5,6*	2,6	4,4	4,2	4,6*				1,9	2,4*	2,4*	2,4*	7,2	
	1,5 m					5,6*	5,6*	5,6*	5,6*	3,6	6,6	6,3	6,9*	2,4	4,3	4,0	5,2*				1,8	2,6*	2,6*	2,6*	7,3	
	0,0 m					5,9	6,3*	6,3*	6,3*	3,4	6,4	6,0	7,6*	2,3	4,1	3,9	5,6*				1,8	3,1*	3,1*	3,1*	7,0	
	-1,5 m	5,4*	5,4*	5,4*	5,4*	5,9	9,6*	9,6*	9,6*	3,3	6,3	5,9	7,6*	2,2	4,1	3,9	5,5*				2,0	3,7	3,5	3,9*	6,4	
	-3,0 m					6,1	9,8*	9,8*	9,8*	3,3	6,3	6,0	6,6*								2,7	4,9	4,6	5,2*	5,4	
	-4,5 m																									
 4,75 m mono offset boom 3,1 m dipper arm Front dozer blade Rear outriggers	7,5 m																									
	6,0 m													2,7*	2,7*	2,7*	2,7*					1,9*	1,9*	1,9*	1,9*	6,5
	4,5 m													2,7	3,5*	3,5*	3,5*					1,9*	1,9*	1,9*	1,9*	7,2
	3,0 m					7,0*	7,0*	7,0*	7,0*	4,0	5,1*	5,1*	5,1*	2,6	4,3*	4,3	4,3*	1,8	2,4*	2,4*	2,4*	1,7	1,9*	1,9*	1,9*	7,6
	1,5 m					6,4	8,4*	8,4*	8,4*	3,6	6,4*	6,3	6,4*	2,4	4,3	4,1	4,9*	1,7	2,9*	2,9	2,9*	1,6	2,1*	2,1*	2,1*	7,7
	0,0 m					5,9	6,6*	6,6*	6,6*	3,4	6,4	6,0	7,3*	2,3	4,1	3,9	5,4*	1,6	2,4*	2,4*	2,4*	1,6	2,4*	2,4*	2,4*	7,5
	-1,5 m	4,7*	4,7*	4,7*	4,7*	5,8	8,7*	8,7*	8,7*	3,2	6,2	5,8	7,6*	2,2	4,0	3,8	5,5*				1,8	2,9*	2,9*	2,9*	7,0	
	-3,0 m	7,5*	7,5*	7,5*	7,5*	5,9	10,5*	10,5*	10,5*	3,2	6,2	5,9	7,0*								2,2	4,1	3,9	4,3*	6,0	
	-4,5 m																									
 4,75 m mono offset boom 2,0 m dipper arm Front and rear outriggers	7,5 m																									
	6,0 m								4,4	4,6*	4,6*	4,6*										3,3*	3,3*	3,3*	3,3*	5,2
	4,5 m								4,2	5,1*	5,1*	5,1*	2,7	3,9*	3,9*	3,9*					2,5	3,2*	3,2*	3,2*	6,2	
	3,0 m								3,9	6,2*	6,2*	6,2*	2,6	5,0*	4,2	5,0*					2,2	3,3*	3,3*	3,3*	6,6	
	1,5 m								3,6	7,3*	6,2	7,3*	2,4	5,3	4,0	5,5*					2,0	3,6*	3,4	3,6*	6,7	
	0,0 m					5,9*	5,9*	5,9*	5,9*	3,4	7,8*	6,0	7,8*	2,3	5,2	3,9	5,7*				2,1	4,3*	3,5	4,3*	6,5	
	-1,5 m					6,1	10,8*	10,8*	10,8*	3,4	7,4*	5,9	7,4*								2,4	5,5	4,1	5,5*	5,8	
	-3,0 m					6,3	8,5*	8,5*	8,5*	3,5	5,7*	5,7*	5,7*								3,4	5,6*	5,6*	5,6*	4,6	
	-4,5 m																									
 4,75 m mono offset boom 2,45 m dipper arm Front and rear outriggers	7,5 m																									
	6,0 m																					2,6*	2,6*	2,6*	2,6*	5,7
	4,5 m								4,3	4,6*	4,6*	4,6*	2,7	4,1*	4,1*	4,1*					2,3	2,5*	2,5*	2,5*	6,6	
	3,0 m					7,2	8,7*	8,7*	8,7*	4,0	5,8*	5,8*	5,8*	2,6	4,7*	4,2	4,7*				2,0	2,6*	2,6*	2,6*	7,0	
	1,5 m					4,9*	4,9*	4,9*	4,9*	3,6	7,0*	6,2	7,0*	2,4	5,2*	4,0	5,2*				1,9	2,8*	2,8*	2,8*	7,1	
	0,0 m					6,0	6,2*	6,2*	6,2*	3,4	7,6*	6,0	7,6*	2,3	5,2	3,9	5,6*				1,9	3,3*	3,2	3,3*	6,9	
	-1,5 m	5,6*	5,6*	5,6*	5,6*	6,0	10,0*	10,0*	10,0*	3,3	7,6*	5,9	7,6*	2,3	5,1	3,8	5,4*				2,1	4,3*	3,6	4,3*	6,3	
	-3,0 m					6,1	9,5*	9,5*	9,5*	3,4	6,4*	6,0	6,4*								2,8	5,3*	4,9	5,3*	5,2	
	-4,5 m																									

- Notes:
1. Working pressure with Power Boost = 36 MPa.
 2. The above values are in compliance with ISO standard 10 567. They do not exceed 87 % of hydraulic lifting capacity or 75 % of tipping load, with the machine on firm, level ground.
 3. Load capacities marked with an asterisk (*) are limited by machine's hydraulic lifting capacity rather than tipping load.

Lifting capacity

At the arm end, without bucket and quick fit. Unit: 1000 kg.

For lifting capacity including bucket/quick fit, simply subtract actual weight of those parts from the following values.









 Across under-carriage  Along under-carriage	Arm end (bucket pivot) related to ground level	Reach from machine centre (u = support up / d = support down)														Max. m									
		1,5 m		3,0 m		4,5 m		6,0 m		7,5 m		Max. reach													
		u	d	u	d	u	d	u	d	u	d	u	d	u	d										
 4,75 m mono offset boom 2,6 m dipper arm Front and rear outriggers	7,5 m																								
	6,0 m																			2,4*	2,4*	2,4*	2,4*	5,9	
	4,5 m								4,3	4,5*	4,5*	4,5*	2,7	3,9*	3,9*	3,9*				2,2	2,3*	2,3*	2,3*	6,7	
	3,0 m								7,3	8,4*	8,4*	8,4*	4,0	5,6*	5,6*	5,6*	2,6	4,6*	4,2	4,6*					7,2
	1,5 m								5,6*	5,6*	5,6*	5,6*	3,6	6,9*	6,2	6,9*	2,4	5,2*	4,0	5,2*					7,3
	0,0 m								6,0	6,3*	6,3*	6,3*	3,4	7,6*	6,0	7,6*	2,3	5,2	3,9	5,6*					7,0
	-1,5 m	5,4*	5,4*	5,4*	5,4*				6,0	9,6*	9,6*	9,6*	3,3	7,6*	5,9	7,6*	2,2	5,1	3,8	5,5*					6,4
	-3,0 m								6,1	9,8*	9,8*	9,8*	3,4	6,6*	5,9	6,6*									5,4
	-4,5 m																								
 4,75 m mono offset boom 3,1 m dipper arm Front and rear outriggers	7,5 m																								
	6,0 m																								
	4,5 m																								
	3,0 m																								
	1,5 m																								
	0,0 m																								
	-1,5 m	4,7*	4,7*	4,7*	4,7*																				
	-3,0 m	7,5*	7,5*	7,5*	7,5*																				
	-4,5 m																								
 4,75 m mono offset boom 2,0 m dipper arm Rear dozer blade	7,5 m																								
	6,0 m																								
	4,5 m																								
	3,0 m																								
	1,5 m																								
	0,0 m																								
	-1,5 m	4,7*	4,7*	4,7*	4,7*																				
	-3,0 m	7,5*	7,5*	7,5*	7,5*																				
	-4,5 m																								
 4,75 m mono offset boom 2,45 m dipper arm Rear dozer blade	7,5 m																								
	6,0 m																								
	4,5 m																								
	3,0 m																								
	1,5 m																								
	0,0 m																								
	-1,5 m	5,6*	5,6*	5,6*	5,6*																				
	-3,0 m																								
	-4,5 m																								
 4,75 m mono offset boom 2,6 m dipper arm Rear dozer blade	7,5 m																								
	6,0 m																								
	4,5 m																								
	3,0 m																								
	1,5 m																								
	0,0 m																								
	-1,5 m	5,4*	5,4*	5,4*	5,4*																				
	-3,0 m																								
	-4,5 m																								
 4,75 m mono offset boom 3,1 m dipper arm Rear dozer blade	7,5 m																								
	6,0 m																								
	4,5 m																								
	3,0 m																								
	1,5 m																								
	0,0 m																								
	-1,5 m	4,7*	4,7*	4,7*	4,7*																				
	-3,0 m	7,5*	7,5*	7,5*	7,5*																				
	-4,5 m																								

- Notes:
1. Working pressure with Power Boost = 36 MPa.
 2. The above values are in compliance with ISO standard 10 567. They do not exceed 87 % of hydraulic lifting capacity or 75 % of tipping load, with the machine on firm, level ground.
 3. Load capacities marked with an asterisk (*) are limited by machine's hydraulic lifting capacity rather than tipping load.

Lifting capacity

At the arm end, without bucket and quick fit. Unit: 1000 kg.

For lifting capacity including bucket/quick fit, simply subtract actual weight of those parts from the following values.









 Across under-carriage  Along under-carriage	Arm end (bucket pivot) related to ground level	Reach from machine centre (u = support up / d = support down)																											
		1,5 m		3,0 m		4,5 m		6,0 m		7,5 m		Max. reach																	
		u	d	u	d	u	d	u	d	u	d	u	d	u	d	u	d	Max. m											
 5,2 m 2-piece offset boom 2,0 m dipper arm Front dozer blade Rear outriggers	7,5 m																	*3,9	*3,9	*3,9	*3,9	4,4							
	6,0 m							4,3	*4,4	*4,4	*4,4								2,6	*3,4	*3,4	*3,4	5,9						
	4,5 m					*7,0	*7,0	*7,0	*7,0	4,0	*5,1	*5,1	*5,1	2,6	*4,4	4,3	*4,4		2,1	*3,2	*3,2	*3,2	6,8						
	3,0 m								3,7	*6,3	*6,3	*6,3	2,4	4,3	4,1	*4,8			1,8	3,2	3,1	*3,2	7,2						
	1,5 m								3,3	6,4	6,0	*7,2	2,3	4,2	3,9	*5,3			1,7	3,1	2,9	*3,5	7,3						
	0,0 m								3,2	6,2	5,8	*7,5	2,2	4,0	3,8	*5,5			1,7	3,2	3,0	*3,9	7,1						
	-1,5 m					5,8	*7,2	*7,2	*7,2	3,2	6,2	5,8	*7,2	2,2	4,0	3,8	*5,2			2,0	3,6	3,4	*4,7	6,5					
	-3,0 m																												
-4,5 m																													
 5,2 m 2-piece offset boom 2,45 m dipper arm Front dozer blade Rear outriggers	7,5 m							*4,0	*4,0	*4,0	*4,0												*3,0	*3,0	*3,0	*3,0	5,1		
	6,0 m								*3,9	*3,9	*3,9	*3,9	2,7	*3,8	*3,8	*3,8			2,3	*2,6	*2,6	*2,6	6,5						
	4,5 m					*5,8	*5,8	*5,8	*5,8	4,1	*4,7	*4,7	*4,7	2,6	*4,1	*4,1	*4,1			1,8	*2,5	*2,5	*2,5	7,2					
	3,0 m								3,7	*5,8	*5,8	*5,8	2,4	4,3	4,1	*4,6	1,7	3,0	2,9	*3,3	1,6	*2,6	*2,6	*2,6	7,6				
	1,5 m								3,3	6,4	6,0	*6,9	2,3	4,1	3,9	*5,1	1,6	3,0	2,8	*4,0	1,5	*2,7	2,7	2,7	7,8				
	0,0 m								3,1	6,1	5,8	*7,4	2,1	4,0	3,8	*5,4	1,6	2,9	2,8	*3,1	1,6	2,9	2,7	*3,0	7,5				
	-1,5 m					5,7	*6,6	*6,6	*6,6	3,1	6,1	5,7	*7,3	2,1	4,0	3,7	*5,3			1,7	3,2	3,1	*3,6	7,0					
	-3,0 m									3,2	6,2	5,8	*6,4								2,2	4,2	4,0	*4,6	5,9				
-4,5 m																													
 5,2 m 2-piece offset boom 2,6 m dipper arm Front dozer blade Rear outriggers	7,5 m								*3,8	*3,8	*3,8	*3,8													*2,8	*2,8	2,8	*2,8	5,3
	6,0 m									*3,8	*3,8	*3,8	*3,8	2,7	*3,7	*3,7	*3,7			2,2	*2,4	*2,4	*2,4	6,6					
	4,5 m								4,2	*4,5	4,5	*4,5	2,6	*4,0	*4,0	*4,0			1,8	*2,3	*2,3	*2,3	7,4						
	3,0 m								3,8	*5,7	*5,7	*5,7	2,5	4,4	4,1	*4,5	1,7	3,1	2,9	*3,5	1,6	*2,4	*2,4	*2,4	7,8				
	1,5 m								3,4	6,4	6,1	*6,8	2,3	4,2	3,9	*5,0	1,6	3,0	2,8	*4,1	1,5	*2,5	*2,5	*2,5	7,9				
	0,0 m								3,1	6,2	5,8	*7,4	2,1	4,0	3,8	*5,4	1,6	2,9	2,7	*3,9	1,5	*2,8	2,7	*2,8	7,7				
	-1,5 m					5,6	*6,4	*6,4	*6,4	3,1	6,1	5,7	*7,3	2,1	4,0	3,7	*5,4			1,7	*3,1	3,0	*3,3	7,1					
	-3,0 m									3,2	6,2	5,8	*6,5	2,2	4,0	3,8	*4,6			2,1	3,9	3,7	*4,3	6,2					
-4,5 m																													
 5,2 m 2-piece offset boom 3,1 m dipper arm Front dozer blade Rear outriggers	7,5 m																								*2,2	*2,2	*2,2	*2,2	6,0
	6,0 m													2,8	*3,2	*3,2	*3,2			1,9	*1,9	*1,9	*1,9	7,2					
	4,5 m								*3,7	*3,7	*3,7	*3,7	2,7	*3,6	*3,6	*3,6	1,8	*2,8	*2,8	*2,8	1,6	*1,9	*1,9	*1,9	7,9				
	3,0 m								3,9	*5,2	*5,2	*5,2	2,5	*4,2	4,2	*4,2	1,7	3,1	2,9	*3,6	1,4	*1,9	*1,9	*1,9	8,3				
	1,5 m								3,4	*6,4	6,1	*6,4	2,3	4,2	3,9	*4,8	1,6	3,0	2,8	*4,0	1,3	*2,0	*2,0	*2,0	8,4				
	0,0 m								*3,6	*3,6	*3,6	*3,6	3,1	6,2	5,8	*7,2	2,1	4,0	3,8	*5,2	1,5	2,9	2,7	*4,2	1,4	*2,2	*2,2	*2,2	8,2
	-1,5 m					5,5	*5,8	*5,8	*5,8	3,0	6,0	5,7	*7,3	2,0	3,9	3,7	*5,3	1,5	2,9	2,7	*3,5	1,5	*2,6	*2,6	*2,6	7,6			
	-3,0 m					5,6	*9,4	*9,4	*9,4	3,1	6,1	5,7	*6,8	2,1	3,9	3,7	*4,9			1,8	*3,3	3,2	*3,3	6,8					
-4,5 m																													
 5,2 m 2-piece offset boom 2,0 m dipper arm Front and rear outriggers	7,5 m																								*3,9	*3,9	*3,9	*3,9	4,4
	6,0 m								4,3	*4,4	*4,4	*4,4									2,7	*3,4	*3,4	*3,4	5,9				
	4,5 m					*7,0	*7,0	*7,0	*7,0	4,1	*5,1	*5,1	*5,1	2,6	*4,4	4,2	*4,4			2,1	*3,2	*3,2	*3,2	6,8					
	3,0 m								3,7	*6,3	*6,3	*6,3	2,4	*4,8	4,1	*4,8			1,8	*3,2	3,0	*3,2	7,2						
	1,5 m								3,4	*7,2	6,0	*7,2	2,3	5,2	3,9	*5,3			1,7	*3,5	2,9	*3,5	7,3						
	0,0 m								3,2	*7,5	5,8	*7,5	2,2	5,1	3,8	*5,5			1,8	*3,9	3,0	*3,9	7,1						
	-1,5 m					5,9	*7,2	*7,2	*7,2	3,2	*7,2	5,8	*7,2	2,2	5,1	3,8	*5,2			2,0	4,6	3,4	*4,7	6,5					
	-3,0 m																												
-4,5 m																													
 5,2 m 2-piece offset boom 2,45 m dipper arm Front and rear outriggers	7,5 m								*4,0	*4,0	*4,0	*4,0													*3,0	*3,0	*3,0	*3,0	5,1
	6,0 m									*3,9	*3,9	*3,9	*3,9	2,7	*3,8	*3,8	*3,8			2,3	*2,6	*2,6	*2,6	6,5					
	4,5 m					*5,8	*5,8	*5,8	*5,8	4,2	*4,7	*4,7	*4,7	2,6	*4,1	*4,1	*4,1			1,9	*2,5	*2,5	*2,5	7,2					
	3,0 m								3,8	*5,8	*5,8	*5,8	2,5	*4,6	4,1	*4,6	1,7	*3,3	2,9	*3,3	1,6	*2,6	*2,6	*2,6	7,6				
	1,5 m								3,4	*6,9	6,0	*6,9	2,3	*5,1	3,9	*5,1	1,6	3,7	2,8	*4,0	1,6	*2,7	2,7	2,7	7,7				
	0,0 m								3,2	*7,4	5,8	*7,4	2,2	5,1	3,8	*5,4	1,6	*3,1	2,7	*3,1	1,6	*3,0	2,7	*3,0	7,5				
	-1,5 m					5,7	*6,6	*6,6	*6,6	3,1	*7,3	5,7	*7,3	2,1	5,0	3,7	*5,3			1,8	*3,6	3,0	*3,6	7,0					
	-3,0 m									3,2	*6,4	5,8	*6,4								2,3	*4,6	3,9	*4,6	5,9				
-4,5 m																													

- Notes:
1. Working pressure with Power Boost = 36 MPa.
 2. The above values are in compliance with ISO standard 10 567. They do not exceed 87 % of hydraulic lifting capacity or 75 % of tipping load, with the machine on firm, level ground.
 3. Load capacities marked with an asterisk (*) are limited by machine's hydraulic lifting capacity rather than tipping load.

Lifting capacity

At the arm end, without bucket and quick fit. Unit: 1000 kg.

For lifting capacity including bucket/quick fit, simply subtract actual weight of those parts from the following values.

 Across under-carriage  Along under-carriage	Arm end (bucket pivot) related to ground level	Reach from machine centre (u = support up/d = support down)																								
		1,5 m		3,0 m		4,5 m		6,0 m		7,5 m		Max. reach														
		u	d	u	d	u	d	u	d	u	d	u	d	u	d	u	d	Max. m								
 5,2 m 2-piece offset boom 2,6 m dipper arm Front and rear outriggers	7,5 m							*3,8	*3,8	*3,8	*3,8							*2,8	*2,8	*2,8	*2,8	5,3				
	6,0 m							*3,8	*3,8	*3,8	*3,8	2,7	*3,7	*3,7	*3,7				2,2	*2,4	*2,4	*2,4	6,6			
	4,5 m							4,2	*4,5	*4,5	*4,5	2,6	*4,0	*4,0	*4,0				1,8	*2,3	*2,3	*2,3	7,4			
	3,0 m							3,8	*5,7	*5,7	*5,7	2,5	*4,5	4,1	*4,5	1,7	*3,5	2,9	*3,5	1,6	*2,4	*2,4	*2,4	7,8		
	1,5 m							3,4	*6,8	6,0	*6,8	2,3	*5,0	3,9	*5,0	1,6	3,7	2,8	*4,1	1,5	*2,5	*2,5	*2,5	7,9		
	0,0 m							3,2	*7,4	5,8	*7,4	2,2	5,1	3,8	*5,4	1,6	3,7	2,7	*3,9	1,5	*2,8	2,7	*2,8	7,7		
	-1,5 m				5,7	*6,4	*6,4	*6,4	3,1	*7,3	5,7	*7,3	2,1	5,0	3,7	*5,4				1,7	*3,3	2,9	*3,3	7,1		
	-3,0 m								3,2	*6,5	5,8	*6,5	2,2	*4,6	3,8	*4,6				2,1	*4,3	3,7	*4,3	6,2		
-4,5 m																										
 5,2 m 2-piece offset boom 3,1 m dipper arm Front and rear outriggers	7,5 m																	*2,3	*2,3	*2,3	*2,3	6,0				
	6,0 m																		2,8	*3,2	*3,2	*3,2	7,2			
	4,5 m								*3,7	*3,7	*3,7	*3,7	2,7	*3,6	*3,6	*3,6	1,8	*2,8	*2,8	*2,8	1,6	*1,9	*1,9	*1,9	7,9	
	3,0 m								3,9	*5,2	*5,2	*5,2	2,5	*4,2	4,2	*4,2	1,7	*3,6	2,9	*3,6	1,4	*1,9	*1,9	*1,9	8,3	
	1,5 m								3,5	6,4	6,1	6,4	2,3	*4,8	3,9	*4,8	1,6	3,7	2,8	*4,0	1,4	*2,0	*2,0	*2,0	8,4	
	0,0 m								*3,6	*3,6	*3,6	*3,6	3,2	*7,2	5,8	*7,2	2,1	5,1	3,8	*5,2	1,5	3,6	2,7	*4,2	8,2	
	-1,5 m				5,6	*5,8	*5,8	*5,8	3,1	*7,3	5,6	*7,3	2,1	5,0	3,7	*5,3	1,5	*3,5	2,7	*3,5	1,5	*2,6	*2,6	*2,6	7,6	
	-3,0 m								*5,7	*9,4	*9,4	*9,4	3,1	*6,8	5,7	*6,8	2,1	*4,9	3,7	*4,9						6,8
-4,5 m																										
 5,2 m 2-piece offset boom 2,0 m dipper arm Rear dozer blade	7,5 m																									
	6,0 m																									
	4,5 m																									
	3,0 m																									
	1,5 m																									
	0,0 m																									
	-1,5 m																									
	-3,0 m																									
-4,5 m																										
 5,2 m 2-piece offset boom 2,45 m dipper arm Rear dozer blade	7,5 m																									
	6,0 m																									
	4,5 m																									
	3,0 m																									
	1,5 m																									
	0,0 m																									
	-1,5 m																									
	-3,0 m																									
-4,5 m																										
 5,2 m 2-piece offset boom 2,6 m dipper arm Rear dozer blade	7,5 m																									
	6,0 m																									
	4,5 m																									
	3,0 m																									
	1,5 m																									
	0,0 m																									
	-1,5 m																									
	-3,0 m																									
-4,5 m																										
 5,2 m 2-piece offset boom 3,1 m dipper arm Rear dozer blade	7,5 m																									
	6,0 m																									
	4,5 m																									
	3,0 m																									
	1,5 m																									
	0,0 m																									
	-1,5 m																									
	-3,0 m																									
-4,5 m																										

- Notes:
1. Working pressure with Power Boost = 36 MPa.
 2. The above values are in compliance with ISO standard 10 567. They do not exceed 87 % of hydraulic lifting capacity or 75 % of tipping load, with the machine on firm, level ground.
 3. Load capacities marked with an asterisk (*) are limited by machine's hydraulic lifting capacity rather than tipping load.

STANDARD EQUIPMENT

Engine

Turbocharged, 4 stroke Volvo diesel engine with water cooling, direct injection and charged air cooler that meets EU Step IIIA emission requirements
Intake air pre-heater
Electric engine shut-off
Fuel filter and water separator
Fuel filler pump: 50 l/min with automatic shut-off
Aluminium core radiator

Electric/ Electronic control system

Contronics-computerized monitoring and diagnostic system
Master electrical disconnect switch
Automatic idling system
One-touch power boost
Adjustable monitor
Engine restart prevention circuit
Safety stop/start function
High capacity halogen lamps
– Frame mounted 2
– Cab mounted 2
Alternator, 80 A
Batteries, 2 x 12 V/140 Ah
Start motor, 24 V/4,8 kW

Undercarriage

2-speed power transmission plus creep speed
Oscillating front axle $\pm 9^\circ$
2-circuit travel brakes
Maintenance-free propeller shafts

Superstructure

Counterweight, 3 200 kg
Service walkway with anti-slip grating
Centralised lubricating point for slew bearing

Digging equipment

Attachment points for extra hydraulics
Centralised lubrication point

Cab and interior

Volvo Care Cab with fixed PC roof hatch
Heater
Hydraulic dampening cab mounts
Adjustable operator seat and joystick control console
Adjustable steering wheel
Flexible antenna
Hydraulic safety lock lever
Control joystick, with 5 switches each

Cab, all-weather sound suppressed, includes:

- Cup holder
- Door locks
- Safety glass, light tinted
- Floor mat
- Horn
- Large storage area
- Pull-up type front window
- Removable lower windshield
- Seat belt
- Windshield wiper with washer and intermittent feature
- Sun shield, front
- Master ignition key

Hydraulic system

Load sensing hydraulic system
Cylinder cushioning
Cylinder contamination seals
Return filter of full flow type 2 000 h exchange interval
Pressure relief system (servo accumulator)
Thermostatically controlled cooling fan
Hose rupture valve for boom
Hydraulic oil, ISO VG46

OPTIONAL EQUIPMENT

Engine

Diesel coolant heater with digital timer
Block heater, 240 V
Water separator with heater
Dust net

Electric

Travel alarm
Rotating beacon
Extra work lights:
– Service walkway 1 and counterweight 1
– Boom-mounted 2
– Cab front 2
Electric centre passage
Rear view camera
CareTrack via GSM
CareTrack via satellite
Anti-theft system
Tilting and rotating attachment preparation

Hydraulic system

Hose rupture valve for dipper arm
Boom float function
Hydraulic oil, ISO VG 32
Hydraulic oil, ISO VG 68
Hydraulic oil, biodegradable 32
Hydraulic oil, biodegradable 46
Hydraulic long life oil 32
Hydraulic long life oil 46
Hydraulic long life oil 68
Hydraulic equipment for:
– Hammer & shears
– Slope bucket/rotator
– Grab/clam shell
– Quick fit

- Flow control
- Flow and pressure control

Cab and interior

Volvo Care Cab with openable PC roof hatch
Heater & air-conditioner, automatic
Proportional control joystick
On/off joystick
Falling object guard (FOG)
Cab mounted falling object protective structures (FOPS)
Rain shield, front
Sun shield, roof & rear
Sunlight protection, roof hatch (steel)
Safety net for front window
Lower wiper
Anti-vandalism kit
Radio & cassette
Radio with CD player and MP3 input
Ashtray
Lighter
Seat:
– Fabric seat, with heater
– Fabric seat, with heater and air suspension
Retractable seat belt
Comfort Drive Control, CDC

Undercarriage

Twin tires 10.00 – 20 / 11.00 – 20
Single tires 18R – 19.5 / 600/40-22.5
Sparewheel
Stone protection rings
Front dozer blade and rear outriggers
Rear dozer blade
Front outriggers and rear dozer blade
4 outriggers

Grab holder
Mudguards, front/rear
Tool box, left hand side/right hand side
Cruise control
Travel speed 20 km/h, 30 km/h, 35 km/h
Wide axle 2,75 m

Digging equipment

Booms
5,0 m monoblock
5,1 m 2-piece boom
4,75 m mono offset boom
5,2 m 2-piece offset boom

Dipper arms
2,0 m, 2,45 m, 2,6 m, 3,1 m
2,95 m grab arm

Hydraulic quick fit

S1 system
S6 system
Universal system

Attachments

Buckets, direct fit and quick fit:
– General Purpose bucket (GP)
– Heavy Duty bucket
– Slope bucket
– Hammer bracket, direct fit, S6 and universal system
– Grab holder, S6

Service

Tool kit, daily maintenance
Tool kit, full scale

Standard and optional equipment may vary by market. Please consult your local Volvo dealer for details.



Volvo Construction Equipment is different. Our machines are designed, built and supported in a different way. That difference comes from an engineering heritage of over 175 years. A heritage of thinking first about the people who actually use the machines. About how to help them be safer, more comfortable, more productive. About the environment we all share. The result of that thinking is a growing range of machines and a global support network dedicated to helping you do more. People around the world are proud to use Volvo. And we're proud of what makes Volvo different – **More care. Built in.**



Not all products are available in all markets. Under our policy of continuous improvement, we reserve the right to change specifications and design without prior notice. The illustrations do not necessarily show the standard version of the machine.

VOLVO

Volvo Construction Equipment
www.volvo.com

Ref. No. 21 C 100 2831
Printed in Sweden 2008.08-2.0
Volvo, Konz

English
EXC